

MARINE PRODUCT DATA SHEET

OEM: 357-014-00 (600 GPH)
AFTERMARKET: 357-014-10 (600 GPH)

APPLICATION

12V DC Bait/Livewell tanks water circulation

PUMP

Type: Centrifugal Pump
Outlet Port: 3/4" Barb
Inlet Port: 3/4" NPS-M
Liquid: 130 °F [54 °C] Max
Prime: Flooded Inlet
Inlet PSI: 30 PSI [2.1 Bar] Max
Run Dry: No

ELECTRICAL

Motor: 12VDC Permanent Magnet,
Continuous Duty
Protection: Need External Fuse (Not supplied)
Leads: 6 ft [1.8M] Tinned, 16 AWG
Fuse: 3 Amp Recommended
Control: No Control

MATERIALS

Housing: High Strength Nylon
Impeller: High Strength Nylon
Hardware: Stainless Steel

APPROVALS

Ignition Protected 8846, CE

SHIPPING

Approx. Net Weight: 1.5 Lbs. [0.68 Kg] each
Approx. Lbs./Ctn. 16 Lbs. [7.2 Kg]
Pumps in Carton: 12
Approx. Carton Size: 24"L x 18"W x 11" H
[61cm x 46 cm x 28 cm]

RELATED DOCUMENTS

Catalog: MS-030-140
Applications Spec Guide: MS-020-005
Installation Manual: 911-611
Aftermarket Warranty: 911-1045



Everything you are looking for in an aerator pump. Our tough, high density nylon housing and heavy duty water cooled motor give the SHURflo Aerator Pumps unparalleled reliability. Patented anti-airlock feature allows the pump to clear trapped air in rough water or when the boat is anchored. All Piranha Series Aerator Pumps have a removable cartridge for easy cleaning.

Replacement Kit

94-619-00

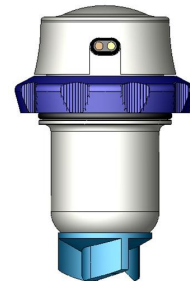

TYPICAL PERFORMANCE

PRESSURE		FLOW		CURRENT
METERS	FT OF HEAD	GPH	LPH	AMPS
0.0	0	620	2346	1.4
1.2	4	210	794	1.5
2.4	8	0.0	0.0	1.3

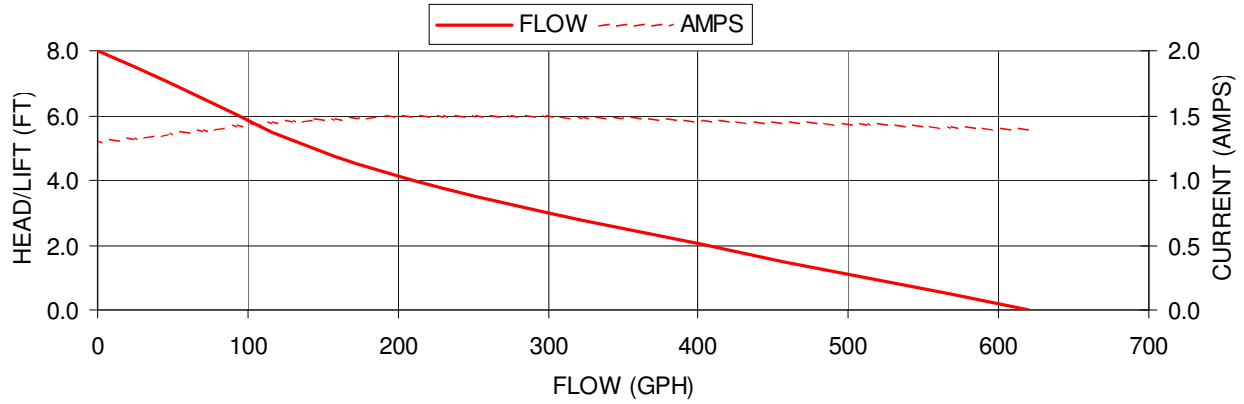

DIMENSIONS [mm]

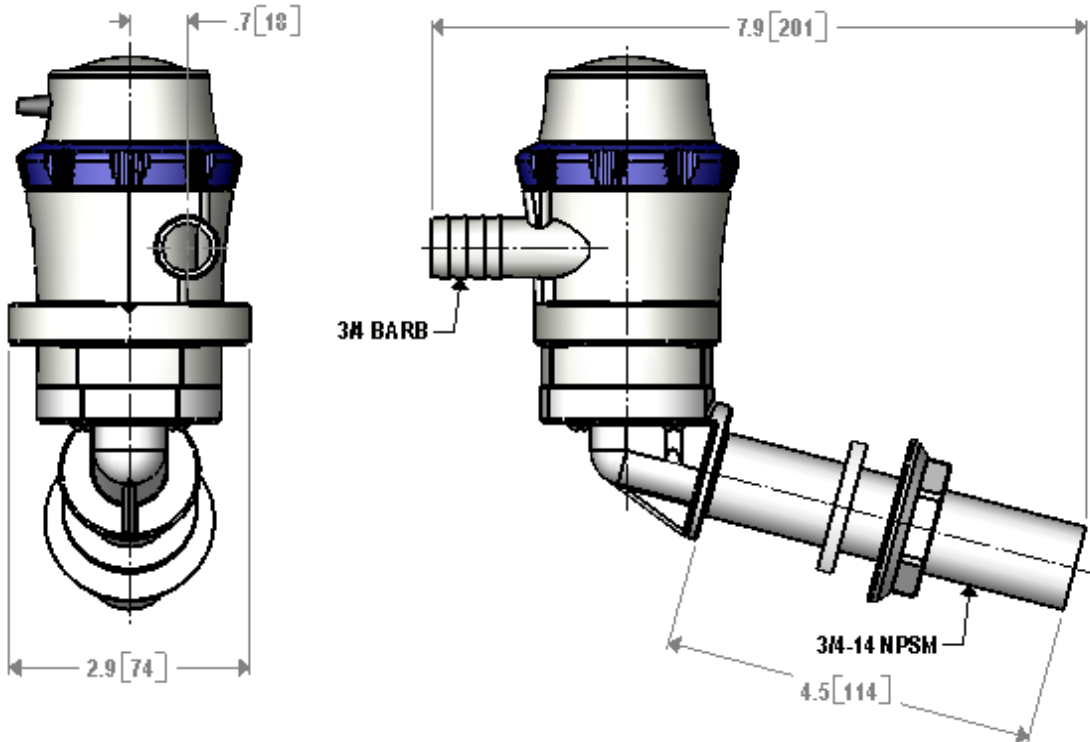

FLOW MANAGEMENT SOLUTIONS

3545 Harbor Gateway South, Suite 103, Costa Mesa, CA 92626, (800) 854-3218 www.SHURFLO.com

All Pentair trademarks and logos are owned by Pentair, Inc. All other brand or product names are trademarks or registered marks of their respective owners. Because we are continuously improving our products and services, Pentair reserves the right to change specifications without prior notice. Pentair is an equal opportunity employer.