



# ACU-TROL<sup>®</sup> CHEMICAL CONTROLLER FOR POOL AND SPA MODEL AK110



## INSTALLATION AND USER'S GUIDE



IMPORTANT SAFETY INSTRUCTIONS  
*READ AND FOLLOW ALL INSTRUCTIONS*  
SAVE THESE INSTRUCTIONS

## CUSTOMER SERVICE / TECHNICAL SUPPORT

---

If you have questions about ordering Pentair Aquatic Systems replacement parts, and pool products, please contact:

**Customer Service and Technical Support, USA**

(8 A.M. to 4:30 P.M. — Eastern/Pacific Times)

Phone: (800) 831-7133

Fax: (800) 284-4151

**Web site**

Visit [www.pentairpool.com](http://www.pentairpool.com) or [www.staritepool.com](http://www.staritepool.com)

**Sanford, North Carolina** (8 A.M. to 4:30 P.M. ET)

Phone: (919) 566-8000

Fax: (919) 566-8920

**Moorpark, California** (8 A.M. to 5 P.M. PT)

Phone: (805) 553-5000 (Ext. 5591)

Fax: (805) 553-5515

## CONTENTS

SECTION 1 INFORMATION	
IMPORTANT WARNING AND SAFETY INSTRUCTIONS .....	5-6
CONTROLLER OVERVIEW.....	7
SECTION 2 INSTALLATION	
INSTALLATION PREPARATION .....	8
INSTALLATION SUMMARY .....	8
MOUNTING INSTRUCTIONS.....	9
ELECTRICAL SPECIFICATIONS .....	10
INPUT VOLTAGE SELECTION.....	10
CONNECTING POWER.....	10
ELECTRICAL LOADS.....	11
RELAY BOARD.....	12
CHEMICAL FEED PUMP LOCATION .....	13
HEATER INSTALLATION .....	13
PLUMBING INSTALLATION .....	14
SECTION 3 HARDWARE	
MODULES .....	16
SENSOR MODULES.....	16
COMMUNICATION MODULES .....	16
RELAY MODULES.....	16
SECTION 4 AK1200 FLOW CELL	
AK1200 FLOW CELL .....	18
FLOW CELL ASSEMBLY .....	19
FLOW CELL MOUNTING.....	19
INLET AND EXIT LINES .....	19
SENSORS .....	19
SECTION 5 SENSORS	
pH AND ORP SENSORS.....	21
CALCULATED PPM .....	22
AKCOLOR PPM .....	22
TEMPERATURE SENSOR .....	22
FLOW SENSORS.....	22
SENSOR CARE.....	23
FINISHING AND TESTING THE INSTALLATION .....	23
SECTION 6 OPERATIONS	
CONTROLLER WINDOW NAVIGATION .....	24
SELECTING ITEMS IN THE WINDOWS .....	25
MAKING CHANGES.....	25
START UP .....	26
INITIALIZING THE CONTROLLER.....	26
POWER UP SCREEN .....	26
DISPLAY SCREEN.....	27
THE DISPLAY SCREEN .....	27
CALIBRATING TEMPERATURE.....	27
CALIBRATING pH.....	28
CALIBRATING ORP .....	28
CALIBRATING CALCULATED PPM.....	29
MANUAL RELAY CONTROL .....	29
RELAY TIME DISPLAY .....	30
SET UP FLOW .....	30
CONFIGURATION MENU .....	31
NAME.....	32
SYSTEM.....	32

---

CONTENTS (Continued)

PROGRAMMING .....	33
SERVICE .....	35
DATA .....	35
COMMUNICATIONS .....	36
PAGER SETUP SCREENS .....	36
EMAIL SETUP .....	37
SECURITY .....	37
WIZARDS .....	38
SECTION 7 TROUBLESHOOTING	
COMMON PROBLEMS .....	39
REAL TIME CLOCK .....	39
ORP TROUBLESHOOTING .....	40
USING THE TEST STRIP .....	40
AKCOLOR PPM TROUBLESHOOTING .....	41
pH TROUBLESHOOTING .....	41
SECTION 8 APPENDIXES	
UTILITY PASSWORDS 9000-9020 .....	42
SET-UP DIGITAL FLOW .....	42
PROPORTIONAL FEED .....	42
SECTION 9 WIRING DIAGRAMS	
RELAY WIRING DIAGRAMS .....	43
SENSOR WIRING DIAGRAMS .....	44
SECTION 10 MENUS	
SCREEN NAVIGATION KEYS .....	45
MAIN STATUS SCREEN NAVIGATIONS .....	46
RELAY AND ALARM TIMER SCREEN NAVIGATION .....	50
CONFIGURATION MENU SCREEN NAVIGATION .....	52
CONTROLLER NAME SCREEN NAVIGATION .....	54
SYSTEM SETUP SCREEN NAVIGATION .....	56
PROGRAMMING SCREEN NAVIGATION , pH MIX TIME .....	58
PROGRAMMING SCREEN NAVIGATION, pH CYCLE TIME .....	60
PROGRAMMING SCREEN NAVIGATION, ORP MIX TIME .....	62
PROGRAMMING SCREEN NAVIGATION, ORP CYCLE TIME .....	66
PROGRAMMING SCREEN NAVIGATION, ORP CAL HYPO .....	70
PROGRAMMING SCREEN NAVIGATION, PPM CYCLE TIME .....	74
PROGRAMMING SCREEN NAVIGATION, PMM MIX TIME .....	78
PROGRAMMING SCREEN NAVIGATION, PROBE CLEAN .....	82
PROGRAMMING SCREEN NAVIGATION, HEATER .....	84
PROGRAMMING SCREEN NAVIGATION, ALARM OUT .....	96
PROGRAMMING SCREEN NAVIGATION, AUX. MAKE-UP (AUTO-FILL) .....	90
PROGRAMMING SCREEN NAVIGATION, DAILY EVENT .....	92
PROGRAMMING SCREEN NAVIGATION, WEEKLY EVENT .....	96
PROGRAMMING SCREEN NAVIGATION, FRONT PANEL ALARM .....	96
PROGRAMMING SCREEN NAVIGATION, PAGER .....	100
PROGRAMMING SCREEN NAVIGATION, EMAIL .....	104
WIZARDS SETUP SCREEN NAVIGATION .....	108
DATA SCREEN NAVIGATION .....	112
COMMUNICATIONS SCREEN DIAL-UP .....	114
COMMUNICATIONS SCREEN INTERNET MODEMS .....	118
SECURITY SETUP SCREEN NAVIGATION .....	124
AKCOLOR SCREEN NAVIGATION .....	126
SERVICE SCREEN NAVIGATION .....	128
AK110 CHEMICAL CONTROLLER ILLUSTRATED PARTS LIST .....	130

## IMPORTANT WARNING AND SAFETY INSTRUCTIONS



**SERIOUS BODILY INJURY OR DEATH CAN RESULT IF THIS PRODUCT IS NOT INSTALLED AND USED CORRECTLY.**



**INSTALLERS, POOL OPERATORS AND POOL OWNERS MUST READ THESE WARNINGS AND ALL INSTRUCTIONS BEFORE USING THIS PRODUCT.**



Most states and local codes regulate the construction, installation, and operation of public pools and spas, and the construction of residential pools and spas. It is important to comply with these codes, many of which directly regulate the installation and use of this product. Consult your local building and health codes for more information.



**IMPORTANT NOTICE - Attention Installer:** This Installation and User's Guide ("Guide") contains important information about the installation, operation and safe use of this product. This Guide should be given to the owner and/or operator of this product.

**DO NOT INSTALL THE AK110 CHEMICAL CONTROLLER WHERE IT CAN BE READILY ACCESSIBLE TO THE PUBLIC.**



Before installing this product, read and follow all warning notices and instructions in this Guide. Failure to follow warnings and instructions can result in severe injury, death, or property damage. Call (800) 831-7133 for additional free copies of these instructions.



### **RISK OF ELECTRICAL SHOCK OR ELECTROCUTION:**

**BEFORE WORKING ON THE AK110 CHEMICAL CONTROLLER: Always disconnect power to the IntelliChem controller at the circuit breaker before servicing. Failure to do so could result in death or serious injury to service person, pool users or others due to electric shock.**

**BE SURE TO DISCONNECT ALL SUPPLY CONNECTIONS BEFORE SERVICING.**



This product must be installed by a licensed or certified electrician or a qualified pool professional in accordance with the National Electrical Code (NEC), NFPA 70 or the Canadian Electrical Code (CEC), CSA C22.2. All applicable local installation codes and ordinances must also be adhered to. Improper installation will create an electrical hazard which could result in death or serious injury to pool users, installers or others due to electrical shock, and may also cause damage to property.



**BEFORE USING YOUR POOL, SPA OR HOT TUB, CHECK THE pH AND SANITIZER LEVELS OF THE WATER.**



**Do not permit children to operate this equipment.**



When mixing acid with water, ALWAYS ADD ACID TO WATER. NEVER ADD WATER TO ACID. When adding any chemical to the pool/spa, be sure to follow the manufacturer's instructions thoroughly.



**DO NOT MIX SODIUM HYPOCHLORITE AND MURATIC ACID**



Risk of electrical shock. Connect AK110 Chemical Controller to a ground-fault interrupter-circuit (GFCI). Contact a qualified electrician if you cannot verify that the receptacle is protected by a GFCI.



**IF "CLEAR OVERFEED LIMIT" SETTING IS SET TO 24 HOURS, DO NOT SET "FEED TIME" GREATER THAN 20 HOURS AS THIS WILL VOID NSF CERTIFICATION.**

## IMPORTANT WARNING AND SAFETY INSTRUCTIONS

### WARNING

**WARNING CHEMICAL BURN HAZARD:** Make sure all pumps are switched off at the main circuit breakers at the house before drilling into any pipes. Securely fasten all electrical, water and chemical lines. Locate chemical feed pumps and chemical storage tanks in a safe and secure area.

### WARNING

Strictly follow the acid manufacturers safety and handling protocols including hand, body and eye protection when transferring or handling acid. Safety precautions should be used when handling Muriatic acid to control pH water levels. Muriatic acid can cause serious body injury and damage pool equipment. Extra care must be taken when installing, maintaining and operating acid pump feed systems. Acid is dangerous to handle and should be properly contained, transported, poured, stored, and dispensed.

### WARNING

Check the pH and sanitizer levels of the water before use.

Periodically use an independent pH and Chlorine test kit to verify that pH and chlorine is at a safe level. If the pH and Oxidation Reduction Potential (ORP) or Flow Cell sensors are broken, depleted or dirty with oils, lotions, or other contaminants, they can report inaccurate results to the system causing incorrect water chemistry, which could harm people or equipment.

Check the IntelliChem main status display each day to ensure there are no Alarm messages. See “Troubleshooting” section for more information. installing, maintaining and operating acid pump feed systems. Acid is dangerous to handle and should be properly contained, transported, poured, stored, and dispensed.

## GENERAL WARNINGS AND SAFETY PRECATIONS

PLEASE READ THIS USER MANUAL completely before installing or operating the equipment. The Controller Pool and Spa Chemical Controller is a Class 1 product for protection against electric shock and a Type 1 product with regard to disconnection of the control circuits.

Be sure to observe the following safety precautions:

- Do not permit anyone untrained or under the age of 18 to use this product.
- Unit must be properly grounded.
- Front panel must be closed before power is applied.
- Always turn OFF main circuit breaker to unit and all equipment before servicing.
- Touching the controller's internal parts could result in injury and or damage to the controller. In case of a malfunction, only a qualified technician should repair the controller.
- Risk of Electric Shock. Connect only to a grounding type receptacle protected by a ground-fault circuit interrupter (GFCI).
- Do not bury cord. Route cord to eliminate external damage.
- Be careful not to damage any of the insulation on wires or the power cord. Should the cord be damaged, return it to your dealer for a replacement. Continued use could result in fire or electric shock.
- To reduce the risk of electric shock, do not use an extension cord to connect unit to electric supply, provide a properly located GFCI.
- Never remove or install any cables on the circuit cards when power is applied, damage to the components may occur.

### **WARNING** **CHEMICAL BURN HAZARD**

Make sure pumps are OFF before drilling into pipes.  
Securely fasten all electrical, water and chemical lines. Locate chemical feed pumps and chemical storage tanks in a safe and secure area.

### **WARNING** **CHEMICAL HAZARD CONDITION**

**DO NOT TURN CHEMICAL FEED PUMPS ON WHEN BOTH FLOW  
CELL VALVES ARE CLOSED.**

---

## AK110 Pool and Spa Chemical Controller Overview

The AK110PS Pool and Spa Chemical Controller ("Controller") is a microprocessor based modular automation system capable of continuous local or remote monitoring and control of water chemistry for pool and spa applications. The Controller will maintain the pH and sanitizer levels of your water system automatically. Customized applications are possible with the addition of optional expansion modules.

**MODULAR:** The Controller is designed to grow with the needs of the customer. There are optional modules that can be installed as the need arises without having to remove the Controller from the wall.

**INTERFACE:** The Controller uses a built-in keypad with 16 buttons, and an easy to read 80 character liquid crystal display. The display's internal back-light provides viewing in low light conditions. The back-light illumination time can be adjusted to suit the operator.

**MENUS:** The Controller features easy to use display menus for on screen navigation.

**MEMORY:** In case of power loss, all set-points and programming are retained in nonvolatile memory. These values will be protected for a minimum ten (10) years without having power applied.

**DATA RECORDING:** The Controller has the ability to record data at 2 hour time intervals. Over 1 month of data can be recorded before filling up the memory. When the memory is full the new data will overwrite the oldest data.

**RELAYS:** The Controller can control up to three (3) relays. There are various types of relay configurations available to different types of load requirements.

**DISPLAYS:** The Controller can display measurements, relay ON/OFF states, length of time that relays have been on and the alarm status.

**SENSORS:** The Controller can measure readings and control based on inputs from the following sensors: temperature, digital flow, pH, ORP, and AKColor PPM.

**VOLTAGE:** The Controller includes a switch to select the input voltage of 110 or 220 VAC (single or dual phase).

**HEALTH:** The Controller can be configured to maintain the bacteriological and physiological requirements of state and local health departments. In addition, the Controller has the capability to be configured such that equipment can be protected from the effects of improper water balance.

**REMOTE MONITORING:** The Controller can be easily configured for remote, full duplex communication using an internal 56K modem and a phone line, or a wireless modem and an internet connection. This feature allows a user remote access to Controller operations using an MS Windows Based PC and the Acu-Com Software. The Acu-Com Software is a full featured software package that allows the operator to download recorded data, monitor system inputs in real time and provides a graphing option that allows for detailed analysis of water system parameters and performance. In addition, AcuManage II, an online database management system will display data from any internet enabled Controller.

**REMOTE PAGING:** With the optional modem installed, the Controller can be programmed to dial out to electronic paging systems for notifying operators of an alarm condition.

**REMOTE EMAILING:** With the optional wireless modem installed, the Controller can be programmed to send an email notifying operators of an alarm condition.

**SECURITY:** The Controller provides two level security protection based on passwords for both local and remote interaction.

---

## **SECTION 2 INSTALLATION**

### **Installation Preparation**

Inspection: Upon receiving the Controller check the carton carefully. Report any shipping damage to shipping company. Examine the enclosed shipping list and verify that all items are present. Contact Customer Support (800) 831.7133 if any items are missing or have been damaged. Use care when unpacking equipment to avoid damage or loss of small parts. Verify that the fuses are the correct values and that the voltage select switch is in the proper position.

### **Installation Summary**

The following steps are required to install the Controller:

1. Identify new and existing equipment to be connected.
2. Decide if the sensors will be in-line, in a separate by-pass line, or if the AK1200 flow cell will be used. Caution: If the AK1200 flow cell is used, the input water maximum pressure is 25 PSI.
3. Determine the supply voltage, 110 VAC or 220 VAC, and set the supply voltage switch as necessary.
4. Determine if the control to the equipment uses the same voltage as the supply voltage. All controlled equipment must be compatible.
5. Determine the water-tap points for the flow cell bypass inlet and outlet.
6. Mount the Controller away from direct sunlight and on a flat vertical surface.
7. Connect the supply voltage with main breaker off. (Must be a separate dedicated circuit GFCI).
8. If using an AK1200 flow cell install the bypass now.
9. Connect the sensors.
10. Test the plumbing for leaks.
11. Turn on the Controller for the first time.
12. Test the equipment, using the Controller manual relay mode.
13. Calibrate the probes, then re-calibrate as the probes acclimate to the system. Acclimation can take as little as two hours or as long as 24 hours.
14. Program the Controller.
15. Call or visit the controller over the next few days to insure the system is balanced and in control. Fine-tune the setup if necessary.



---

## Mounting Instructions

Select a location for mounting the Controller, meeting the following recommendations:

1. Mount at least ten (10) feet from open water.
2. Mount close enough for the supplied power cord to reach the supply voltage. The Controller will not operate properly without a solid earth ground connection.

### **WARNING**

**Proper and safe operation requires an earth ground connection.**

3. Supply power must be routed to the Controller in accordance with the applicable codes in the area; the supplied power cord is not code in some areas.
4. The installation surface must be solid and vertical. Do not mount the Controller in a horizontal position.

### **WARNING**

**Keep the Controller out of direct sunlight, inside a room if possible. Direct sunlight on the Controller will result in inaccurate readings. A shade screen should be used for outdoor installations.**

5. Maintain adequate clearance for opening the front panel enclosure.
6. The environment should be free of chemical fumes and excessive heat. The maximum room temperature is should not exceed 110 °F.
7. Mount as far as possible from sources of electrical interference.
8. Install the four mounting feet as desired to the Controller back and prepare the hole to the mounting surface as desired.
9. Hold the Controller against the mounting surface with a closed lid and mark the location of the mounting bracket located on the top of the Controller next to the wall. Prepare holes as necessary and secure Controller using hardware provided.
10. Mount on a flat surface. Controller box will distort if mounted on an uneven surface.
11. Pre-install screws with  $\frac{1}{4}$  left out on bottom so that the Controller can slide into them. Install the remaining side screws and tighten.

## Electrical Specifications

The following electrical specifications in the table below must not be exceeded.

ITEM	DESCRIPTION	LIMIT
Input Voltage	Maximum Input AC Voltage	250 VAC
Input Current	Maximum Input Current	5 Amps (AC)
Output Current	Maximum Current for 3 Relays 110V	5 Amps (AC)
	Maximum Combined Current 3 Relays 24V Dry	1 Amp
Temperature	Min./Max. Operating Temperature	30° - 110° F
Standby Current	Current with all Relays OFF, LED ON	50mA (AC) Typical
	Current with all Relays OFF, LED OFF	30mA (AC) Typical
Sensor Range	pH	4.22 - 9.78
	ORP	0 - 999mV
	Temperature	32 - 212° F
	PPM	0 - 9.99 PPM
	Digital Flow	0 - 9999 GPM
	Volume	0 - 65,535 Gallons
	Flow	Open or Closed

### Input Voltage Selection

The Controller will operate on input voltages of 110 VAC or 220 VAC.

The factory jumper setting is for 110 VAC.

The supply power is commonly used to power the feed pumps and other external loads. If all the loads are 110 VAC then use 110 VAC or if the loads are 220 VAC then use 220 VAC as the input voltage.

#### WARNING

**If the Controller is connected to 220 VAC the voltage selection switch must be changed to 220 VAC before connecting power to the unit or damage will occur.**

Note: It is not possible to power the AK110 Chemical Controller with 110 VAC, and control 220 VAC loads or vice versa.

### Connecting Power

For cord connected installations wait to plug the cord in as the last step in the installation. For hard-wired installations make sure the circuit breaker is off and turn it on as the last step in the installation. Have a licensed electrician perform the installation to ensure the local codes are met.

## Electrical Loads

The Controller with revision F and greater relay board has the capability of utilizing up to three (3) modular relay boards that can be purchased in a number of configurations. The Controller is shipped from the factory with three (3) 110 VAC Normally Open modules installed (Part# 724000050). Listed below are the different types of relay modules that can be purchased and their function. The correct ones must be ordered based on the load requirements. Check with your distributor for the proper relay modules for your application.

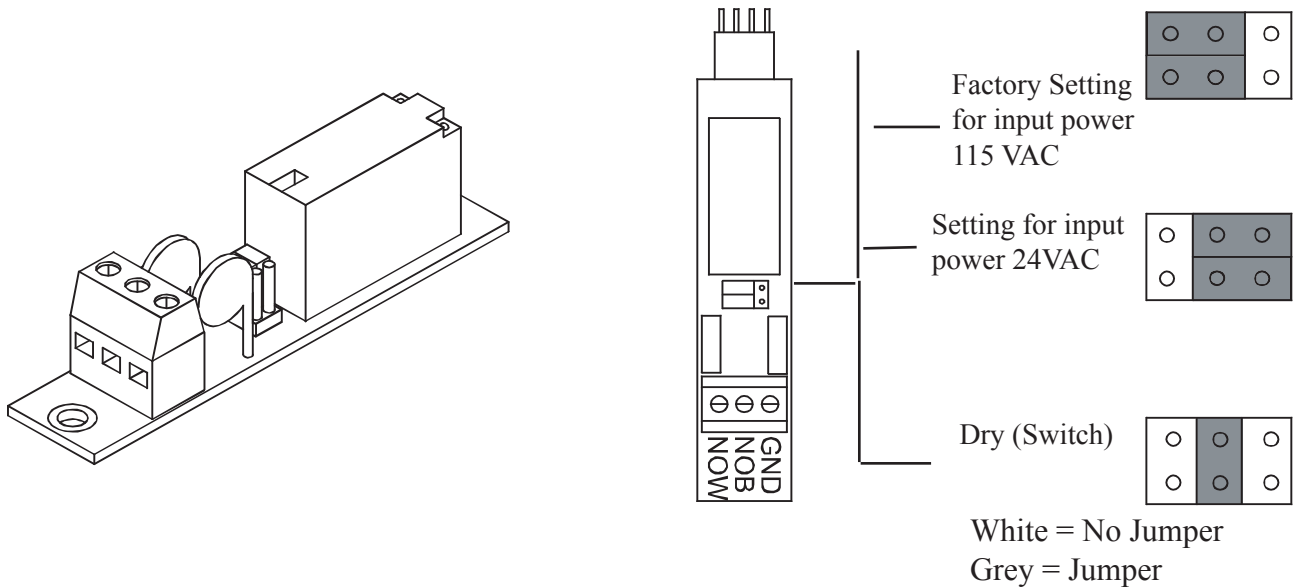

### Relay Modules

Part #	FUNCTION
724000050	For control of 110 VAC Normally Open Circuits (most applications will use this model).
724000060	For control of 110 VAC Normally Closed Circuits.
724000440	For control of 110 VAC Single Pole, Double Throw Circuits, with common white and no ground.

The wiring on each board may be different depending on the model that you purchase. Look on the board, check with your distributor or call Pentair Customer Support at 800-831-7133 with any questions.

### ⚠ WARNING

**Do not change relay modules when power is applied.  
This type of damage is not covered in the warranty.  
Do not connect any load not rated for the supply voltage to any of these relays.**

**TOTAL COMBINED LOADS MUST BE LESS THAN FIVE (5) AMPS  
FOR ALL THREE RELAYS.**

# RELAY BOARD

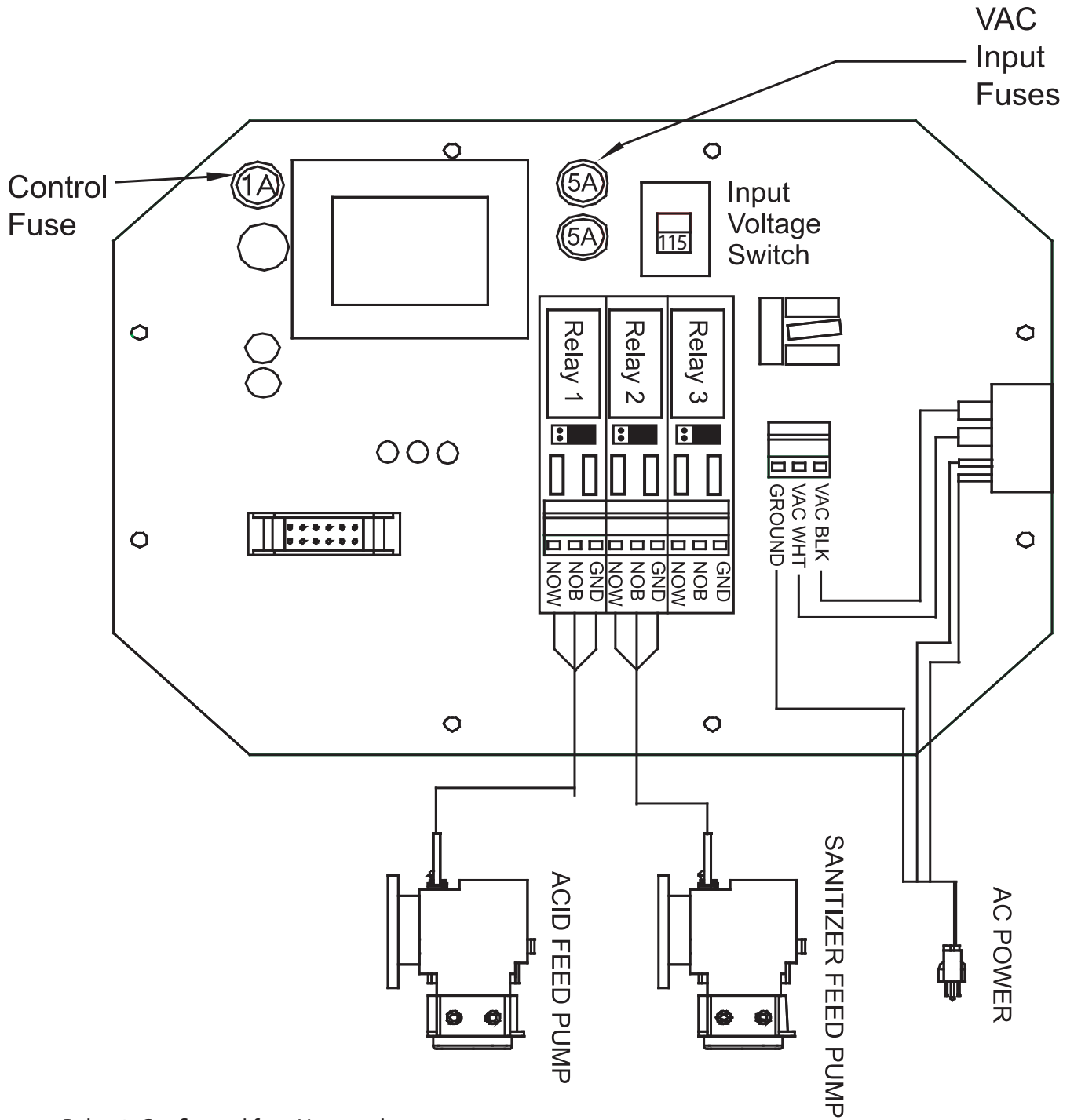

- Relay 1: Configured for pH control.
- Relay 2: Configured for ORP control.
- Relay 3: User configured.

---

## Chemical Feed Pump Location

If unit has not been previously installed, follow the instructions included with the chemical feed pump. Some loads include power cords already connected to the load and are ready to plug in. If "pigtailed" have been ordered with the Controller simply plug the power cord into the appropriate "pigtail". If "pigtailed" are not installed the power cord from the pump will need to be modified. The list below provides installation recommendations:

1. Mount at least 10 feet from open water.
2. Install the pump below the level of the Controller and away from any other equipment or systems. This is to reduce any damage to other equipment should the pump leak.
3. Install close enough to the Controller for the feed pump power cords to reach.
4. If "pigtailed" are included simply plug in the pumps to the appropriate "pigtail". If pigtailed are not installed, cut the electric plugs from the feed pumps and strip and ferrule the ends.
5. Route the power cords to the Controller through the lower fittings and attach to the appropriate relay terminals on the relay circuit board. If the wire ends were stripped and not ferruled make sure that no frays of wire are out of the connector as this may lead to a short.
6. Conduit or external plugs can also be used (according to the codes in the local area).
7. When installing metal conduit into the Controller, a ground LUG should be used to connect the conduit to the relay board ground.

## Heater Installation

The Controller third relay can control a heater, turning it on and off based on the temperature settings you have programmed in to the Controller. The heater control portion of the Controller can be used to maintain a constant temperature or maintain a temperature during operating hours. Even though the Controller is a very accurate and reliable device, for safety, always use the over-temp device on your heater to prevent overheating.

1. Always install any heater according to the manufacturer's instructions.
2. Mount the Controller at least 10 feet from open water.
3. Install close enough to the Controller for the wiring connections to reach.
4. DO NOT attempt to power the heater with the Controller controller.
5. A heater unit must always be independently powered, either through a separate cord, or through an external relay like the Acu-Trol HAR1 relay module. (Part# 735000060)
6. Always use the over-temp device on the heater to prevent overheating.

---

## Plumbing Installation

 **WARNING**

**Be sure to have a licensed plumber perform all plumbing; this is important, as they will be familiar with all of the codes in the local area.**

Follow the instructions that came with the AK1200 flow cell. This section gives the basic principles to be applied for any specific installation, which are listed as follows:

1. Turn OFF all equipment including the filtration system.
2. Determine a suitable location for the flow cell. Which should be located where water spillage will not damage surroundings.
3. Securely mount the flow cell.
4. Install the supply and return lines for each flow cell. Drill and tap  $\frac{1}{4}$ " holes for the  $\frac{1}{2}$ " flexible tubing or hard plumb the flow cell.
  - A. Locate where the water will be supplied from and returned for each flow cell. The most common location for the water inlet to the flow cell is after the main filter and the outlet after the heater.
  - B. If there is no suitable location the cell inlet can be after the main pump and the outlet before the main pump. This method may cause a suction in the flow cell and damage to the sensors. If any chemicals are injected into the cell they may cause temporary invalid readings.
5. Locate the chemical injection points.
6. Prepare and install the chemical injector fittings.
7. Install the chemical storage containers.
8. Install the sensors.
9. Turn ON the main circulation pump.
10. Check for leaks and verify the flow sensor indicates flow.

## Plumbing Installation



### WARNING

Do not inject acid directly in to the AK1200 flow cell.  
Injecting acid in this way may damage the existing pool equipment.

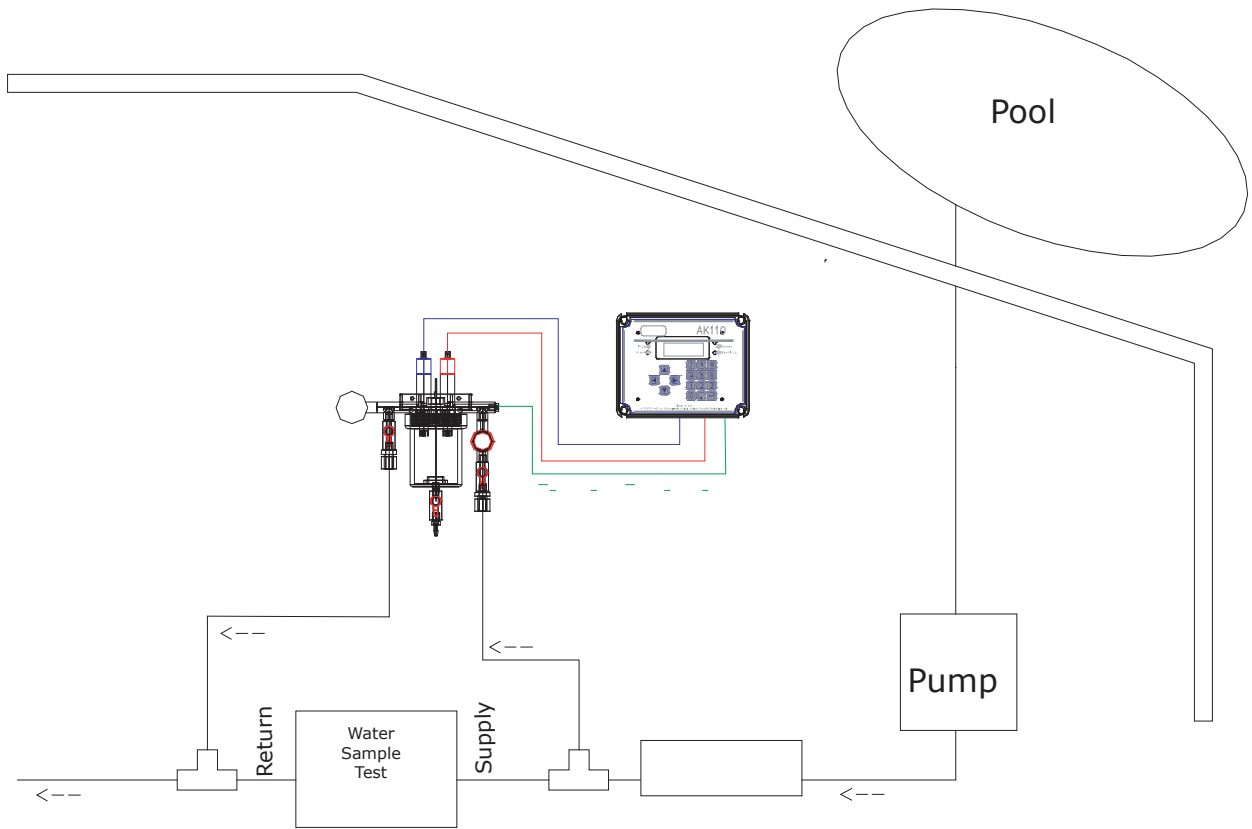

### Preferred Plumbing Routes

---

## **SECTION 3 HARDWARE**

### **Modules**

Modules are the electronic controls and components that make up the Controller.

Each module has a specific function or functions that tell the Controller what information to accept and what information to display. The modular design of the Controller enables it to interface with many types of modules including Sensor, Communication, and Relay modules.

### **Sensor Modules**

Sensor modules determine the types of sensors signals the control can receive. There are three sensor modules currently available for the Controller.

AK111: pH, ORP, temp and heater control. Calculated PPM can also be displayed (Part# 724000010).

AK112: pH, AKColor(PPM), heater control (Part# 724000380)

AK113SC: pH AKColor(PPM) ORP, Temp (Part # 725000390)

### **Communication Modules**

The Controller has the ability to work with several types of communication modules. The Controller can communicate with a PC through an RS232 cable, a standard modem, or a wireless modem.

Controller Modem: High-speed modem. (Part # 725000010)

Wireless Modem: The wireless modem allows the Controller to be accessed over the internet from any PC. Wireless modems are a perfect solution for installations without phone lines. Please note that the wireless modem and the standard modem can not be installed in the same Controller.

### **Relay Modules**

The Controller is able to automate nearly any device in your pump room. The Controller uses a relay module to turn electricity to the device on and off. Each Controller can control up to 3 relay modules. Each relay module can control one device. Relay modules are available in seven different models. The type of relay module used depends on the load requirements of the device that is controlled with the relay module. To determine the load requirements, please consult the instruction manual or the device manufacturer. Any combination of the seven models of relay modules can be installed in the three available slots on a relay board, as long as the combination does not exceed the combined maximum current for the relayboard. The combined maximum current for any individual relay board is 5 amps.



---

The maximum relay current for the relay board is 5 amps when switching 115 VAC or 220 VAC and 1 amp when switching 24 VAC.DRY

**CONTACTS:** These relays act as a dry contact switch only and have no connection to the input VAC. The relay ratings are 5A and 250 VAC.

**115 VAC Normally Closed:** These relays supply the input voltage to the load when the relay is in the “OFF” mode. Note that both VAC inputs are controlled by the relay. The relay ratings are 5A and 250 VAC.

**115 VAC Normally Open:** These relays supply the input voltage to the load when the relay is in the “ON” mode. Note that both VAC inputs are controlled by the relay. The relay ratings are 5A and 250 VAC.

**115 VAC SPDT:** These relays are hard-wired selectable to be either NO (Normally Open) or NC (Normally Closed) switching of the input voltage. They are always powered, and the wiring will dictate whether the power flows in the on or off position. The relay ratings are 5A and 250 VAC. The neutral is common for both NO and NC.

**24 VAC Normally Closed:** These relays supply 24 VAC to the load when the relay is in the “OFF” mode. Note that both VAC inputs are controlled by the relay. The relay ratings are 1A and 250 VAC.

**24 VAC Normally Open:** These relays supply 24 VAC to the load when the relay is in the “ON” mode. Note that both VAC inputs are controlled by the relay. The relay ratings are 1A and 250 VAC.

**24 VAC SPDT:** These relays are hard-wired selectable to be either NO (Normally Open) or NC (Normally Closed) switching of the 24 VAC. They are always powered, and the wiring will dictate whether the power flows in the on or off position. The relay ratings are 1A and 250 VAC. The neutral is common for both NO and NC.

---

## SECTION 4 AK1200 FLOW CELL

### AK1200 Flow Cell

Remove flow cell from shipping carton and make sure all parts are included with AK1200 flow cell.

- 1 – AK1200 Lid
- 1 – Flow switch magnet
- 1 - Sample barb fitting
- 1 - Filter assembly with O-Ring
- 1 - Flow switch with O-Ring, 2' and 10' wire lengths available.
- 2 - Mounting screws
- 1 – AK1200 Jar with O-Ring
- 3 - ¼" Valves.
- 4 - ¼" NPT by ½" flex fittings.
- 2 - ¼" plugs.
- 1 - ¼" Close Nipple
- 1 - Teflon Tape

Note that ½" flexible tubing is not included and is supplied by the installer or may be ordered from Acu-Trol.

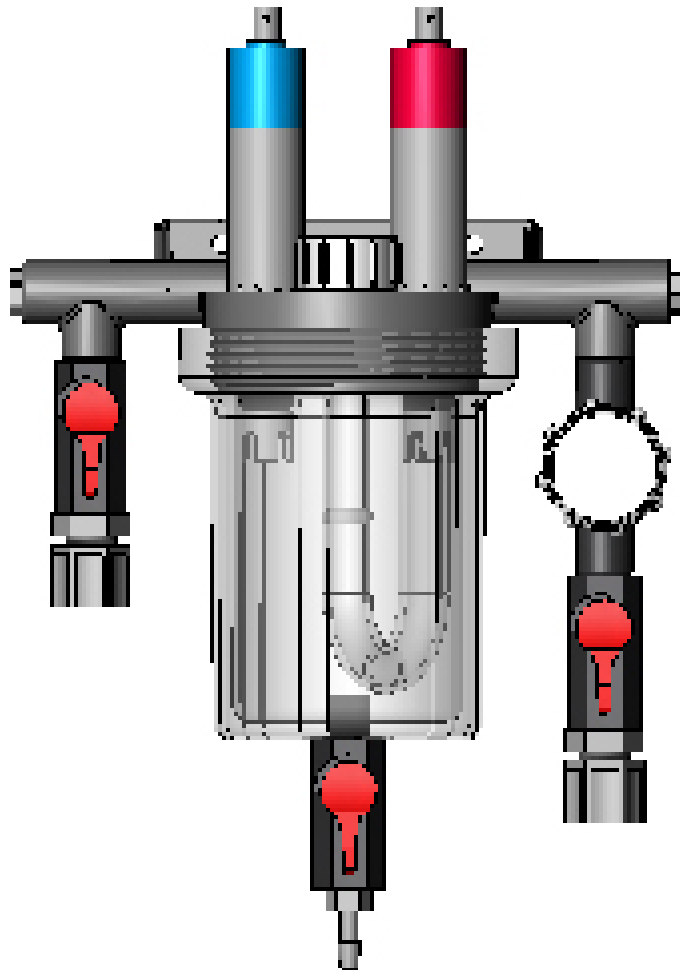

---

## Flow Cell Assembly

1. Wrap all four flex fittings with Teflon tape.
2. Install two flex fittings into two ball valves.
3. Wrap barb fitting with Teflon tape. Install barb into remaining ball valve.
4. Wrap both ends of the close-nipple with Teflon tape. Install into the filter assembly using (either end OK). Hand-tighten only.
5. Install one ball valve into the filter.
6. Install the filter and remaining ball valves as shown in the figure.
7. Verify that the flow switch magnet is in the flow cell tube with the large or hat end pointing down.

NOTE: Wrap fittings only twice around with Teflon tape.

## Flow Cell Mounting

Select a suitable location for the flow cell meeting the following recommendations:

1. Sensors wires will connect to within ten (10) feet.
2. Do not mount in direct sunlight. SUNLIGHT WILL CAUSE INACCURATE READINGS.
3. Water leaks will cause damage! Mount where water does not leak and damage other components.
4. Mount flow cell vertically with provided screws.
5. Securely fasten all electrical, water and chemical lines.
6. Locate chemical feed pumps and chemical storage tanks in a safe and secure area.
7. Maximum operating pressure = 25 psi
8. Extreme pressure variances may affect readings and can cause damage to the sensors.
9. Avoid installing the outlet before the main pump as the vacuum may damage the chemical sensors.
10. Only inject chemicals on the outlet side of the AK1200 Flow Cell
11. Do not over tighten fitting on flow cell top.

## Inlet and Exit Lines

1. It is essential that the supply line be at a higher pressure than the discharge line so the water will flow through the cell at a steady rate in the right direction. Installing a ball valve in the main circulation line may be required if the pressure is too low.
2. Inlet should be installed after filter and before heater.
3. Exit should be installed after heater and as far away from any equipment as possible.
4. Drill and tap at above locations with 7/16" drill and 1/4" NPT tap. Choose a location on a fitting where the pipe enters so you are drilling through both the pipe and fitting to get maximum depth of thread.
5. Install 1/4" NPT by 1/2" flex fittings then route inlet and exit lines.

---

## Sensors

1. pH and ORP sensors must remain wet at all times. Install the sensors into the flow cell, **HAND-TIGHTEN ONLY** and save caps for future use and fill flow cell with water.
2. Route the flow switch wires into the Controller through the strain relief and connect to the Controller. Wire one (either one) to ground and one to the appropriate input switch.
3. Route the chemical sensors into the Controller through the strain relief and connect to the Controller. The sensor wires are labeled and the **PLUS AND MINUS POLARITY MUST BE OBSERVED**.
4. Turn the main pump on and open the valves to test for leaks and the free movement of magnet. Magnet must be all the way up in order to close the flow switch. 1/4 GPM will push the magnet all the way up.

 **CAUTION**

**The flow switch is a dry contact only (no current).  
Use with any other brand Controller VOIDS WARRANTY.**

 **WARNING:**

**Make sure all pumps are OFF before drilling into pipes.  
Never turn chemical feed pumps ON when both  
flow cell valves are closed.**

---

## SECTION 5 SENSORS

The Controller can accept readings from a wide variety of sensors. The sensors the Controller can read depends on the sensor module installed in the Controller. Each sensor has its own unique circuitry that is connected directly to the micro-Controller for measurement. Isolation of each sensor ensures more accurate measurements.

The Controller measures the following sensor measurements with the listed characteristics:

pH - Range: 4.22 to 9.78

ORP - Range: 0 to 999 mV

Temperature - Range: 32 to 212 °F

Flow Switch: This input measures if a switch is open or closed.

### **WARNING**

**Sensors are shipped with a protective cap covering the electrode tip to protect the sensing element. Sensors should be kept in the protective cap until ready for installation, if the sponge in the boot becomes dry, wet it with pool water. Before using the sensor remove the cap.**

### **pH and ORP Sensors**

pH electrodes sense the acidity of the water and work with any acid or base. The blue bands on the cables identify the pH sensors. The red bands on the cables identify ORP sensors. Each sensor is also identified on the sensor body. ORP electrodes are used to monitor the Oxidation Reduction Potential (ORP is sanitization quality of the water) of a given solution. The sensing element of the ORP electrode is made of a precious metal such as platinum or gold.

THE POLARITY (+ AND -) OF THE pH AND ORP SENSORS MUST BE OBSERVED. The ORP sensor (+) copper and the pH sensor (+) copper, and the green leads are (-) polarity labeled. Leave excess wire outside the Controller enclosure. If the cable is longer than needed, it should be coiled neatly and attached under the Controller enclosure.

### **DO NOT CUT THE SENSOR WIRES.**

**Do not stuff excess wire inside the controller as this may cause excess strain on sensor and relay connections.**

---

## Calculated PPM

If you have an ORP sensor module you can choose to operate the AK110 in Calculated PPM (Parts Per Million) mode. When in Calculated PPM mode, the Controller uses a special formula to convert the ORP reading from the sensor in to PPM units. To activate the Calculated PPM mode, select "PPM, Mix Time" or "PPM, Cycle Time" in the wizard section. Note when you are in Calculated PPM mode ORP will not be displayed on any screens. See page 78 for PPM Cycle time menu tree.

## AKColor PPM Sensor

The AKCOLOR is a colorimetric method chlorine analyzer designed to work in conjunction with most Acu-Trol® Controllers. The AKColor is capable of measuring the amount of free chlorine present in a body of water. The colorimetric method of measuring PPM is superior to other methods because it is much less sensitive to varying water conditions, including pH and salinity. The information gathered by the AK Color can be used to control chemical feed pumps and signal alarm conditions. For more information on the AKColor please see Navigation Screen on page 128 or consult your AKCOLOR installation manual.

## Temperature Sensor

The AK10K sensor can be installed to measure/display temperature. The sensor should be installed as close as possible to where the water comes from the pool. If a temperature probe is installed in the AK1200 flow cell there will be a temperature variation due to the long tubes and the temperature in the pump room. A common place to install it is in the small plugged hole in the bottom of the main pump strainer basket.

The sensor uses a special 1/4" NPT fitting to hold the stainless steel sensor. A hole should be drilled (7/16") and tapped (1/4") where the water enters the pump room through a fitting to get double the depth to hold the sensor. If installed outdoors make sure to keep it out of direct sunlight. Route the wires into the Controller through a strain relief and connect to the temperature input. The red wire goes to T and the black wire to GND.

## Flow Sensors

The Controller has the capability of measuring two flow switches in which one or both can be a digital flow sensor. These inputs are general purpose and can measure any dry contact switch state. This can include flow, pressure, temperature, digital flow rate and so on.

The typical uses for the flow switches are:

Switch 1: Typically used to indicate flow through the flow cell and it is OK to feed chemicals. If a digital sensor is used the actual flow rate can be measured and displayed in gallons/liters per hour.

Switch 2: Can be used to measure water level for automatic level control. If a digital sensor is used the actual flow can be measured and displayed in gallons / liters per hour.

### NOTE:

**To obtain liters per minute the scale factor must be changed to pulses per liter.**

---

## Sensor Care

Contamination of the sensing elements often results in slow response and inaccurate readings. Clean the elements by the following procedures:

### pH and ORP Sensors

1. Wash electrode tip in a liquid detergent and water. Carefully use a soft bristled toothbrush to wash the electrode tip and white sensing ring.
  2. Rinse after cleaning. To install, place in flow cell according to the diagram and hand tighten.
  3. Make sure the O-ring is installed on sensor.
  4. If the cable is longer than needed, it should be coiled neatly and attached under the cabinet.
- pH Sensors Only
5. Attempt to clean the sensor with liquid detergent first.
  6. If this is not successful, swirl the tip of the sensor in a 5 parts water and 1 part muriatic acid solution for 10 - 20 seconds.
  7. Rinse again and reinstall.

### WARNING

**Do not rub hard the glass element in the sensor or use sand paper or other polishing material to clean.**

### **HANDLE ELECTRODE CAREFULLY**

**Sensors contain external and internal glass elements. Do not drop or otherwise subject the sensor to vibration, physical impact, or freezing conditions. ANY TYPE OF BREAKAGE IS NOT COVERED UNDER WARRANTY.**

## Finishing and Testing the Installation

Once the Controller system has been installed with applicable sensors and expansion modules the following steps are required for final system finishing and testing.

1. After all wire connections are complete close the panel and tighten the enclosure.
2. Plug in the Controller and turn on the main breaker. Switch the ON/Off switch to ON. Up is ON and down is OFF.
3. Verify that the display is active and displays various introduction/initialization screens.
4. SENSORS: The first screen displays the sensor readings, verify that they are connected properly. Example: pH is within 0.5. This is to verify that the pH is connected to the pH input and the ORP is connected to the ORP input.
5. FLOW: Verify that the flow switch indicates on (S1ON) and the green flow LED is on. Close the valve in the flow cell to stop the flow and verify that the Controller indicates no flow (S1OFF) and the flow LED is off.
6. LOADS: Leave the valve closed (S1OFF) for this part of the test so that the relay programs will keep relays "automatically" off. Press the Right button 1 time to R1 (ph) OFF and press ENTER to "manually" turn on the load, verify that the correct load turns on and press enter to turn it off. Press the down arrow to select the next relay and repeat for the other two relays.

## SECTION 6 OPERATION

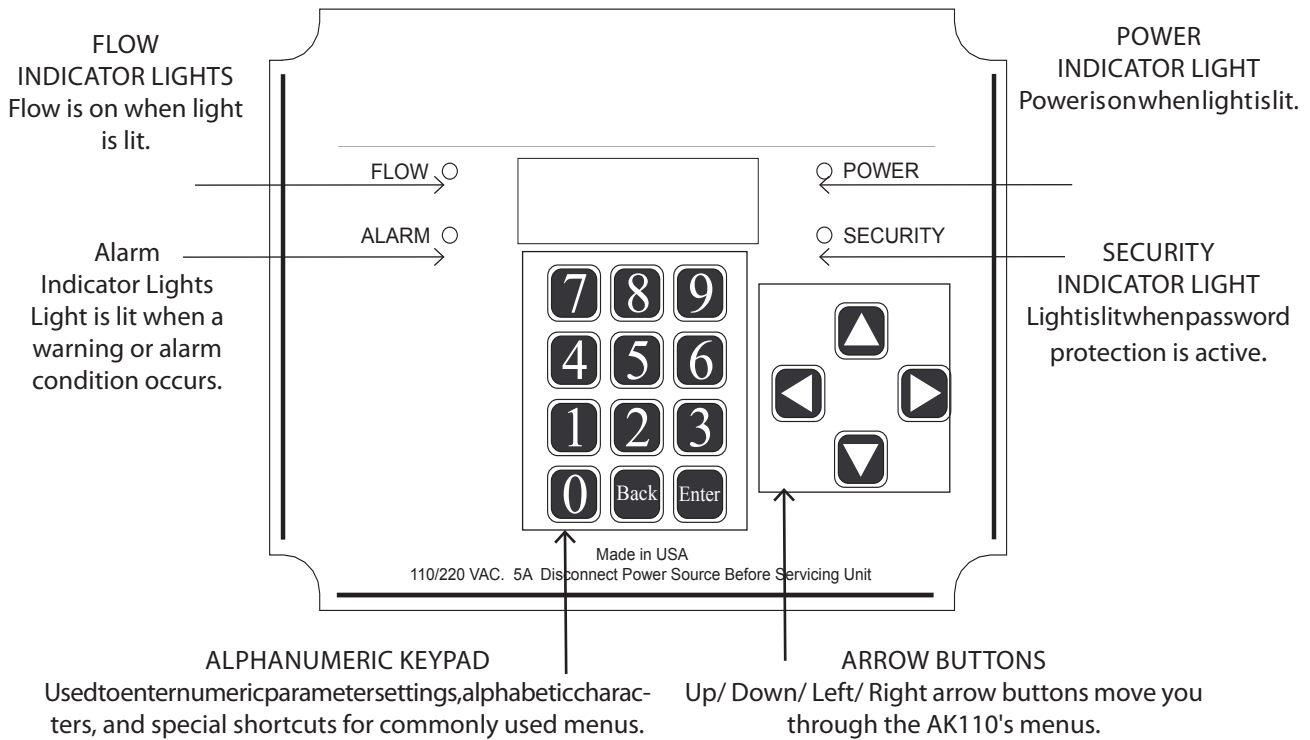

### Configuration Menu Screen

```
>Name:Main Pool
System
Programming
Service
Data ( 8:441 )
Communications
Security Setup
Wizards
Serial # 123456
```

### Main Status, cursor at pH value

```
pH > 7.67-OFF 7.50s
ORP 490 -OFF 700s
69.0f SW1OFFSW2OFF
```

### Window Navigation

This section introduces window navigating and how to edit and modify the Controller settings and programs using guidelines and examples for selecting and changing items.

The Controller provides two main screens for user operations:

1. Display Screen: for monitoring measurements, calibrating and manually turning on relays. This is the list that displays at startup.
2. Menu List: for editing and setup of parameters.



---

## Selecting Items in the Windows

The 16-button touch pad is used to access and modify the different Controller functions:

- Pressing the BACK button on the touch pad will move back one window.
- Pressing the BACK button will toggle between DISPLAY SCREEN and MENU LIST. If the "RED security light" is on a password must be entered to access MENU LIST.
- Pressing the arrow buttons will reposition the cursor on the screen. The UP or DOWN arrow buttons will scroll up or down the screens and the RIGHT and LEFT will move arrows to the RIGHT and LEFT on the screen

See page 48 for more detailed navigation instructions.



### WARNING

**Press 16 Button touch pad with finger pads only. A sharp object such as a pen or tool will damage button pads.**

## MAKING CHANGES

To change a parameter move the cursor to the parameter and press the ENTER key. The Controller will then open the value entry screen for that parameter. The Controller navigation system uses the following considerations:

1. Use the right and left arrows to change to a different digit to enter.
2. Press a number on the keypad to change a digit.
3. Press the left button to add a digit and make the number bigger.
4. Press the ENTER button to save the change.

### NOTE

**Changes must be saved by pressing the final ENTER.  
If ENTER is not pressed as the last step the changes will not be saved.**

## Start Up

The following steps need to be performed to properly setup the Controller:

1. Perform any required calibrations.
2. Decide to use mixing time control or cycle time control.
3. Set up the timing parameters based on the size of the water and chemical feeding system.
4. If the AKRTC (Real Time Clock) module is installed set the time, date and weekday. (Part # 724000280)
5. Set the overfeed time limits in programming.
6. Return as needed to recalibrate any changes to the settings
7. If the AK540 modem (Part# 725000010) is installed, then set the number of rings to answer on and setup the paging conditions.

## Initializing the AK110PS Pool and Spa Chemical Controller

During power-up the Controller will display the Power Up Screens for a few seconds before defaulting to the Display Screen. During this Power On Self Test mode, the Controller will perform a brief check of its internal systems and initialize the internal (RAM) memory for Controller operation. Next the Controller will auto detect for the various installed modules and indicate which ones are detected. The opening screen includes the software version number and will be required when requesting support. When turning on a number will be displayed in the lower left corner of the display screen indicating how many seconds until control will actually start. This is to allow time for the sensor readings to stabilize.

### Power Up Screens

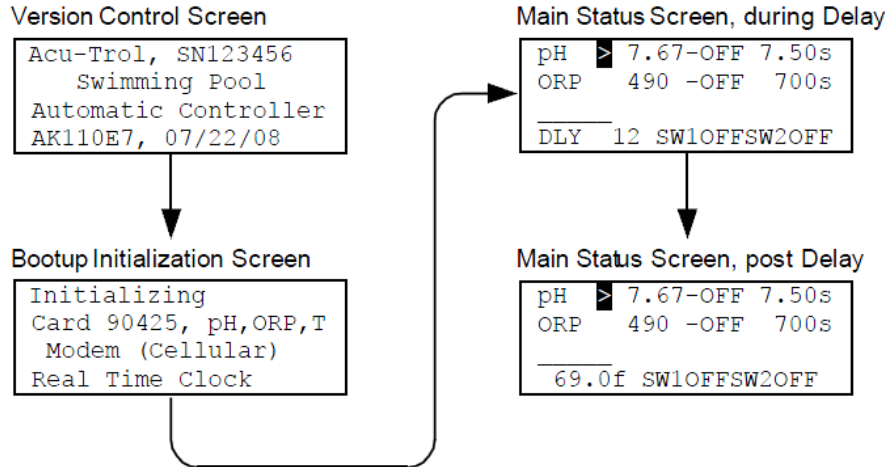

### Display Screen

Display Screen: Displays measurements of connected sensors and also relay status. To the right of the Sensor readings are also displayed the set point values. To change set points you will need to go to programming and change them there. Pressing the Up Arrow key when the cursor is at the top of the readings screen will move you back to the opening screen.

---

## The Display Screen

The DISPLAY SCREEN shows all the current measurements, as well as the user programmed set points. It allows access to specific types of information including the current measurements. Press the arrows on the touch pad to scroll up or down or left or right as indicated by moving the  $\geq$  Cursor on the screen.

Calibration: Position the cursor to the left of any of the three measurements and press ENTER to calibrate that sensor. A value entry screen will then be opened. Enter the calibrated value with the numeric key pad. To save your change and exit the value entry screen, press the enter button. To clear a specific calibration press "0" on the touch pad when the cursor is in front of the value (The reading may not go to a zero reading but it will default to the sensors uncalibrated reading).

### Main Status, cursor at pH Relay

pH	7.67	>	OFF	7.50	s
ORP	490	-	OFF	700	s
<hr/>					
69.0	f	SW1	OFF	SW2	OFF

Manually turn on relays: The relays in the Controller are represented on the display screen next to its corresponding sensor reading. Position the cursor to the left of the status word (either OFF or ON) and press ENTER to toggle the relay on and off. The length of time the relay is on is adjustable in the programming. When the relay is toggled to off the relay immediately goes back to automatic control and in some cases may turn back on immediately.

## Calibrating Temperature

The temperature sensor is very accurate and should not require calibration. If the calibration is more than a couple degrees off there may be an installation problem. The most common problems with temperature sensors are listed below:

1. The most common temperature problem is the temperature is not the same at the sensor as it is in the main body of water. It is also possible the temperature error is different depending on the time of day. Make sure the sensor is not in direct sunlight, and is installed as far into the fitting and as close as possible to the body of water. Evaluate where the sensor is installed.
2. The sensor may be damaged. If the sensor is put in a room of 76°F the resistance should be 10,000 OHM's that can be measured with a standard voltmeter. To calibrate the temperature sensor move the cursor in front of the temperature reading and press ENTER. Enter the measured value. Press ENTER again to save the calibration change.

## Calibrating pH

Measure the pH using a standard test kit by taking several readings and averaging the results. To calibrate the pH sensor move the cursor to pH and press ENTER. Enter the value obtained from the test kit in to the value entry screen. Press ENTER again to save your changes.

## Calibrating ORP

### **WARNING**

Always make sure the pH is at the set point before calibrating ORP. Always control at PPM levels greater than 1.0 PPM when using ORP sensors.

### **IMPORTANT:**

For best results the ORP should be at the ORP set point when calibrating.  
For best results the PPM should be at the desired level when calibrating ORP.

Measure the current PPM using a standard test kit. Calibrating ORP is intuitive and takes a little practice. The following table can be used to improve the accuracy of the calibration. Follow the recommendations in the table and within a few days the PPM should be on track. The values of interest are:

Measured PPM: The hand measurement.

Desired PPM: The actual PPM that is desired in the pool.

ORP: The value of ORP that is displayed on the screen.

ORP Set point: The value of ORP that the Controller is trying to achieve.

Hand PPM	ORP Display	Action
Low	Above hand check	Calibrate to hand check measurement: 10mV per each PPM Low
	At hand check	Review Setpoints: May need to increase chemical feed times
	Below hand check	Calibrate to hand check measurement: 10mV per each PPM Low
Perfect	Above hand check	May need to decrease chemical feed times & calibrate to hand check
	At hand check	No changes
	Below hand check	Calibrate to the hand check
High	Above hand check	May need to decrease chemical feed times & calibrate to hand check
	At hand check	Lower the set point
	Below hand check	Calibrate to hand check measurement: 10mV per each PPM High

## Calibrating ORP

EXAMPLE 1: The default set point is 700, the PPM hand measurement is 1.0 (2.0 PPM desired), and the current display shows a measurement of 690 mV. From the above table the hand PPM is low and the ORP is below the set point. The chemical feed times are not high enough for the ORP to reach the set point and should be increased.

EXAMPLE 2: From example 1 change the hand measurement to 4.0 PPM with ORP reading 700mV. From the above table the hand PPM is high and the ORP is below the set point. The ORP should be calibrated to  $700 + (4.0 - 2.0) * 10 = 720$ . To compare ORP measurements to PPM measurements per actual pH readings refer to

## Calibrating Calculated PPM

If you have an ORP sensor module and Calculated PPM mode selected. You can calibrate the Calculated PPM in the following manner. Measure the PPM using a standard test kit. To calibrate the PPM, move the cursor to PPM and press ENTER. Enter the value obtained from the test kit in the value entry screen. Press ENTER again to save your changes.

### NOTE

**You can enter the password 9003 to see the ORP and adjusted ORP being used for calculated PPM. These ORP values will only be displayed for four (4) seconds.**



### WARNING

**Always make sure the pH is at the pH setpoint and PPM is greater than 1.5 PPM before calibrating calculated PPM.  
Always control at PPM levels greater than 1.0 PPM when using ORP sensors.**

## MANUAL RELAY CONTROL

### Display Screens

Position the cursor to the left of the status word and press ENTER to toggle the relay on and off. The length of time the relay stays on is adjustable in the programming. When the relay is toggled to OFF the relay immediately goes back to automatic control and in some cases may immediately turn back ON.

### Main Status, cursor at pH Relay

```
pH 7.67>OFF 7.50s  
ORP 490 -OFF 700s  
-----  
69.0f SW1OFFSW2OFF
```

## RELAY TIMER DISPLAY

The Relay Timer display indicates the present status of the 8 timers used in the Controller. The most common use for this screen is to perform diagnostics on a specific relay or to see how long a relay has been on. From the DISPLAY SCREEN press the right arrow button twice. Press the left arrow button to return to readings screen.

### Timer Screen, Relay 1 (pH)

```
pH, Mix TMR00:00:00
          >TD00:00:00
CNT:    0 S 00:00:00
STS:OFF TOT 0:00
```

Note: To reset the relay timers to zero use the right button to scroll the cursor beside the information that you want to reset and then press the ENTER button.

- TMR: Displays relay timer. Shows time remaining for relay on time. This timer will be counting with off and on cycles. Counting down when ON cycle, counting up when OFF cycle.
- TD: Displays the time the MPS has been ON for the current day (ToDay).
- CNT: Total number of relay cycles since last reset.
- S: Set overfeed timer, length of relay on time without reaching set point.
- STS: Status of relay ON, OFF, Set Point Overfeed(SOV), Overfeed(OVF), and Disable (DIS).
- TOT: Displays the total time the MPS has been ON since last reset in hours:minutes.

## SETUP FLOW

To use a switch as a digital flow switch you must first set it up. To enter the setup screen from the DISPLAY SCREEN move the cursor to the switch "SW\_" to be setup and press ENTER. You can enter the number of pulses per gallon from 1 to 999.9. This second method should only be used for flow meters that generate less than one pulse per gallon. The highest volume that can be accumulated from the flow rate is 65,535 gallons. Flow can also be displayed in g/pul and Piezo.

NOTE: Switch 1 is the default flow switch for relay control and should not be used for digital flow if switch 2 is available.

### Flow Switch 2 Setup

```
Flow Switch #2
SW2 K => 8.5 pul/g
g/m   = 35
Total = 256 Clear
```

**NOTE: If k = 0 than g/m = and Total = will not be displayed on the screen.**

To clear the Total, for any switch place the cursor on Clear and press ENTER.

## Flow Switch 2 Setup, Clear Counter

```
Flow Switch #2
SW2 K => 8.5 pul/g
g/m   = 35
Total = 0    >Clear
```

**Note:**  
**When entering pulses per gallon the Controller will only update this measurement once every 10 seconds.**

## Configuration Menu

The Configuration Menu consists of the following:

- **Name:** Sets up the name of your aquatic system for easy identification during communication and on the wireless data management system. See pages 56 for Controller Name Navigation Menu Tree.
- **System:** Sets up time, date, weekday, and unit display (English or Metric). See pages 58 or System Set-up Screen Navigation.
- **Programming:** Relay programming for Relays 1, 2, 3, Alarm, and Pagers. See Programming Section for details. See pages 52-109 for Programming Set-up Menus.
- **Service:** Clear calibrations, data, or relay timers as part of normal service operations.
- **Data:** Sensor readings are recorded at a default 2 hours into data. A total of 441 lines of data can be stored. Press the down arrow key to view data. See page 114 for Data Screen Navigation.
- **Communications:** Set up modems, pager numbers and or email addresses. See pages 102-105 for Programming Screen Navigation **Pager 1.** See page 116 for Communications Screen for Dial-up and Internet Modems. See pages 106 for Programming Screen Navigation Email.
- **Security Setup:** Sets up passwords, clears passwords, and resets all settings to factory defaults. See pages 126 for Security Setup Screen Navigations.
- **Wizards:** Select pre-written programs for common Controller applications. See pages 110 for Wizards Setup Screen Navigation.
- **Serial #:** View the serial number here. The serial number is required when requesting support.

### Configuration Menu Screen

```
>Name:Main Pool
System
Programming
Service
Data ( 8:441 )
Communications
Security Setup
Wizards
Serial # 123456
```

---

## Name

The Name Setup submenu allows the system controlled by the Controller to be specifically identified on the Controller and in its communication with other devices. The name of the Controller is particularly useful when using remote communication devices such as the standard and wireless modem. Naming each aquatic system, pool, or spa will make it easier to identify each Controller and verify its location before making modifications to the system.

The alphanumeric characters that make up the system name are entered using the touch-pad. You have a full range of letters, numbers and symbols available to aid you in uniquely identifying each system under your control.

## System

Opens a menu where time, date and day can be changed.

- Time: Time of day; place cursor next to TIME select ENTER to set time in hours, minutes, seconds.
- Date: Optional with Real Time Clock Module. (Part# 724000280)  
Date must be set when Real Time Clock is installed. If not installed date with default to 00:00:00.
- Day: Optional with Real Time Clock Module. Day must be set when Real Time Clock is installed.  
If not installed day with default to 00:00:00.
- Units: Select to toggle between Metric and English units. When metric is selected the date is dd/mm/yy, when English is selected the date format is mm/dd/yy.
- Sanitizer: Select between "Cl" (chlorine) and "Br" (bromine).
- On Delay: Pressing Enter on this line increments (by 15) the number of seconds the relays will be off on power up.
- Backlight Time: Select the amount of time the Controller screen backlight will be on each time the control panel is activated.
- Temp Display: Displays water temperature in Fahrenheit degrees. Turn temperature sensor off, toggle on/off and select enter.
- Reset to Default: Returns Controller to original factory default settings.



---

## Programming

The Programming menu provides sub-menus used to configure and view the three output relays, alarm, and 4 pagers as appropriate. To edit a program use the up and down arrows to position cursor and press ENTER.

Below are the edit option screens for pH. Use the up and down arrow to position the cursor in front of the option to be edited.

**Edit Settings:** Place the cursor to the desired location to edit the values. Setting a value equal to zero will disable that command. For example, the Off if Sw Off command is disabled in the program below. To enable this command change the "No" to "Yes".

**Manual Time:** The amount of time the relay will turn on during a manual cycle. This will occur each time the manual cycle is activated.

**Proportional:** The percentage of the set point where the Controller will begin automatically shortening the length of the feed cycle to prevent the Controller from over shooting the set point. To turn off the proportional feed function, enter "0" as the proportional feed percentage.

**Example:** 5 is entered as the proportional feed %. This means that the Controller will automatically shorten the length of the feed cycle once the measured reading is within 5% of the set point. If the pH set point is set at 7.50, the proportional feed will begin to limit the feed cycle at 7.87 and continue to shorten the feed cycle each time it feeds until set point is reached. For best results, the proportional feed percentage should be kept between 0 and 5 percent.

### Programming Setup Screen

```
>>1:pH, Mix Time
2:ORP, Mix Time
3:Not Used
A:Alarm
P:Pager1
P:Pager2
P:Pager3
P:Pager4
```

### pH Mix Time Programming Screen

```
ManualTime 00:02:00<
Proportional% 10
On If pH> 7.50
On If pH< 0.00
Off if RLY On 2
On DELAY 00:00:20
On Time 00:01:00
MinTimeOff 00:05:00
Off if Sw1 Off-YES
Off if Sw2 On -NO
SetOvrfeed 00:00:00
Overfeed 01:00:00
```

---

## Programming

On If pH>: Acid Feed: the set point value at which the Controller will begin to feed acid or other pH chemicals to the water source. Set this value to zero if not using acid to control the pH.

On If pH<: Base Feed: the set point value at which the Controller will begin to feed base or other pH chemicals to the water source. Set this value to zero if not using base to control the pH.

Off if RLy on(#): Number of relay (1 or 2) will display. Depending on which relay is on the other relay will remain off. Prevents both relays from coming on at the same time and mixing Chlorine and Muriatic Acid.

On Delay: This is a built in timer which prevents the Controller from prematurely mixing chemicals still in the system or when suction side chemical feeding is used. This prevents the relay from turning on while chemicals are mixing in the system.

On Time: Maximum amount of time that the Controller will dispense chemicals.

Min Time Off: Minimum amount of time that the Controller will be off before it will dispense any more chemicals, regardless of the set point reading.

Off if Sw\_Off: Tells the Controller not to dispense any chemicals if this switch number is in an OFF condition. This prevents a large amount of chemicals from being added into the water line as flow of water returns.

Set Point Overfeed: If a relay output is "ON" accumulative for longer than the set point overfeed's maximum time allowed the reading screen will display a "SOV" (Set Point Overfeed) on relay display. (This is to keep the Controller from continuously feeding chemicals in case the sensor has a problem or if there is a clog in the feed tubes or you run out of chemicals). This control condition will automatically reset itself if the sensors set point value is reached.

Overfeed: This value should be set for the maximum accumulated "ON" time that the Controller will be allowed to feed each chemical in a 24 hour period. If the Controller's "ON" time exceeds the total allowed "ON" time within a 24-hour period the Controller will disable the associated feed relay, and not feed any more of that chemical until the overfeed timers are cleared manually, or until the Controller automatically resets the overfeed timers at the end of its 24 hour day. Each relay output used to control a feed system will have its own overfeed settings. Exceeding the overfeed timers can be set to cause an alarm condition. If the overfeed time alarm condition persists over a few days you may need to check the chemical container levels, Controller feeder problems or you may need to increase the overfeed time to a level that will allow the Controller to maintain the water quality levels within your specified limits. If the system does go into an overfeed condition along with the alarm LED coming on, it will also display an "OVR" statement in the display screen, for the relay output that was in an overfeed condition. Overfeed for 01:15:00 or 01:30:00, in case there was a problem with the feeder, chemicals or the sensor that are in overfeed condition, the Controller would disable feed and alert a problem.

NOTE: The Controller's Overfeed feature is equivalent to the amount of time the chemical feeders will feed during an alarm condition.

### OPR Indicating Overfeed Condition

```
pH 7.67>OFF 7.50s
ORP 490 -OVR 700s
69.0f SW1OFFSW2OFF
```

### Timer Screen, Clear Overfeed

```
ORP, Mix TMR00:00:00
          >TD01:30:00
CNT: 0 S 00:00:00
STS:OVR TOT 0:00
```

---

## Programming

**To manually reset the Overfeed Timer be sure that the cursor is beside the TD Reading and press the ENTER button. This will reset the timer to zero.**

## Service

All Off 10 min (NO) Press the Enter button to turn all three relays off for 10 minutes. This feature is useful when calibrating. After selecting the display will change to (YES) selecting the line again will remove the "All OFF" condition.

- Clear Calibrations: Clears all previously entered calibrations
- Clear Data: Erases all of the existing data.
- Clear Relay Timers: Resets all timers to zero for all relays.

## Data

Sensor readings are recorded every 2 hours into the data log. Up to 12 lines of data can be recorded a day. The Controller will save up to 441 lines of data in its data log. When the data log is full the oldest records will be overwritten.

The default data log includes the day of operation, the hour sequence, and the sensor readings. When used in conjunction with a real time clock, data includes date and hour and sensor readings. Pressing the down arrow key to view subsequence data.

When downloading the data with a PC the following information will also be displayed:

Title = MPBPF123: Modem, PC RS232, Front Button pressed, Password entered, Flow S1 on, and relays 1-3 status.

---

## Communications

The followings are only available if the modem is purchased and installed.

**Modem:** Sets up the number of rings to answer on and the long hang up time. If you enter the password 9000 you can access the modem diagnostic screen. On the modem diagnostic screen you will see the modem initialization string that was returned by the modem during startup. This string should end with the word "OK" for working modems.

**Pager Test:** Tests pagers and displays paging status. To test the pagers, simply Press ENTER while in this screen. The screen displays which pager is being paged and its counting down time. If the paged modem (pager company) is not answering, the Controller modem will hang up within 40 seconds, and the modem is reset, ready for the next page. You can press the BACK button at any time to cancel the testing process.

### Pager Setup Screens

**Pager Numbers:** Sets up the pager numbers. The programming setup screen will display up to four pager numbers. This will allow the system to page up to four numbers to alert more than one technician when a pool problem arises.

The process to enter pager numbers in the AK110 is as follows:

1. Press BACK button to reach MAIN Screen.
2. Scroll down to Communications
3. Press ENTER to select Communications
4. Scroll down to pager numbers and press ENTER to select pager numbers
5. Select the #1 pager number location.
6. Using the key pad to enter pager number. Using cursor arrows to move to the next number and so on. (The key pad works exactly like a cell phone key pad and entering information as you would a phone number in your cell phone address book). See AK110 Programming Screen Navigation on page 88 for details on alarms. Make sure to enter the "comma" to allow enough delay time for the modem on the other end to pick up. Each comma is worth 4 seconds of time. Use the 0 button to toggle the ',', '-', and '#' for pager editing. Press ENTER to save the changes. Here is an example for a pager number entry: 18005552222,,9014910,,911#. The actual pager number is your phone number. You determine a code (example: 911 for chemical overfeed) depending on what you want the pager to define as a problem. The string always ends with a '#' sign. If a mistake is made press UP to delete. Press DOWN to abort entry. See AK110 Programming Screen Navigation, Pager 1 and 2 for details on page 102.

#### Pager Numbers Screen

```
1:12125552368,,1234
56,,11#
>2:12125552368,,1234
56,,12#
3:12125552368,,1234
56,,99#
4:
```

Enter

#### Pager String Setup Screen

```
1
12125552368,,123456,
,12#          U
v-Cancel  Back-Ins
```

---

## Email Set-up

Email addresses:

The programming setup screen will display up to four email addresses. This will allow the system to email up to four addresses to alert more than one technician when a pool problem arises. The process to enter email address in the AK110 is as follows:

1. Press BACK button to reach MAIN Screen.
2. Scroll down to Communications
3. Press ENTER to select Communications
4. Scroll down to Email addresses and press ENTER to select Email addresses
5. Select the #1 email address location.
6. Using the key pad to enter email address. Using cursor arrows to move to the next letter and so on. (The key pad works exactly like a cell phone key pad and entering information as you would a phone number in your cell phone address book). If your email address is too long for the spaces available use the next available email address to complete the address. Add "+02" to the end of the address where you need to break to the next line.

Example: email 1: johndoe@+02  
email 2: myserver.com

Example: email 1: johndoe@+02

email 2: myserver.com

See page 106 for more detailed email set-up process.

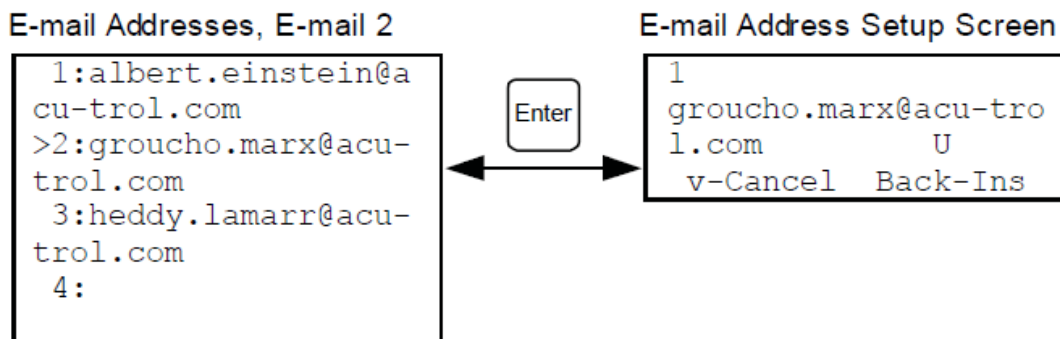

## Security

Up to two levels of security may be implemented on the AK110 Controller.

1. Master Password: The master password enables access to all controller functions and menus. A master password may be implemented alone or in conjunction with a service password.

2. Service Password: The more limited Service password allows access to sensor calibrations screens from the Main Status Screen. A service password may be implemented only after a master password has been implemented. Passwords consist of up to nine digits.

Password restrictions:

1. The password may not begin with a zero (0) as the first digit.
2. The security password must be in the range of "1" and "8999" and "9011" and "99999999". The numbers 9000-9010 are reserved for technical support purposes and may not be used.
3. A master password is required for should a wireless modem be installed in the AK110.

See page 126 for the AK110 Security Set-up Screen Navigation for more detailed security set-up process.

---

## Wizards

When leaving an editing screen you will need to confirm the changes by pressing "9" or cancel by pressing press "7". Also after making any changes be sure to press the "Back" button until you reach the main menu screen. Otherwise your changes will not be saved.

The following list shows all the "Wizards" available with the Controller:

### Control options for pH Relay 1

1. pH, Mix Time – use to control a pH feed system.
2. pH, Cycle Time – use to control a pH feed system.
3. Not Used – use to disable this relay

### Control options for ORP/PPM Relay 2

1. ORP/PPM, Mix Time – use to control a sanitizer feed system.
2. ORP/PPM, Cycle Time – use to control a sanitizer feed system.
3. ORP, Cal Hypo - use to control Cal Hypo feed system
4. Not Used - select to disable this relay.
5. PPM, Mix time - use the calculated PPM features
6. PPM, Cycle time, use the calculated PPM features

### Control options for Relay 3

1. Not Used - select to disable this relay.
2. Probe Clean - use to introduce acid for a short time to clean sensors.
3. Heater - Used to control temperature with an external heater.
4. Alarm Out - external alarm control.
5. pH, Mix Time - used for additional pH control (i.e. when both Acid and Base are needed).
6. pH, Cycle Time - optional method see program.
7. AUX: Make UP - control a make-up water system (auto fill).
8. Daily - turns on relay once per day
9. Weekly - turns on relay once per day on selected day(s) of the week.
10. ORP/PPM Mix Time - use for additional sanitizer control (i.e. when a liquid feed system is used to back up a salt generator).
11. ORP/PPM, Cycle Time - optional method see program.

### Control options for Pager/Email 1-4

1. Pager 1-4/Email 1-4
2. Not Used

See page 110 for the AK110 Wizards Setup Screen Navigation

---

## SECTION 7 TROUBLESHOOTING

### COMMON PROBLEMS

PART	PROBLEM	SOLUTION #1	SOLUTION #2
Alarm	High pH alarm on	Increase ON time (CO2) = slower reaction, needs more time ON.	Check chemical tank and make sure it is not empty.
Flow Cell	Magnet will not go up	Clean filter on flow cell.	Back wash main filter or increase flow.
ORP/pH Probe	Readings bounce	Clean probe, check ground on input power.	Reduce flow through flow cell.
Flow Switch	Not working	Check for magnet.	Check for debris in flow cell.
Alarm	Overfeed alarm on	Increase overfeed time.	Make sure feeder is working properly.
Program	Relay 1 & 2 not turning ON but work manually	Make sure flow switch is closed. Verfiy that the green flow light is turned on.	Check set points.

### The Real Time Clock

The Real Time Clock (RTC) is an optional module (PN# 724000280) that allows time display and time stamps in the data log. The Controller will automatically detect the real time clock when it is installed. The real time clock is battery powered, with a minimum of 5 years battery life.

## ORP Troubleshooting

ORP Calibration Actions		
Hand PPM	ORP Display	Action
Low	Above Set point	Cal to below set point: 10mV per each PPM
	At Set point	Check flow and/or clean sensor.
	Below Set point	Cal to below set point: 10mV per each PPM May need to increase chemical feed times.
Perfect	Above Set point > 6	May need to decrease chemical feed times.
	At Set point $\pm 5$	Calibrate to the set point.
	Below Set point >6	No changes Calibrate to the set point.
High	Above Set point	Decrease chemical feed times.
	At Set point	Cal to above set point: 10mV per each PPM
	Below Set point	Cal to above set point: 10mV per each PPM Check flow and/or clean sensor.

EXAMPLE: The default set point is 700, the PPM hand measurement is 1.0 (2.0 PPM desired), and the current display shows a measurement of 690 mV. From the above table the hand PPM is low and the ORP is below the set point. The chemical feed times are not high enough for the ORP to reach the set point and should be increased.

To compare ORP measurements to PPM measurements per actual pH readings refer to the calculated PPM chart on page 131.

### Using the Test Strip

1. Remove all wires from the sensor card.
2. Insert test strip into the green terminal bar on the sensor card.  
Match the pH test strip side to the sensor card side
3. Reset the calibrations with the test strip installed.
4. Call Acu-Trol Technical Support at 800-273-4667 with the sensor readings if your results do not match the following readings:

ORP 90350-28ApH = 7.65-7.75    ORP = 485-500    Temp = 68.0-71.0  
 PPM 90350-35ApH = 7.65-7.75    Color = TBD    Temp = 68.0-71.0



## AKColor PPM Troubleshooting

Problem	Solution
PPM Reading is 0 or 9.99	<ol style="list-style-type: none"> <li>1. Check Flow to AKColor Flow Chamber</li> <li>2. Check Chemical Levels</li> <li>3. Check Discharge from DPD and Buffer Solenoids</li> <li>4. Clear Calibrations</li> </ol>
Chemical Reagents are being quickly	<ol style="list-style-type: none"> <li>1. Check sample rate, decrease to 5 min or greater. used too</li> <li>2. Check the DPD and Buffer solenoids for leaks</li> </ol>
Measured PPM Level is lower than the hand check reading	<ol style="list-style-type: none"> <li>1. Check sample flow solenoid for leaks</li> <li>2. Recalibrate the PPM reading with pH at setpoint.</li> </ol>
The clear voltage is not 3.5	<ol style="list-style-type: none"> <li>1. Adjust the potentiometer in the AKColor</li> </ol>

## pH Troubleshooting

Problem	Solution
pH not reading correctly	<ol style="list-style-type: none"> <li>1. Use the test strip to verify pH</li> <li>2. Confirm that the BNC sensor wires are installed correctly</li> <li>3. Install a new BNC sensor wire.</li> <li>4. Check the manufacture date of the sensor</li> <li>5. Confirm that the flow rate in the AK1200 Flow Cell is between 0.5 and 1.5 liters per minute.</li> </ol>
pH readings response slow to changes in the water	<ol style="list-style-type: none"> <li>1. Confirm that there is flow in the Flow Cell</li> <li>2. Clean the pH sensor using the Acu-Trol pH sensor or cleaning procedure listed in this manual.</li> </ol>
pH readings inaccurate	<ol style="list-style-type: none"> <li>1. Recalibrate the pH reading</li> </ol>

---

## SECTION 8 APPENDIXES

### Utility Passwords 9000-9010

From the Main Status screen press [4] to enter the password screen.

- 9001 – Enter once for 1-second data recording rate. Enter a second time for 5-minute data recording rate. To go back to the default 2-hour recording sample rate, power the unit off and then back on.
- 9003 – When in “Calculated PPM” mode, shows the actual ORP and the adjusted ORP derived from Calculated PPM calibrations.

### Set Up Digital Flow

To use Switch 1 or Switch 2 as a digital flow switch you must first set it up in the flow switch set-up screen. To enter the setup screen from the MAIN SCREEN, move the cursor to the switch “S” to be setup and press ENTER. Enter the number of pulses per gallon from 0 to 999.9. NOTE: Switch 1 is the default flow switch for relay control and should not be used for digital flow if switch 2 is available.

To clear the total accumulate flow counter, place the cursor to CLEAR and press ENTER.

### Proportional Feed

The proportional feed value determines the ratio of feed ON time in a cycle. The general principle is that a relay should be on for a reduced amount of time as it nears set point so as to minimize chemical feed overshoot. A lag time exists between the time the chemical feeds and the sensors "read" the new values. Older Controllers would have a relay on continuously which can lead to significant overshooting of the chemical feed. The Controller adjust the ratio based on how far from the set point is from the measurement. The following tables shows examples of feed times for various conditions:

Set Point	Measurement	Prop %	Actual On	Actual Off	Cycle
700	630	10%	00:06:00	00:00:00	00:06:00
700	631	10%	00:05:54	00:00:06	00:06:00
700	698	10%	00:00:06	00:05:54	00:06:00
700	665	10%	00:03:00	00:03:00	00:06:00
700	100	10%	00:05:06	00:00:54	00:06:00
700	699	10%	00:06:00	00:00:00	00:06:00

Table 3. ORP Control with the Cycle Time control type.  
Cycle time = 6 minutes

# SECTION 9 WIRING DIAGRAMS Relay Wiring Diagram

Back View of the Switch

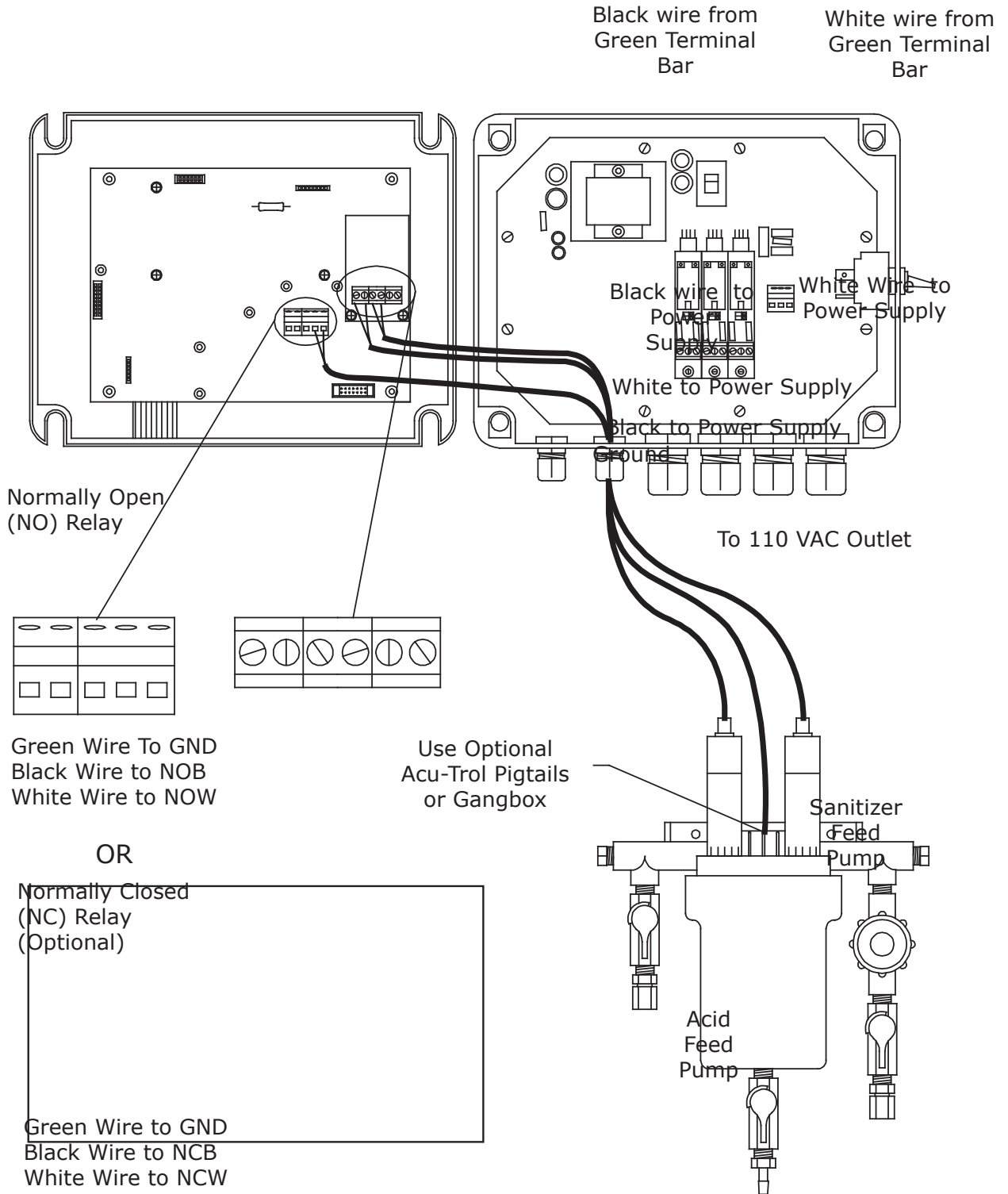

# Sensor Wiring Diagram

AK110PS Chemical Controller Top View AK110PS Chemical Controller Bottom View

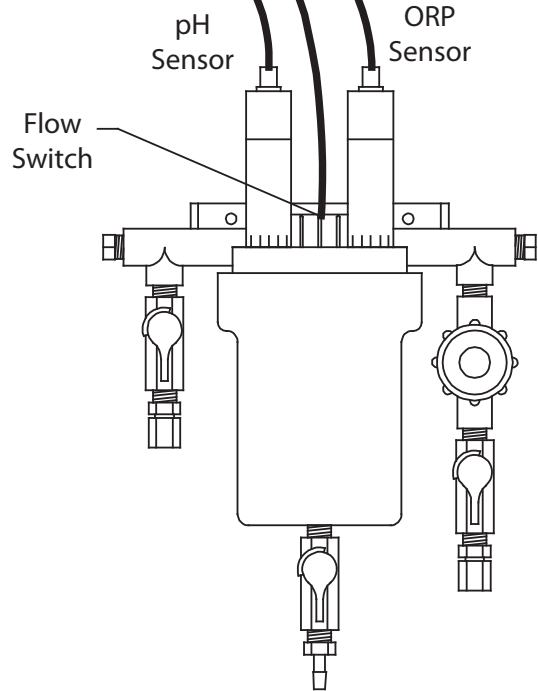
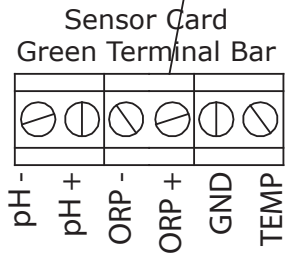
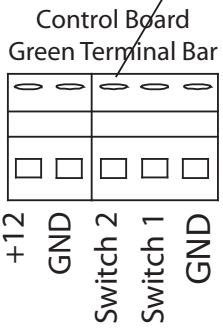
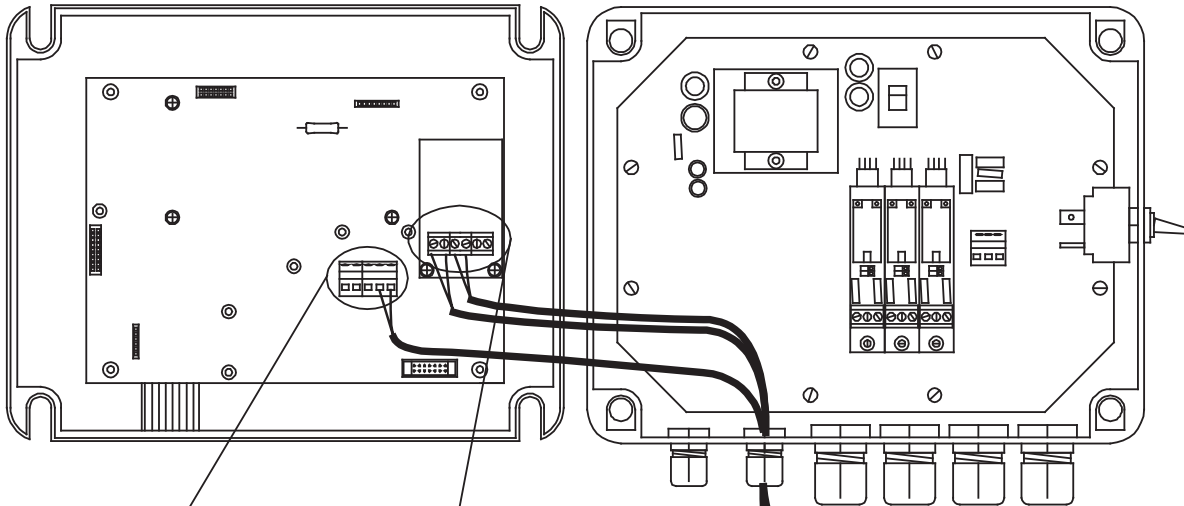

pH Sensor Wires  
= Green to pH -  
= Copper to pH +

ORP Sensor Wires  
= Green to ORP -  
= Copper to ORP +

Flow Switch Wires  
= Red to GND  
= Black to Switch 1

## SECTION 10 MENUS

### SCREEN NAVIGATION KEYS

For basic Controller operations, follow the screen navigation keys. The arrows guide you to each level and provide you examples of the information based on the condition of your pool. The actual information on the Controller screen will differ from the menu examples. The LCD back-light turns off following a user-defined period of inactivity. Press any key to turn the on back-light. The LCD screen displays 4 horizontal rows at a time. Many menus consist of five or more lines.

Use the up or down arrow keys to navigate through longer menus to display additional menu options on-screen.

PLEASE CALL 800-831-7133 FOR TECHNICAL ASSISTANCE.

#### NOTE:

The keypads on the mounted AK110 Chemical Controller do not have the letter of the alphabet or numbers printed on the keypad.  
The some models curser keys do not have "Delete", "To Right", "Cancel" or "To Left" printed on the keys.

#### Using the AK110 Keypad to Name the Controller

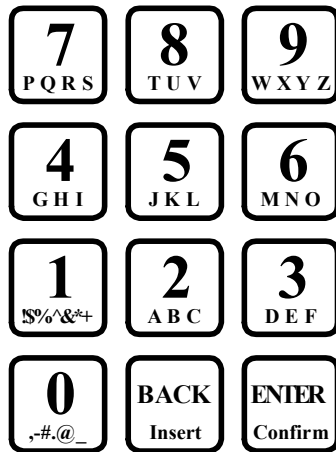

Each numeric key is associated with three or more letters of the alphabet, or with punctuation and other special characters.

Successive keypresses cycle through the various characters associated with each key. For instance, press the [5] key once to display the number "5" on-screen. Press it a second time (while the cursor is in the same position) to display the letter "J". The third keypress displays the letter "K" and the fourth keypress displays the letter "L". Press the key one more time to return to the number "5".

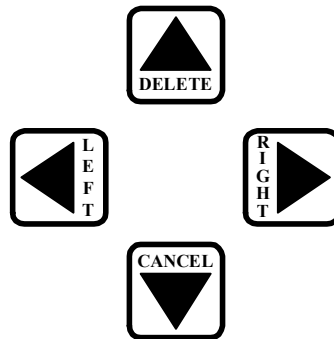

Each of the arrow keys as well as the [Back] and [Enter] keys perform specific functions within the *Controller Name Screen*.

Press the up arrow key to delete the character at the cursor position.  
Press the left arrow key to move the cursor one space to the left.  
Press the right arrow key to move the cursor one space to the right.  
Press the down arrow key to cancel out of the controller naming process.  
Press the [Back] key to insert a blank space at the cursor position.  
Press the [Enter] key to confirm the controller name as displayed on-screen.

Press "ENTER" at the end of each programming session to save the changes. If "ENTER" is not pressed the AK110 will default back to the original saved changes.

# AK110 Main Status Screen Navigation (1 of 2)

Note:  
The LCD Backlight turns off following a user-defined period of inactivity. Press any key to turn the backlight on.

The LCD screen displays 4 horizontal rows at a time. Many menus consist of 5 or more lines. Use the up and down arrow keys to navigate through longer menus to display additional menu options on-screen.

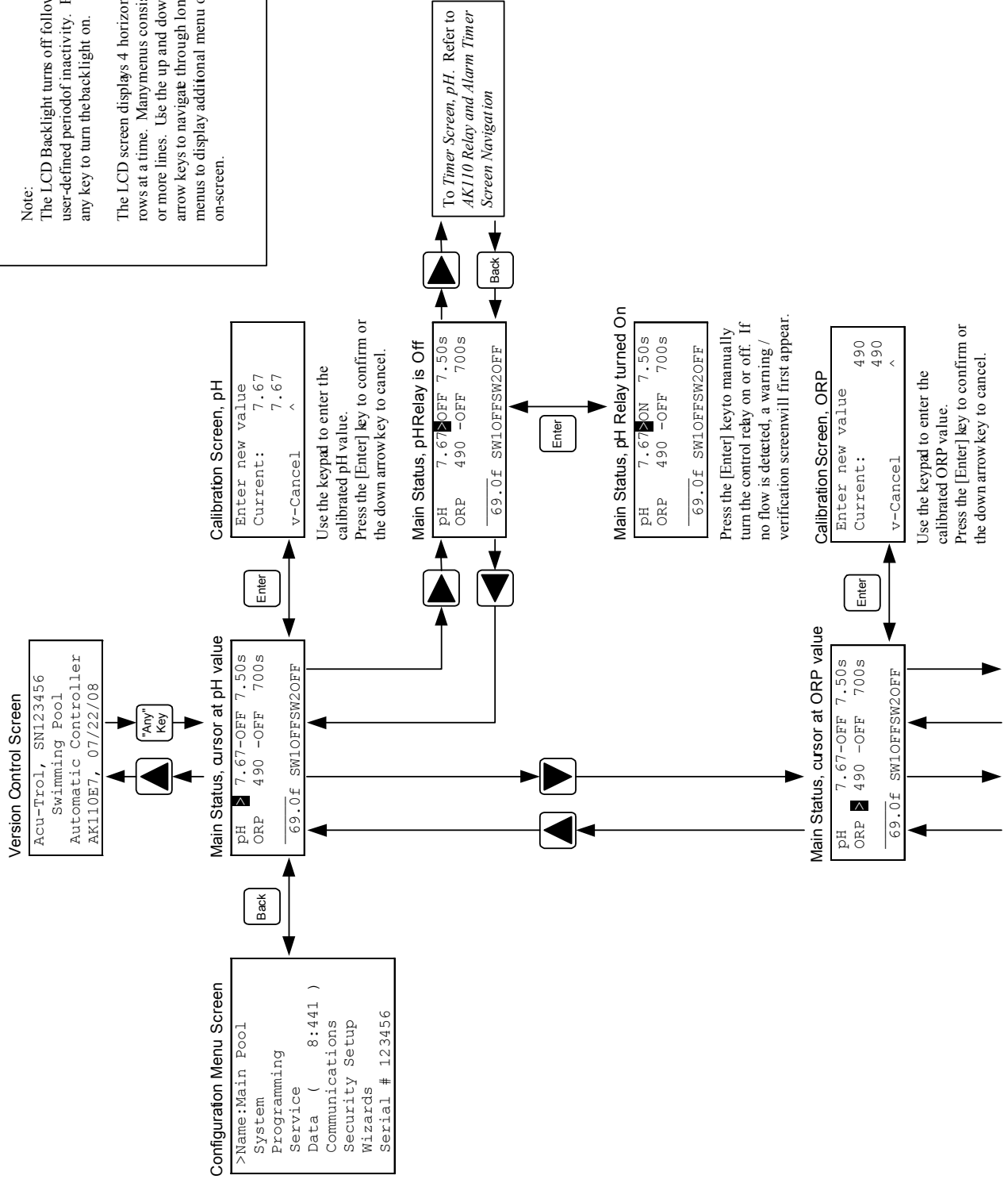

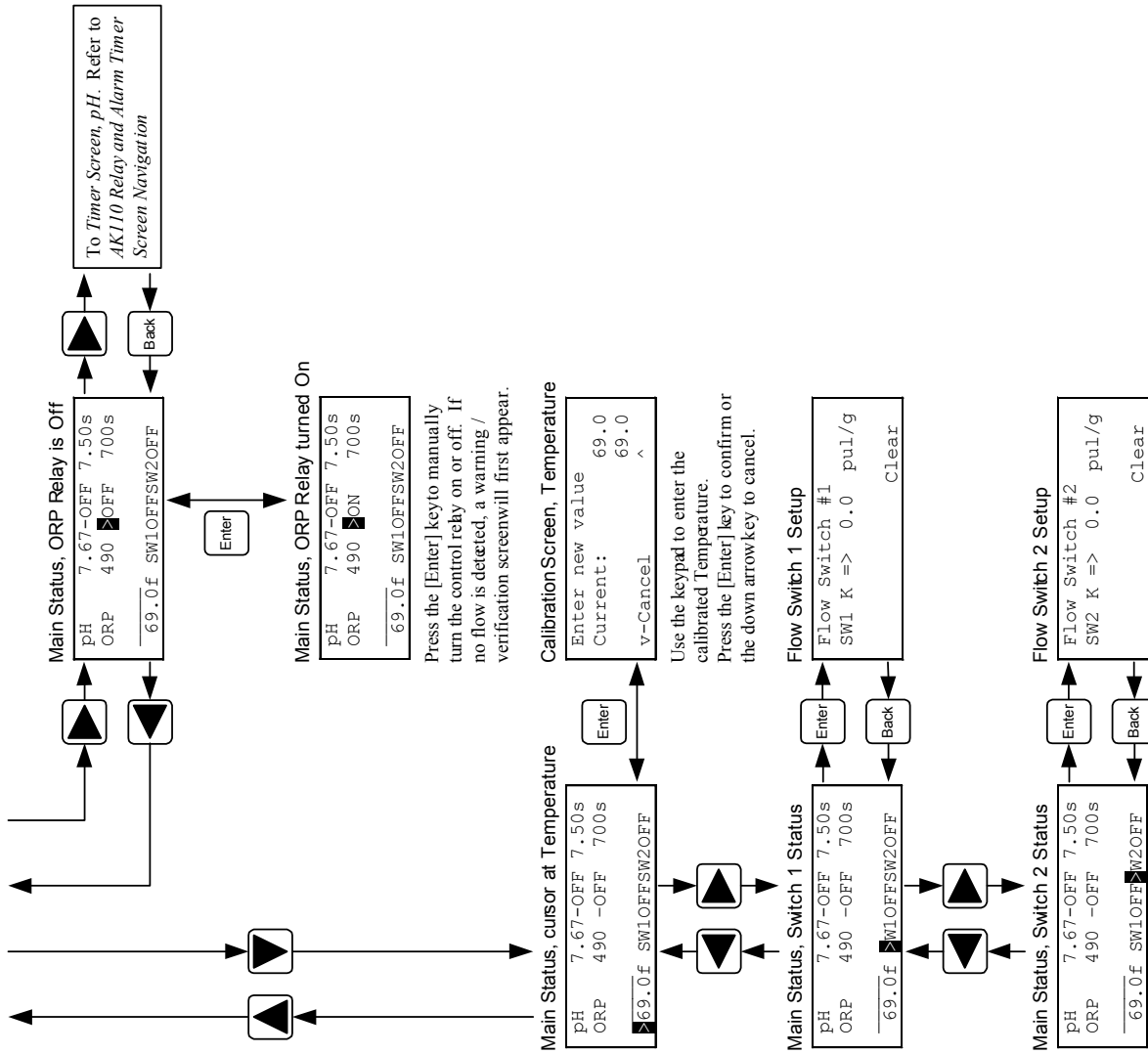

# AK110 Main Status Screen Navigation (2 of 2)

## Shortcut Keys

A number of screens may be quickly accessed directly through the *Main Status Screen*. The primary purpose of these screens is to conveniently provide system identification, configuration and diagnostic information to the user or to service personnel.

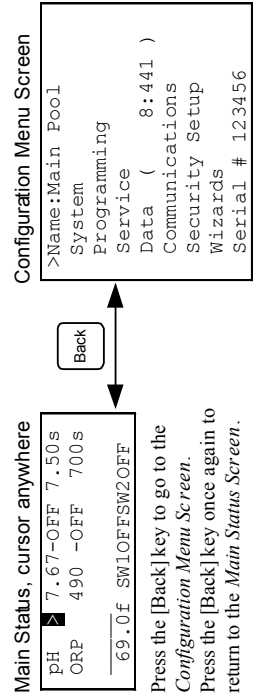
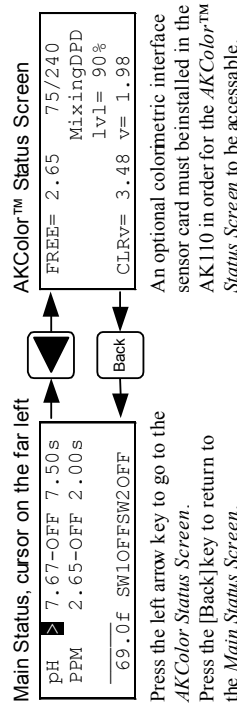
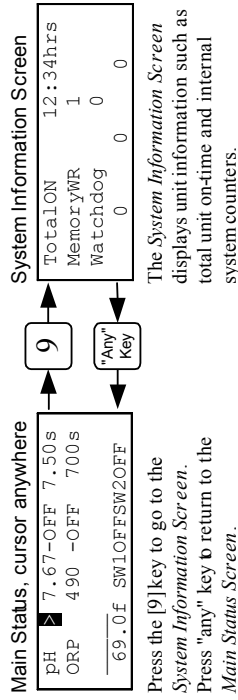
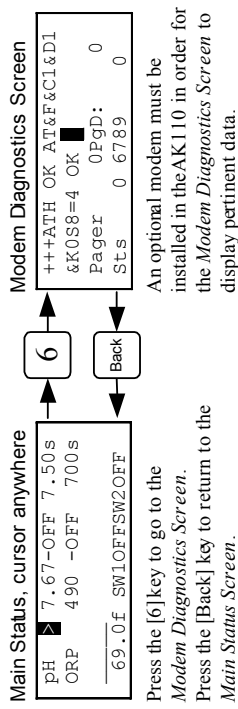
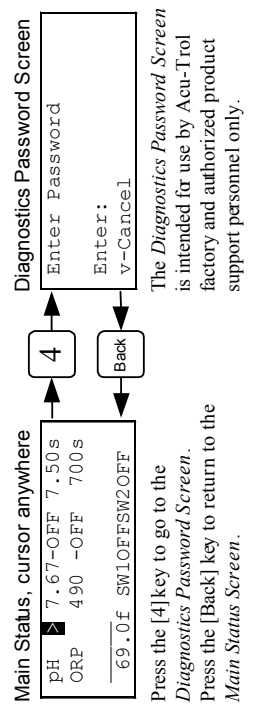
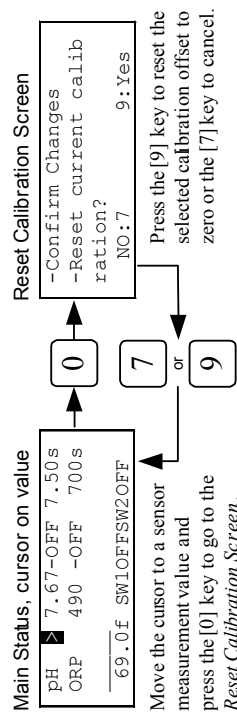
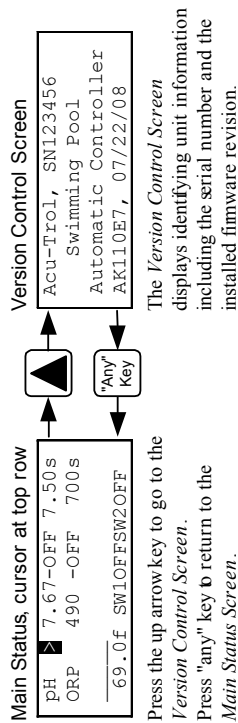



## Digital Flow Meter Setup

The two flow switch inputs are, in its default configuration, set up as simple on/off switches. One or both of these flow switch inputs may be configured to operate with a digital flow meter to measure the flow rate through a pipe.

Assigning a K-factor of "0.0" to a flow switch allows it to operate as a simple on/off flow switch. As *Flow Switch 1* functions as the default flow switch for relay control, it is recommended that it remain configured as a simple on/off flow switch.

To set up a flow switch input to operate with a digital flow meter, enter in the sensor K-factor. The flow rate is displayed on-screen as gallons per minute (g/m) or as liters per minute (l/m). Furthermore, the accumulated volume is tallied and displayed (in gallons or in liters) as the "Total" volume.

In this example, *Flow Switch 2* is configured to operate with a digital flow meter.

### Main Status, Switch 2 Flow Rate

```
pH 7.67-OFF 7.50s
ORP 490 -OFF 700s
69.0f SW1ON FM 35
```

Once *Flow Switch 2* has been configured to operate with a digital flow sensor, the measured flow rate is displayed in the "SW2" position.

### Flow Switch 2 Setup, Metric Units

```
Flow Switch #2
SW2 K = 3.6 pul/l
l/m = 83
Total = 372 >Clear
```

If the AK110 is configured to display metric units of measurement, the flow sensor values will be displayed in liters rather than gallons.

### Main Status, Cursor at Flow Switch 2

```
pH 7.67-OFF 7.50s
ORP 490 -OFF 700s
69.0f SW1OFF M2OFF
```

Back

Enter

### Flow Switch 2 Setup, K-Factor

```
Flow Switch #2
SW2 K => 0.0 pul/g
Clear
```

Enter

Enter

### Flow Switch 2 Setup, Clear Counter

```
Flow Switch #2
SW2 K = 8.5 pul/g
g/m = 35
Total = 256 >Clear
```

The unit "g/m" represents the measured flow rate. "Total" is the accumulated volume, as calculated by the flow rate and the K-factor.

### Flow Switch K-Factor Screen

```
Enter new value 0.0
Current: 0.0
v-Cancel ^
```

Use the keypad to enter the K-factor for the installed flow meter. Press the [Enter] key to confirm or the down arrow key to cancel.

### Switch 2 Setup, Clear Counter

```
Flow Switch #2
SW2 K = 8.5 pul/g
g/m = 35
Total = 0 >Clear
```

Press the [Enter] key to reset the accumulated volume counter to zero.



## Navigating Within the Timer Screen

Use the right arrow key to navigate within the *Timer Screen*. There four timer positions to cycle through:

TD: Accumulated on-time for the day.

CNT: Number of relay cycles since last reset.

S: Relay on-time without reaching setpoint.

TOT: Total on-time since the last reset.

Each of the four selectable timers can be manually reset to zero. To reset a specific timer, press the right arrow key to position the cursor next to the timer, then press the [Enter] key.

From any *Timer Screen*, press the [Back] key to return to the *Main Status Screen*.

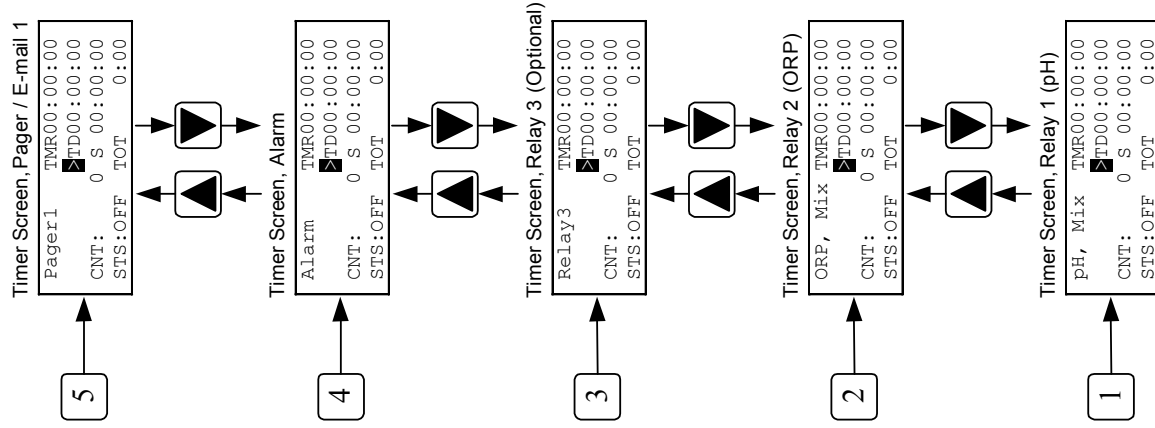
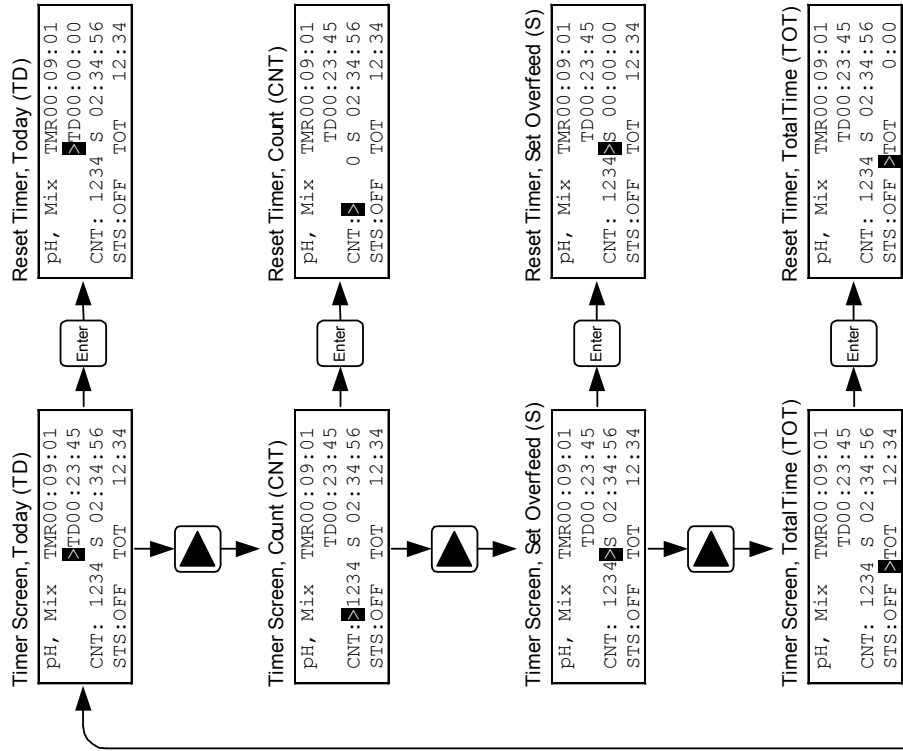

# AK110 Configuration Menu Screen Navigation

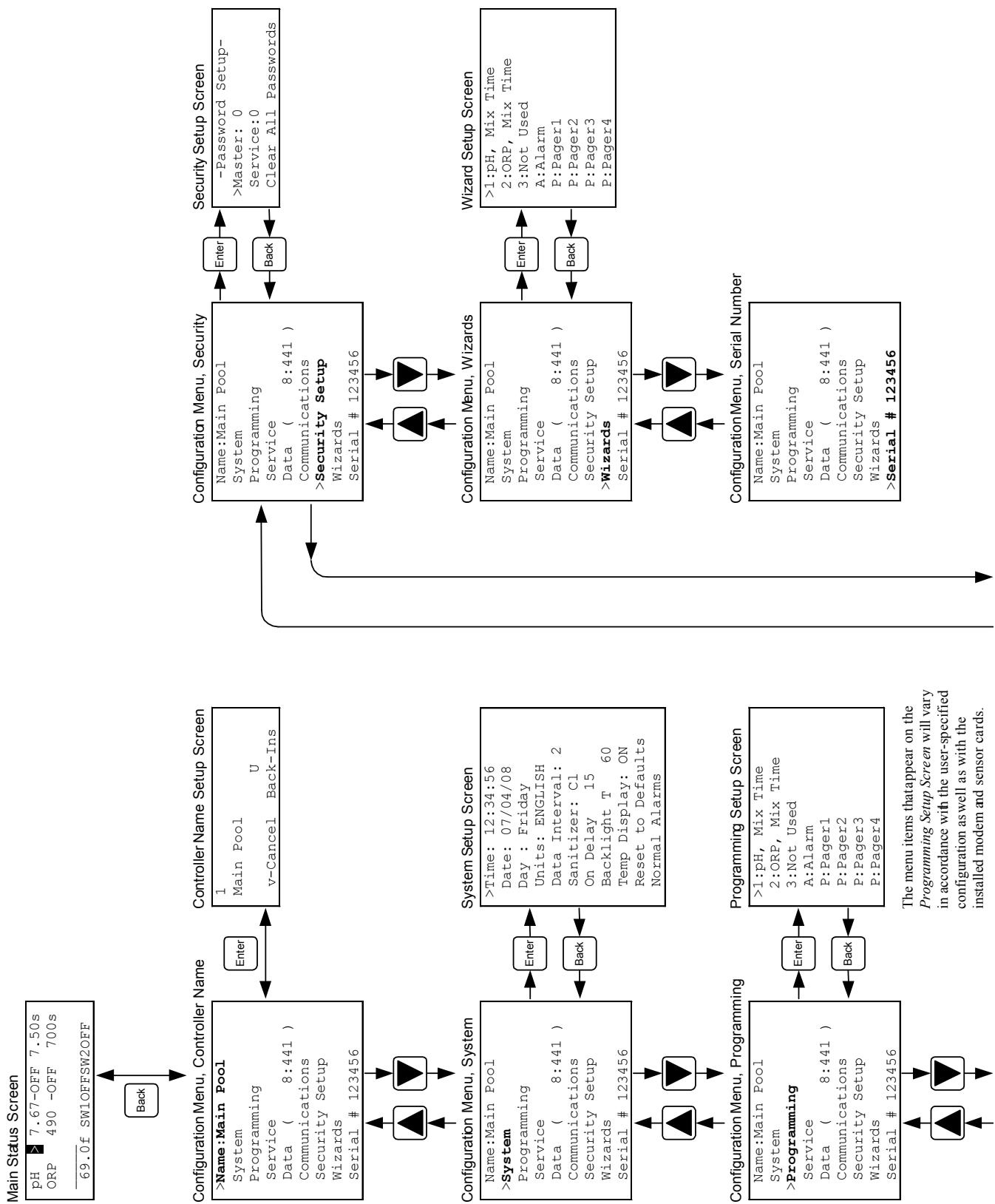

The menu items that appear on the *Programming Setup Screen* will vary in accordance with the user-specified configuration as well as with the installed modem and sensor cards.

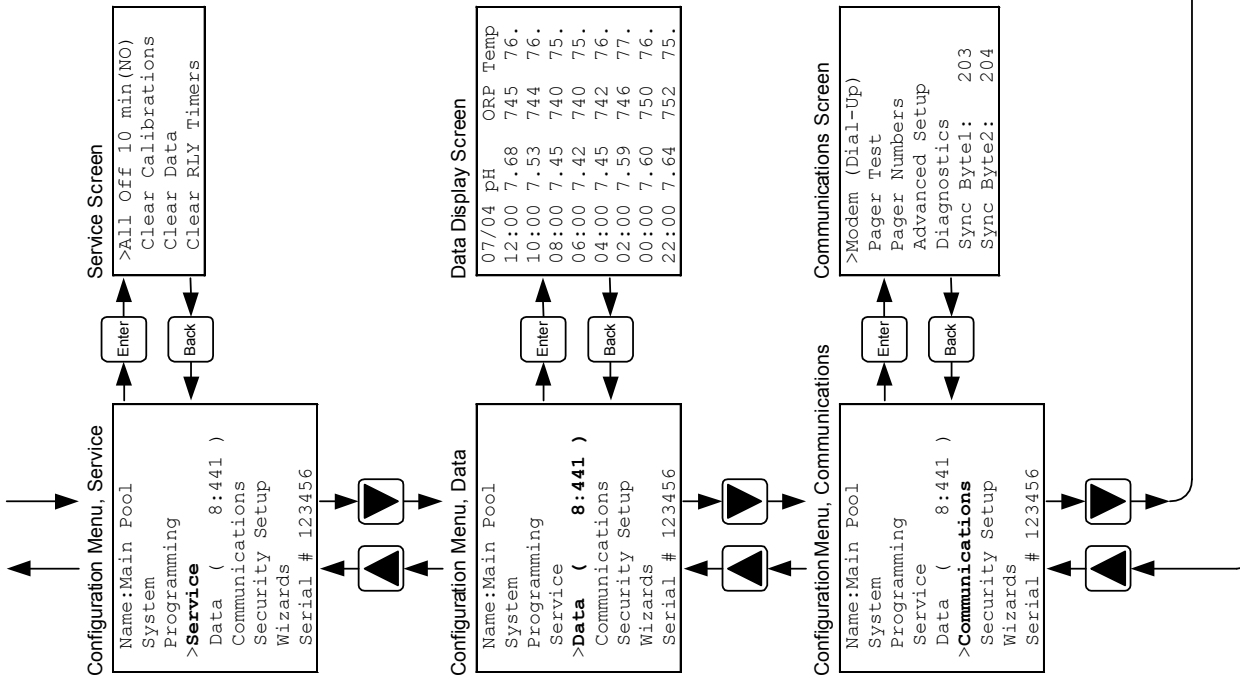

# AK110 Controller Name Screen Navigation

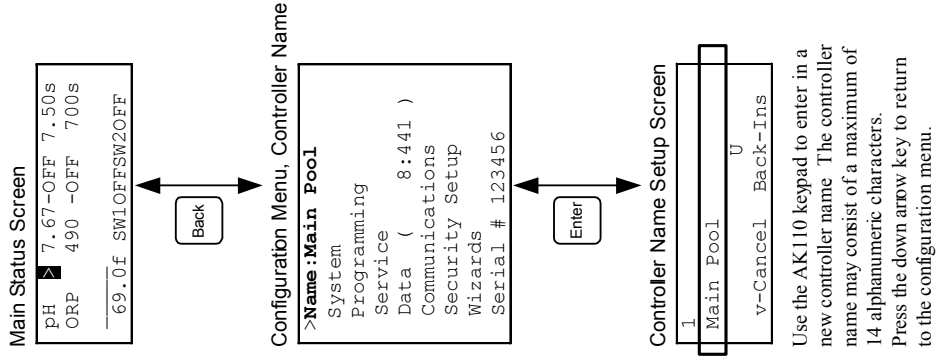

## Moving the Cursor

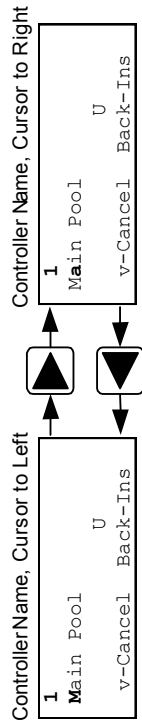

The cursor position is indicated by the character "I" located directly above the first character in the controller name. Press the right arrow key to move the cursor one space to the right.

The cursor has moved one space to the right and is now positioned directly above the second character in the controller name. Press the left arrowkey to return the cursor to its previous position.

## Changing between Upper and Lower Case Letters

To change between upper case and lower case letters, press the left arrow key until the cursor is in the leftmost position, then press the left arrow key once again. The letter "U" in the lower right corner of the display indicates whether subsequent text entered will be lower case or upper case.

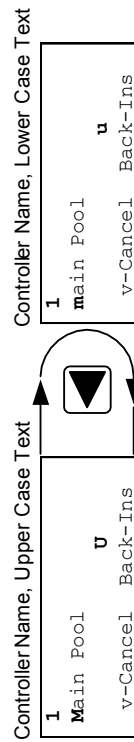

An upper case "U" in the lower right corner of the display indicates that letters entered in via the keypad will be displayed in upper case.

A lower case "u" in the lower right corner of the display indicates that letters entered in via the keypad will be displayed in lower case.

## Using the AK110 Keypad to Name the Controller

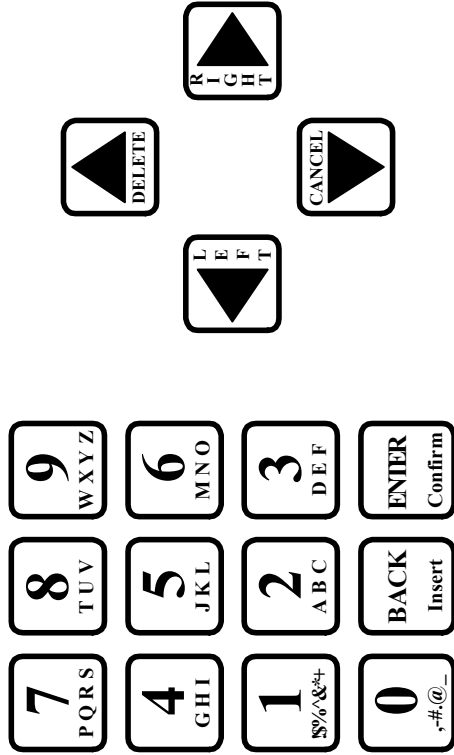

Each numeric key is associated with three or more letters of the alphabet, or with punctuation and other special characters.

Successive keypresses cycle through the various characters associated with each key. For instance, press the [5] key once to display the number "5" on-screen.

Press it a secondtime (while the cursor is in the same position) to display the letter "J". The third keypress displays the letter "K" and the fourth keypress displays the letter "L". Press thekey one more time to return to the number "5".

Each of the arrow keys as well as the [Back] and [Enter] keys perform specific functions within the *Controller Name Screen*.

Press the up arrowkey to delete the character at the cursor position.

Press the left arrow key to move the cursor one space to the left.

Press the right arrow key to move the cursor one space to the right.

Press the down arrowkey to cancel out of the controller naming process.

Press the [Back] key to insert a blank space at the cursor position.

Press the [Enter] key to confirm the controller name as displayed on-screen.

# AK110 System Setup Screen Navigation

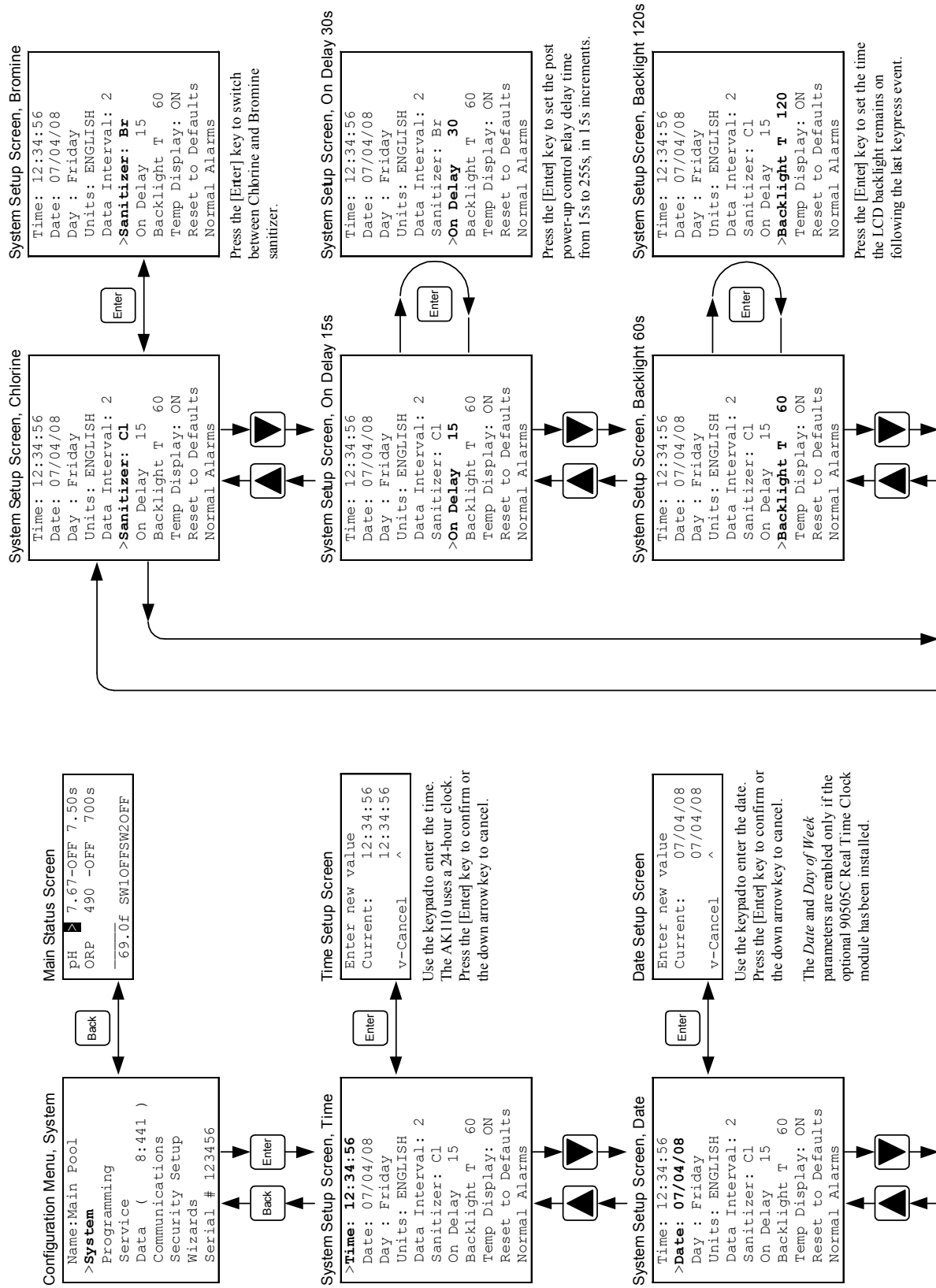



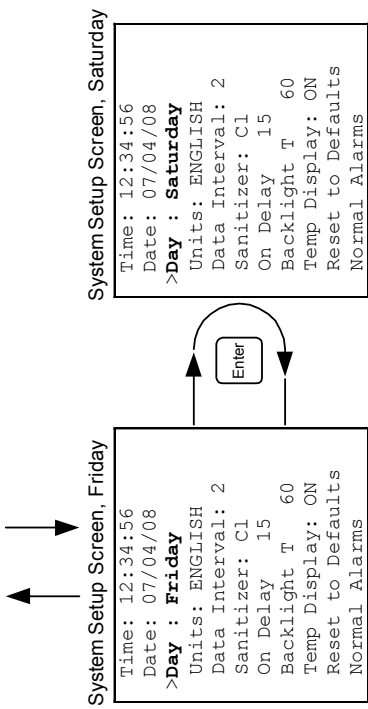

Press the [Enter] key to cycle through the days of the week.

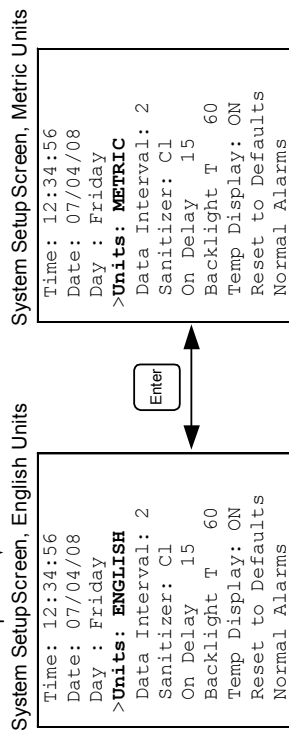

Press the [Enter] key to switch between English and Metric units of measurement.

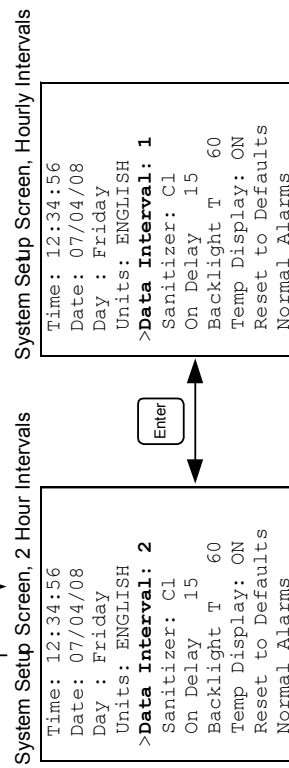

Press the [Enter] key to record information in the data log every two hours or every hour.

# AK110 Programming Screen Navigation, pH Mix Time (1 of 2)

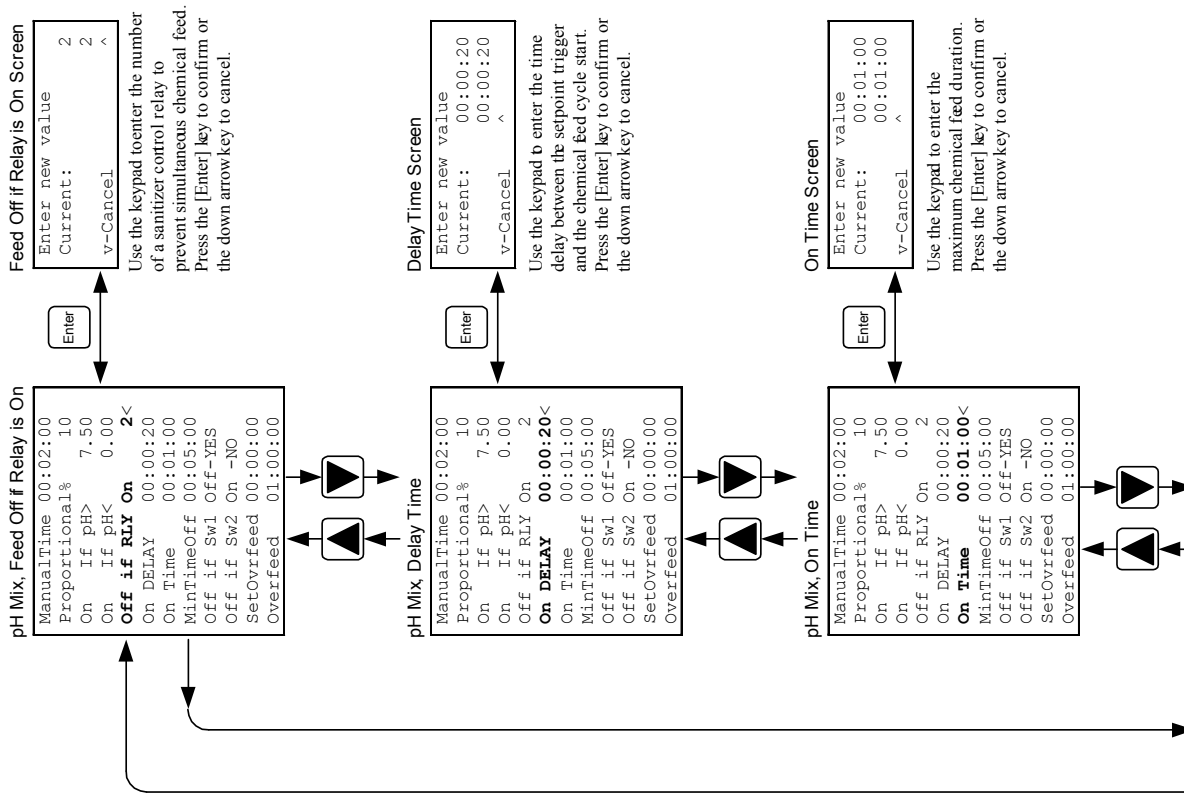
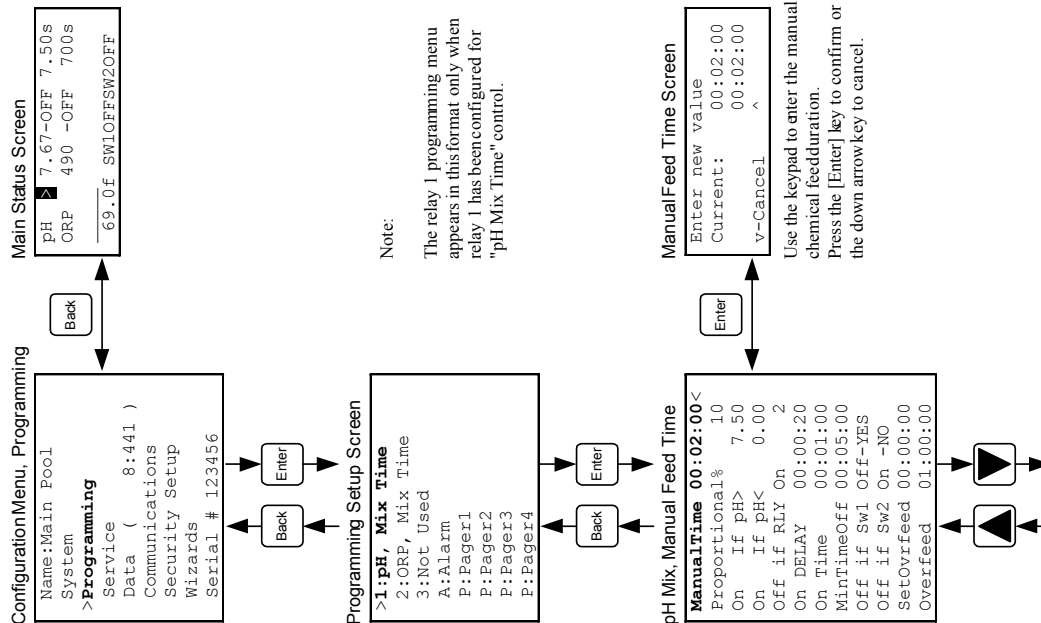

pH Mix , Proportional Feed Percent

ManualTime 00:02:00  
Proportional% 10<  
On If pH> 7.50  
On If pH< 0.00  
Off If RLY On 2  
On DELAY 00:00:20  
On Time 00:01:00  
MinTimeOff 00:05:00  
Off If Sw1 Off-YES  
Off If Sw2 On -NO  
SetOvrfeed 00:00:00  
Overfeed 01:00:00

Enter

Enter new value  
Current: 10  
v-Cancel ^

Use the keypad to enter the proportional feed percentage. Press the [Enter] key to confirm or the down arrow key to cancel.

pH Mix, Minimum Time Off

ManualTime 00:02:00  
Proportional% 10  
On If pH> 7.50  
On If pH< 0.00  
Off If RLY On 2  
On DELAY 00:00:20  
On Time 00:01:00  
MinTimeOff 00:05:00<  
Off If Sw1 Off-YES  
Off If Sw2 On -NO  
SetOvrfeed 00:00:00  
Overfeed 01:00:00

Enter

Enter new value  
Current: 00:05:00  
v-Cancel ^

Use the keypad to enter the amount of time the relay will be held off during a feed cycle to allow mixing. Press the [Enter] key to confirm or the down arrow key to cancel.

pH Mix, Acid Feed Setpoint

ManualTime 00:02:00  
Proportional% 10  
On If pH> 7.50<  
On If pH< 0.00  
Off If RLY On 2  
On DELAY 00:00:20  
On Time 00:01:00  
MinTimeOff 00:05:00  
Off If Sw1 Off-YES  
Off If Sw2 On -NO  
SetOvrfeed 00:00:00  
Overfeed 01:00:00

Enter

Enter new value  
Current: 7.50  
v-Cancel ^

Use the keypad to enter the pH setpoint for acid feed control. Press the [Enter] key to confirm or the down arrow key to cancel.

pH Mix, Feed Off if SW1 is Off

ManualTime 00:02:00  
Proportional% 10  
On If pH> 7.50  
On If pH< 0.00  
Off If RLY On 2  
On DELAY 00:00:20  
On Time 00:01:00  
MinTimeOff 00:05:00  
Off If Sw1 Off-YES <  
Off If Sw2 On -NO  
SetOvrfeed 00:00:00  
Overfeed 01:00:00

Enter

ManualTime 00:02:00  
Proportional% 10  
On If pH> 7.50  
On If pH< 0.00  
Off If RLY On 2  
On DELAY 00:00:20  
On Time 00:01:00  
MinTimeOff 00:05:00  
Off If Sw1 Off-YES <  
Off If Sw2 On -NO  
SetOvrfeed 00:00:00  
Overfeed 01:00:00

Press the [Enter] key to make the chemical feed dependent or independent of the status of the flow switch SW1.

Proportional Feed Percent Screen

Enter new value  
Current: 10  
v-Cancel ^

Use the keypad to enter the proportional feed percentage. Press the [Enter] key to confirm or the down arrow key to cancel.

pH Mix, Independent of SW2

ManualTime 00:02:00  
Proportional% 10  
On If pH> 7.50  
On If pH< 0.00  
Off If RLY On 2  
On DELAY 00:00:20  
On Time 00:01:00  
MinTimeOff 00:05:00  
Off If Sw1 Off-YES  
Off If Sw2 On -NO <  
SetOvrfeed 00:00:00  
Overfeed 01:00:00

Enter

ManualTime 00:02:00  
Proportional% 10  
On If pH> 7.50  
On If pH< 0.00  
Off If RLY On 2  
On DELAY 00:00:20  
On Time 00:01:00  
MinTimeOff 00:05:00  
Off If Sw1 Off-YES  
Off If Sw2 On -YES <  
SetOvrfeed 00:00:00  
Overfeed 01:00:00

Press the [Enter] key to make the chemical feed dependent or independent of the status of switch 2 (SW2.)

pH Mix, Base Feed Setpoint

ManualTime 00:02:00  
Proportional% 10  
On If pH> 7.50  
On If pH< 0.00<  
Off If RLY On 2  
On DELAY 00:00:20  
On Time 00:01:00  
MinTimeOff 00:05:00  
Off If Sw1 Off-YES  
Off If Sw2 On -NO  
SetOvrfeed 00:00:00  
Overfeed 01:00:00

Enter

Enter new value  
Current: 0.00  
v-Cancel ^

Use the keypad to enter the pH setpoint for base feed control. Press the [Enter] key to confirm or the down arrow key to cancel.

pH Mix, Feed Off if SW2 is On

ManualTime 00:02:00  
Proportional% 10  
On If pH> 7.50  
On If pH< 0.00  
Off If RLY On 2  
On DELAY 00:00:20  
On Time 00:01:00  
MinTimeOff 00:05:00  
Off If Sw1 Off-YES  
Off If Sw2 On -YES <  
SetOvrfeed 00:00:00  
Overfeed 01:00:00

Enter

ManualTime 00:02:00  
Proportional% 10  
On If pH> 7.50  
On If pH< 0.00  
Off If RLY On 2  
On DELAY 00:00:20  
On Time 00:01:00  
MinTimeOff 00:05:00  
Off If Sw1 Off-YES  
Off If Sw2 On -YES <  
SetOvrfeed 00:00:00  
Overfeed 01:00:00

Press the [Enter] key to make the chemical feed dependent or independent of the status of the flow switch SW1.

To pH Mix Time (2 of 2)





# AK110 Programming Screen Navigation, ORP Mix Time (1 of 2)

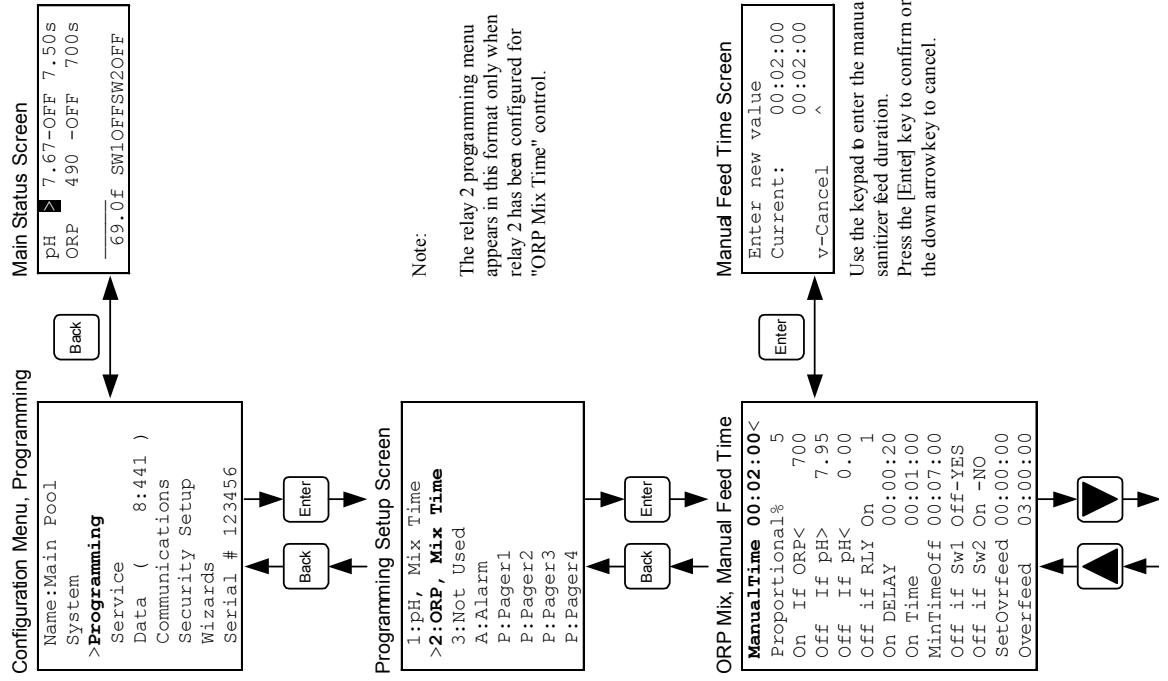

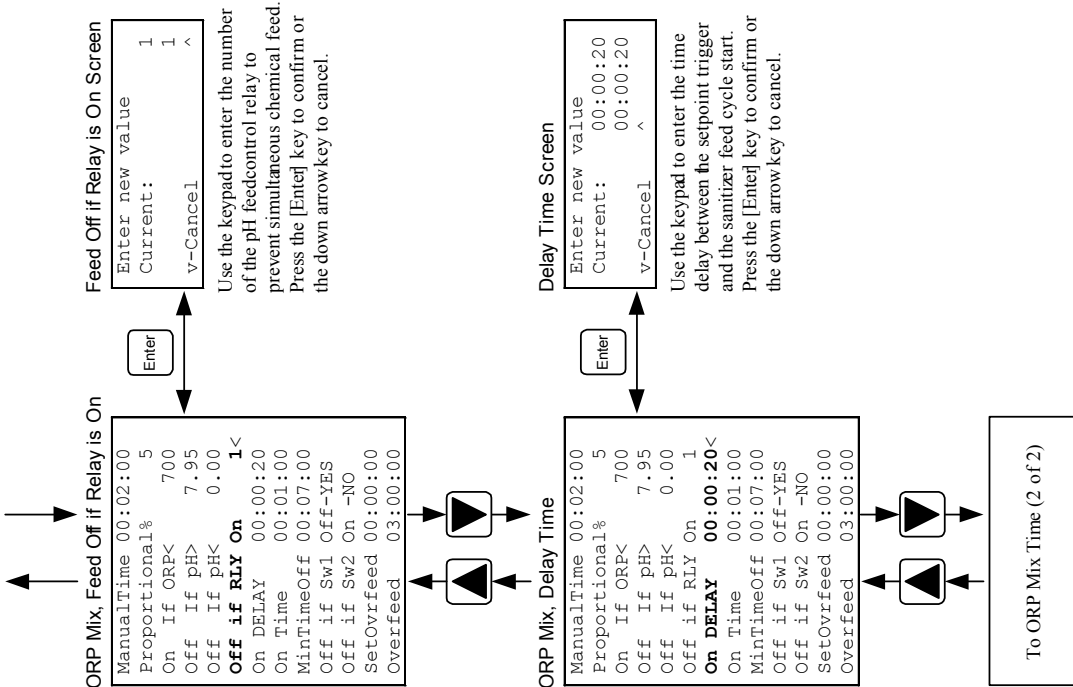
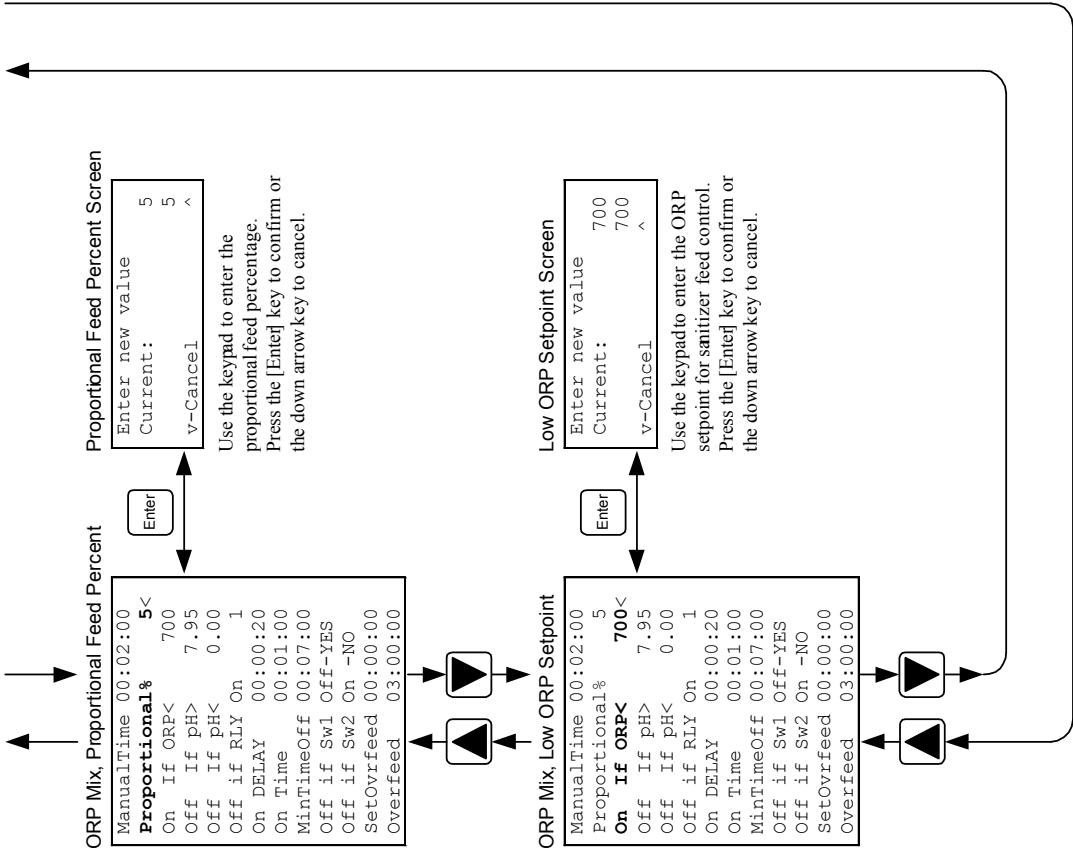

# AK110 Programming Screen Navigation, ORP Mix Time (2 of 2)

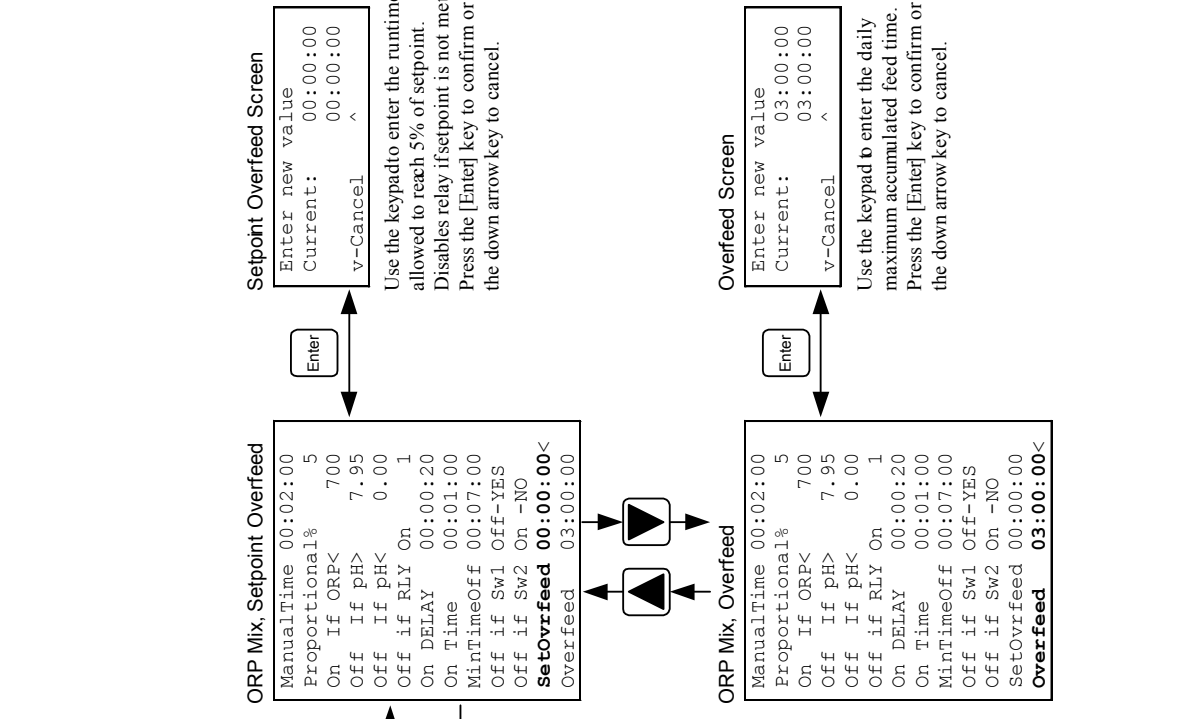
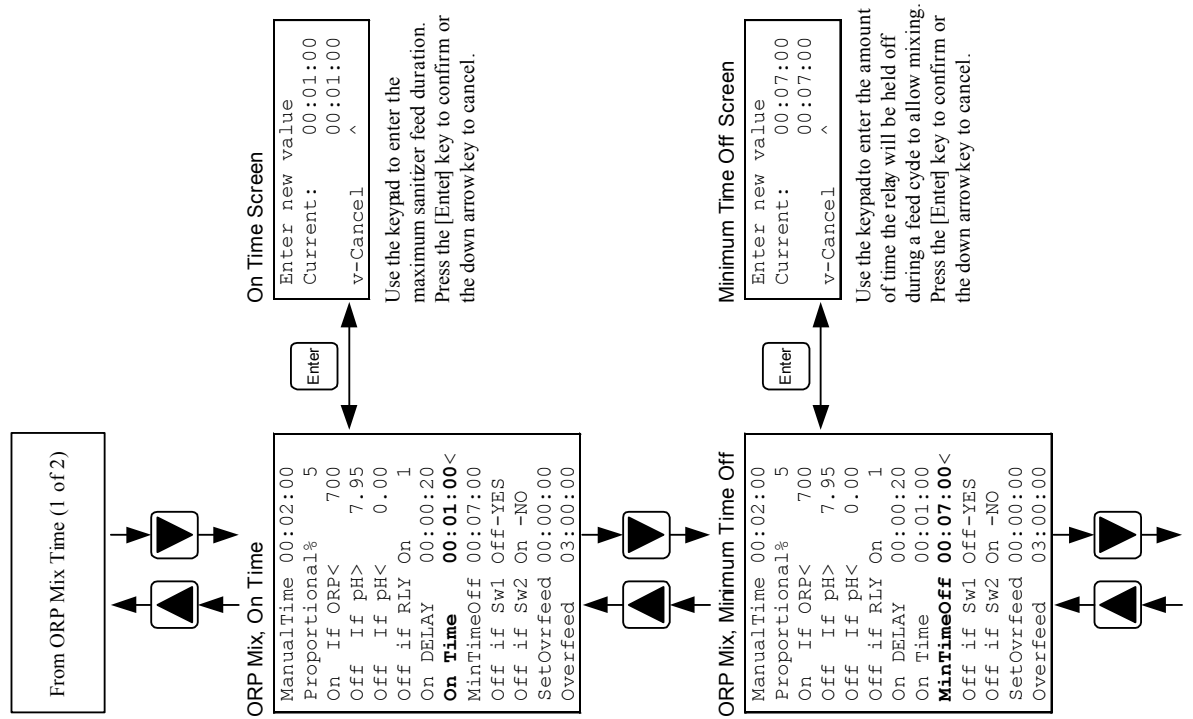



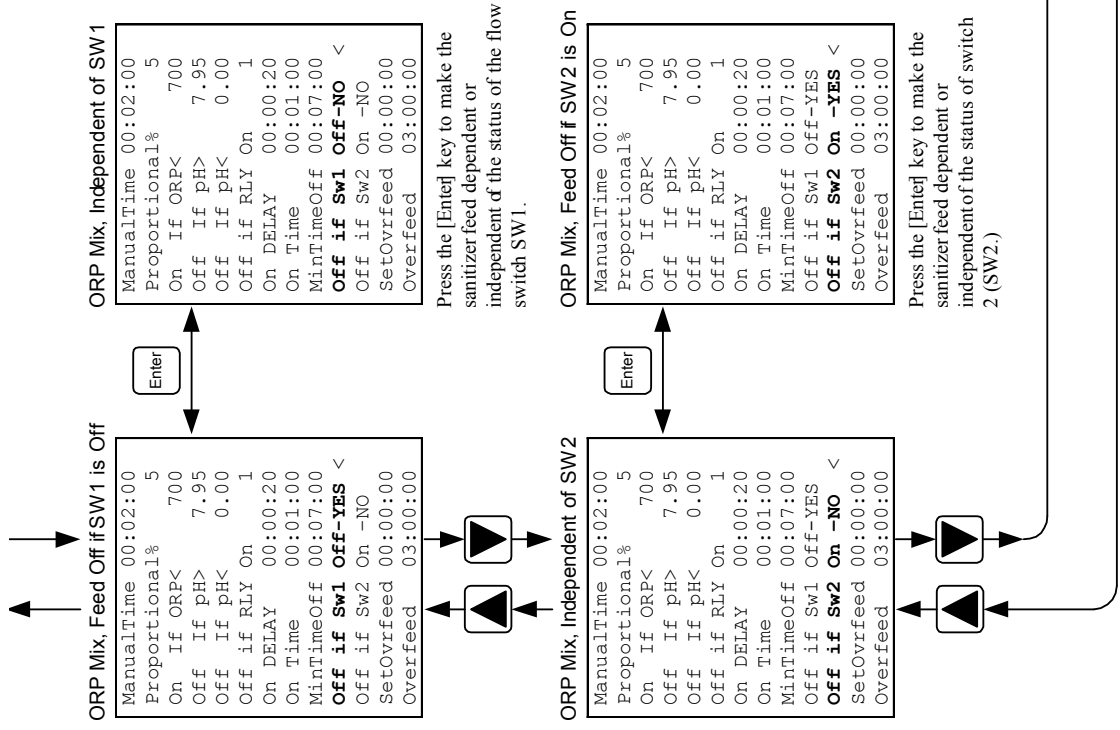

# AK110 Programming Screen Navigation, ORP Cycle Time (1 of 2)

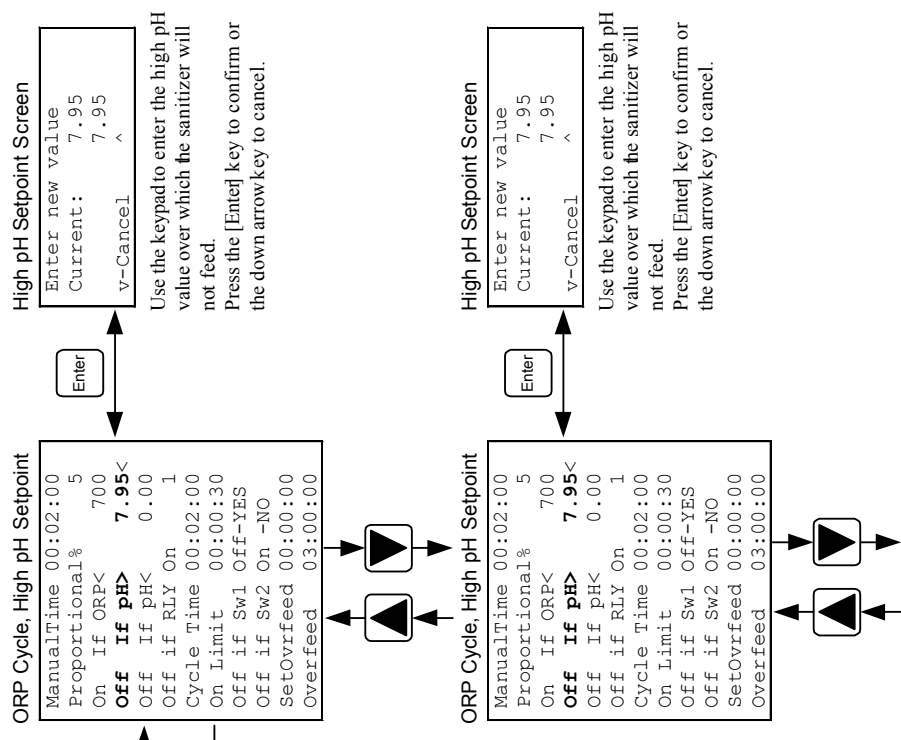
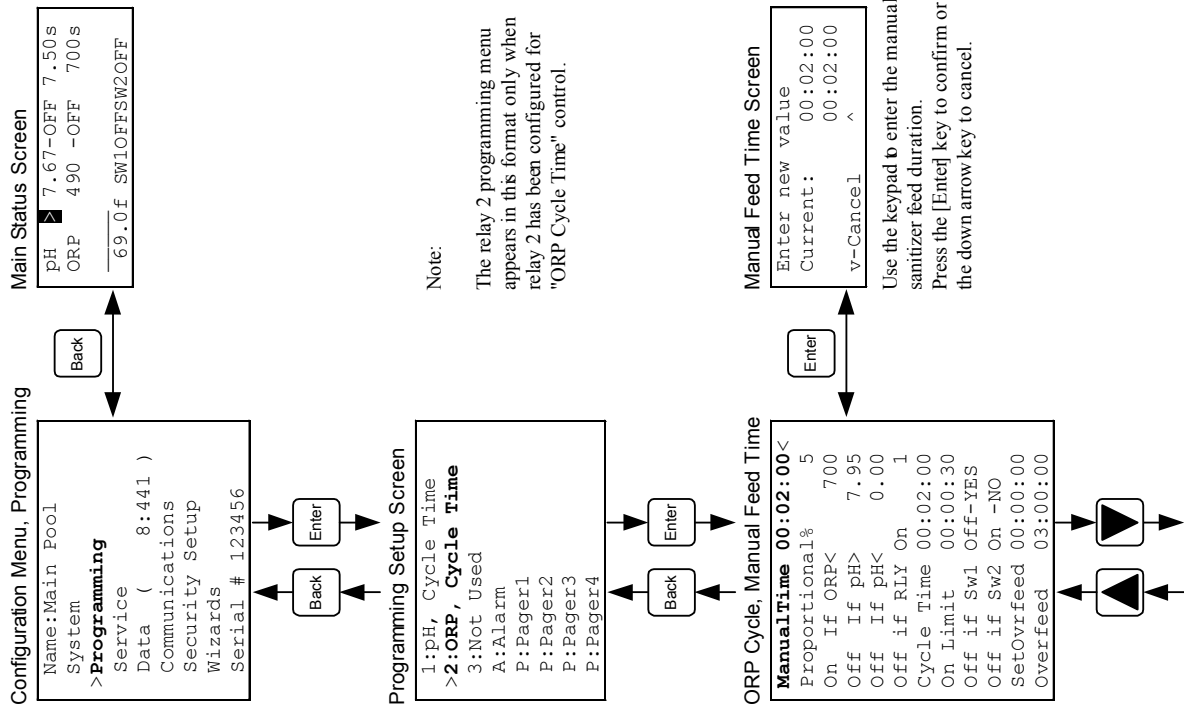

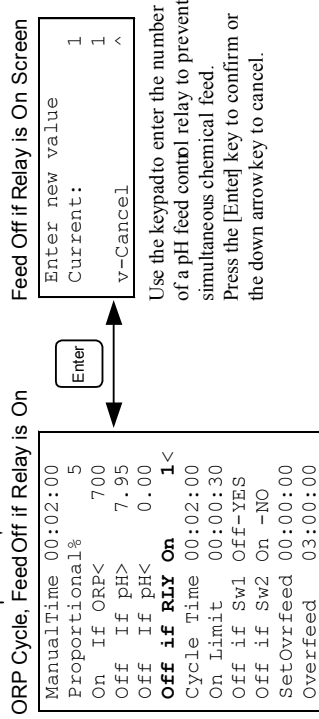
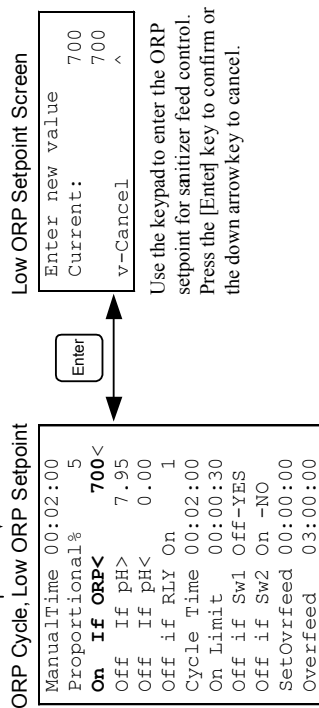
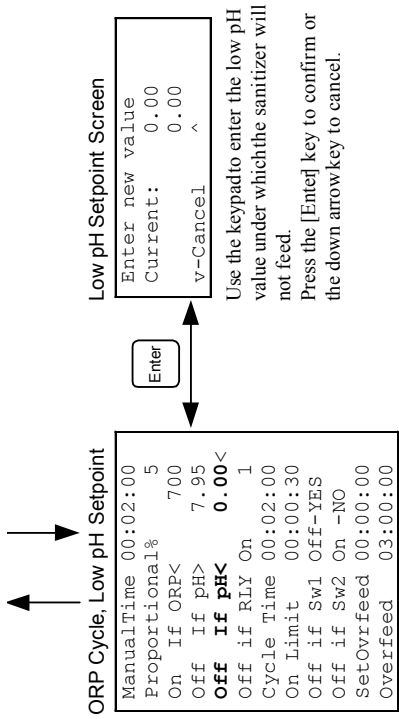
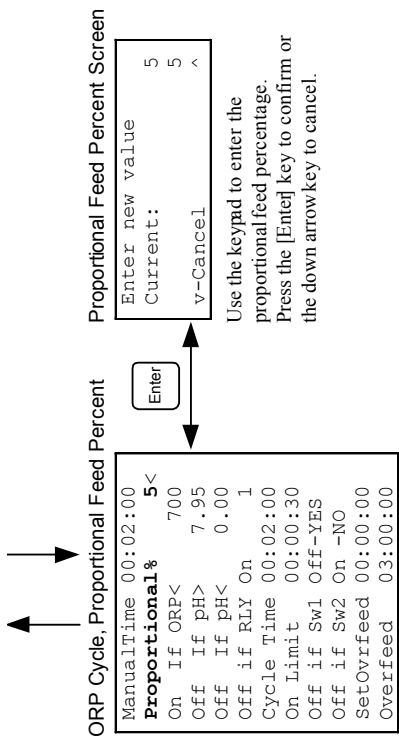

To ORP Cycle Time (2 of 2)

# AK110 Programming Screen Navigation, ORP Cycle Time (2 of 2)

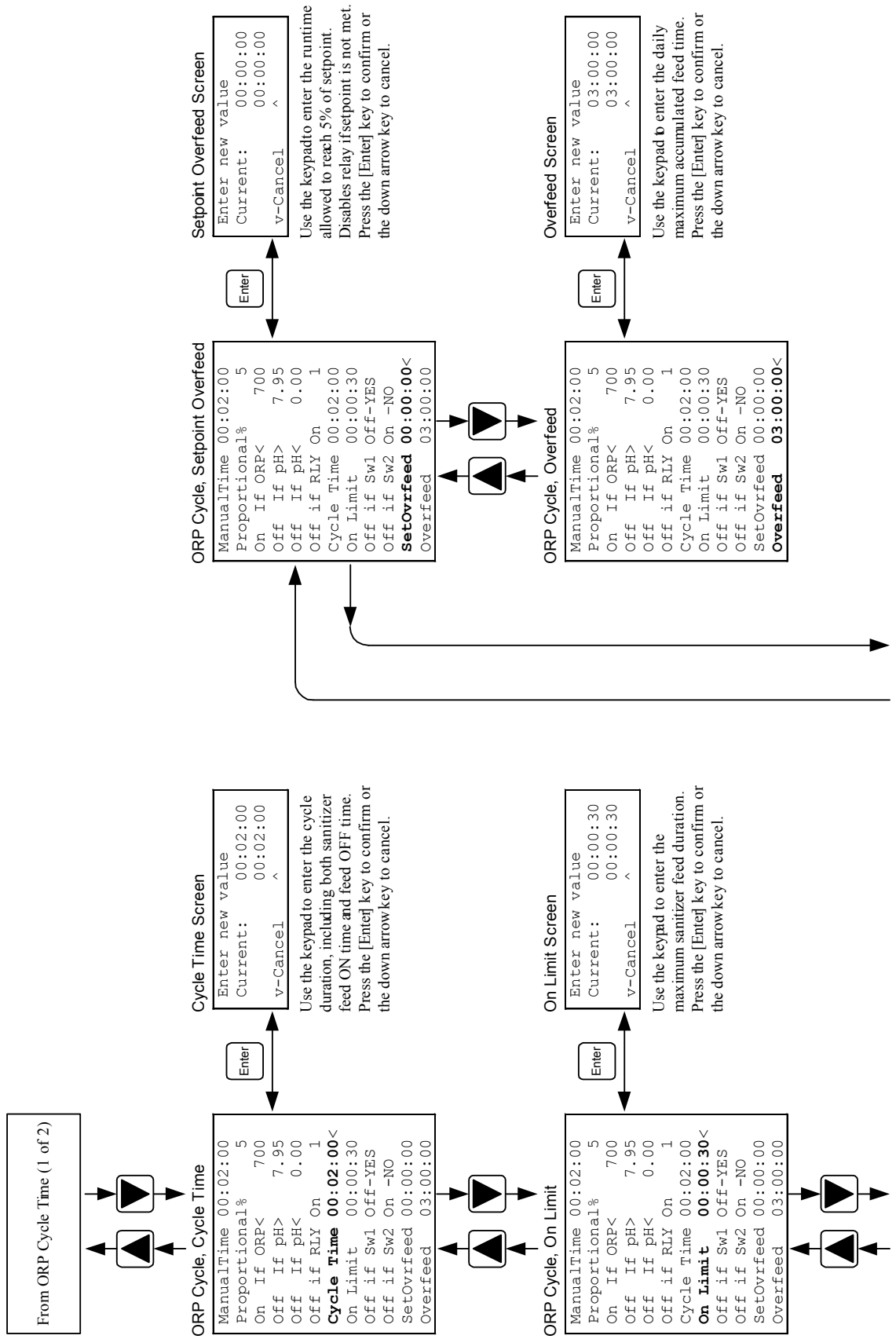

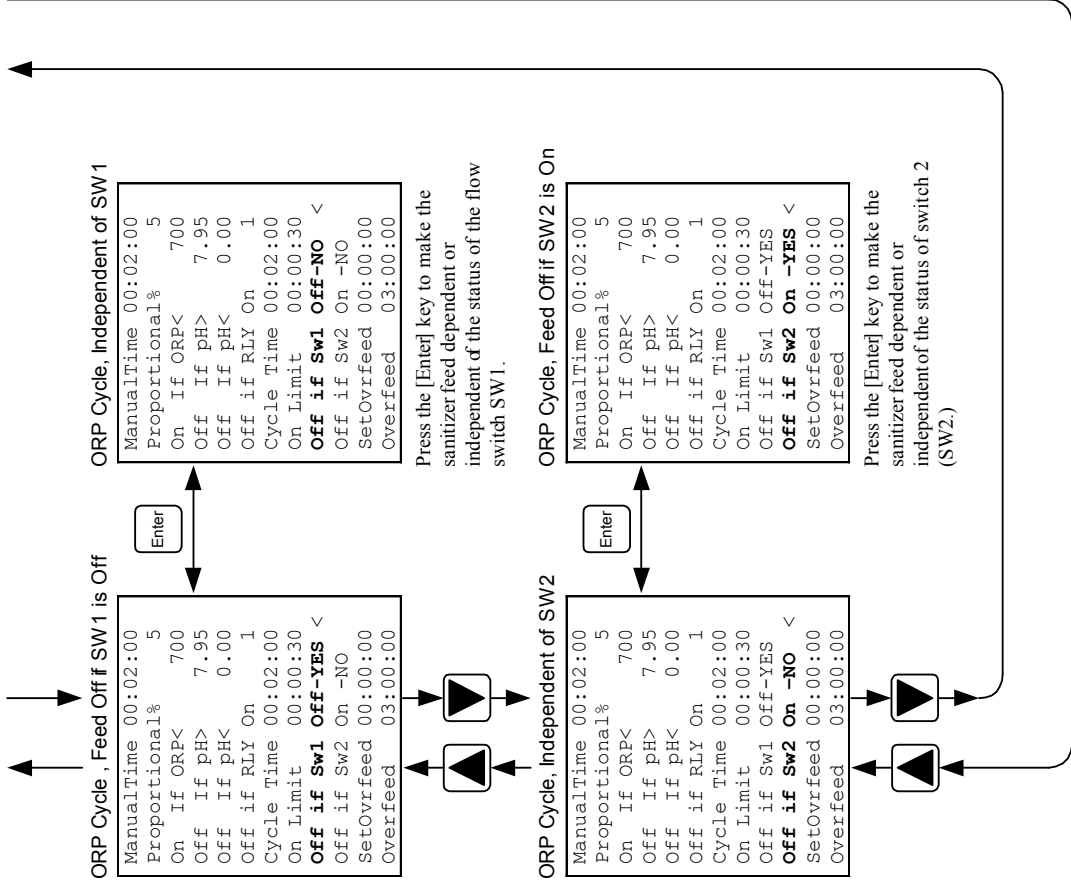

# AK110 Programming Screen Navigation, ORP Cal Hypo (1 of 2)

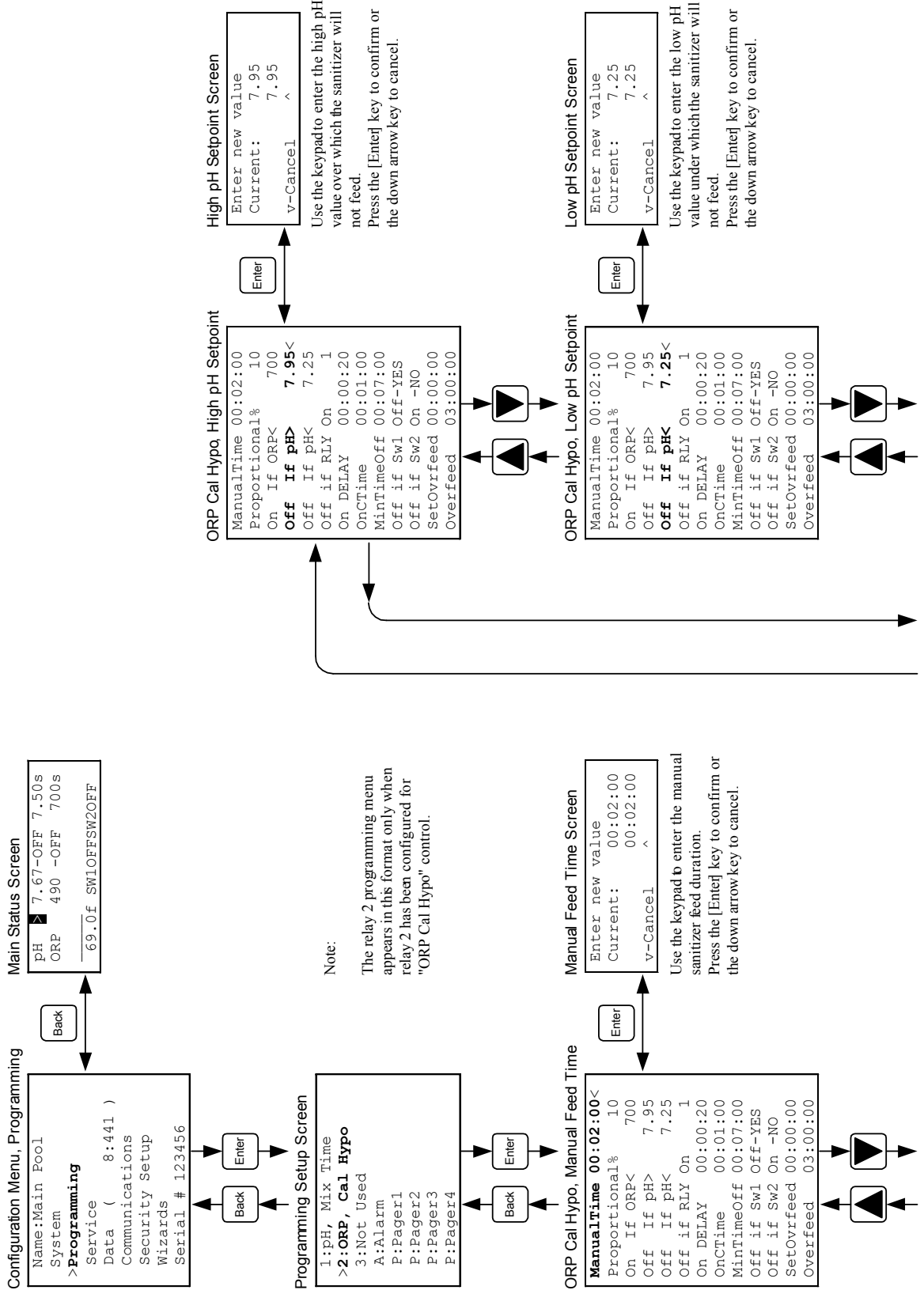

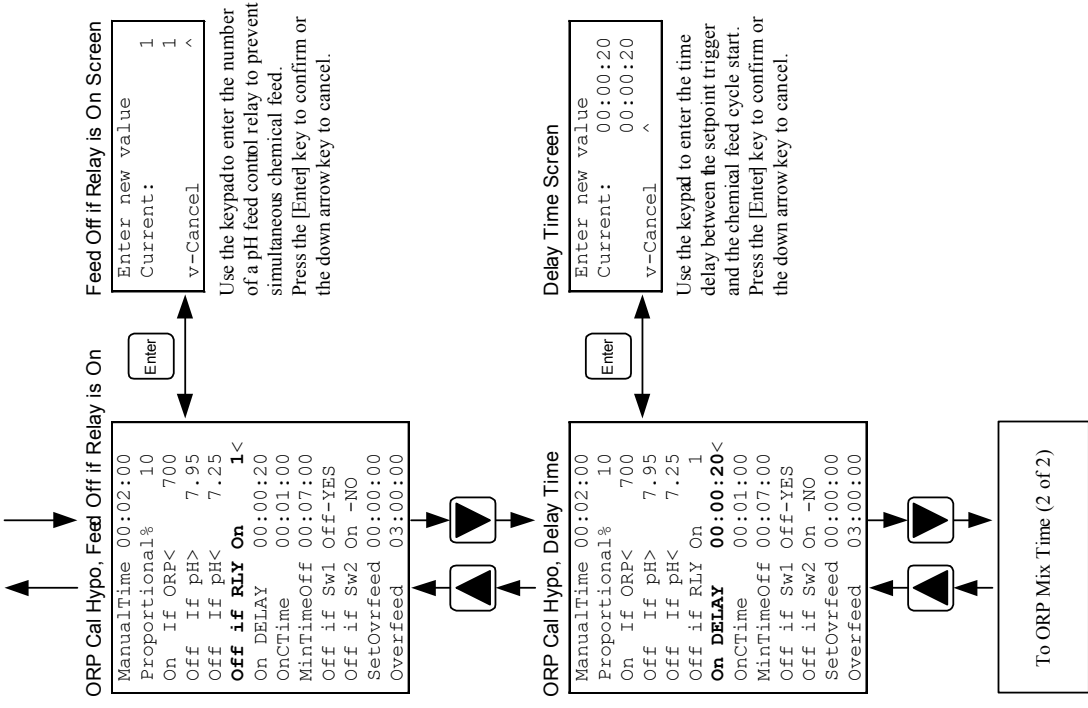
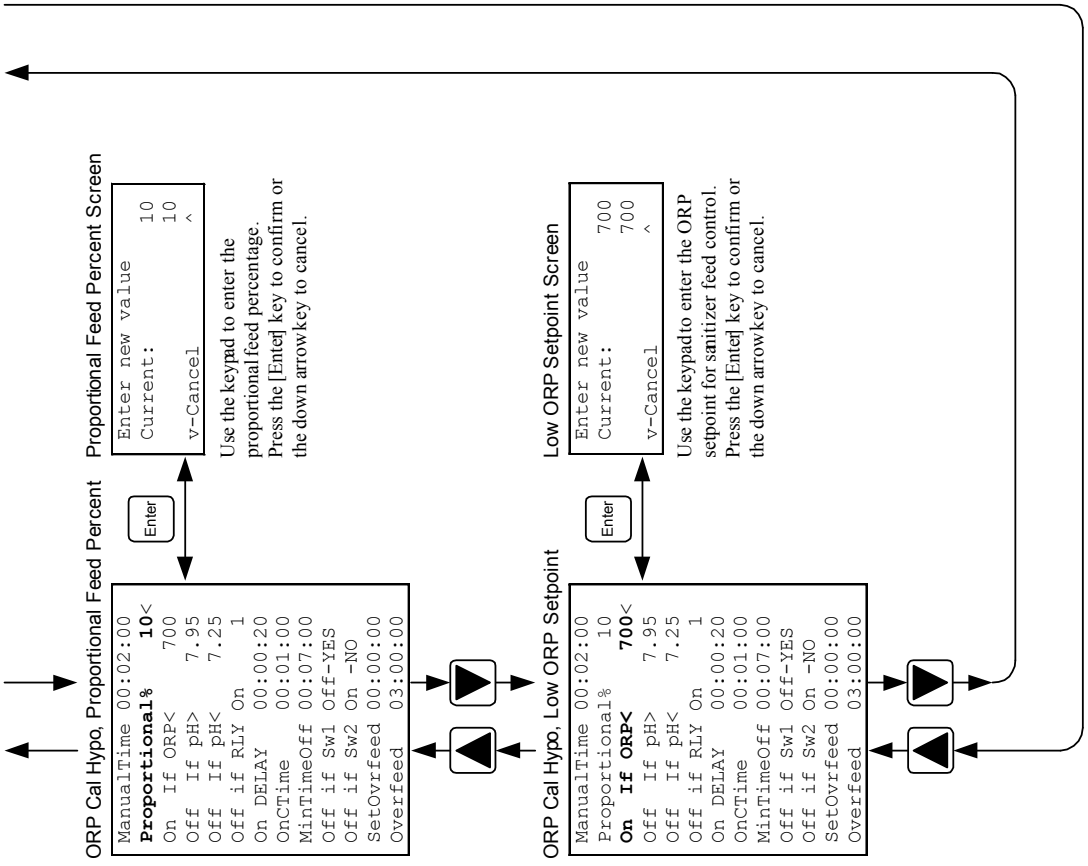

# AK110 Programming Screen Navigation, ORP Cal Hypo (2 of 2)

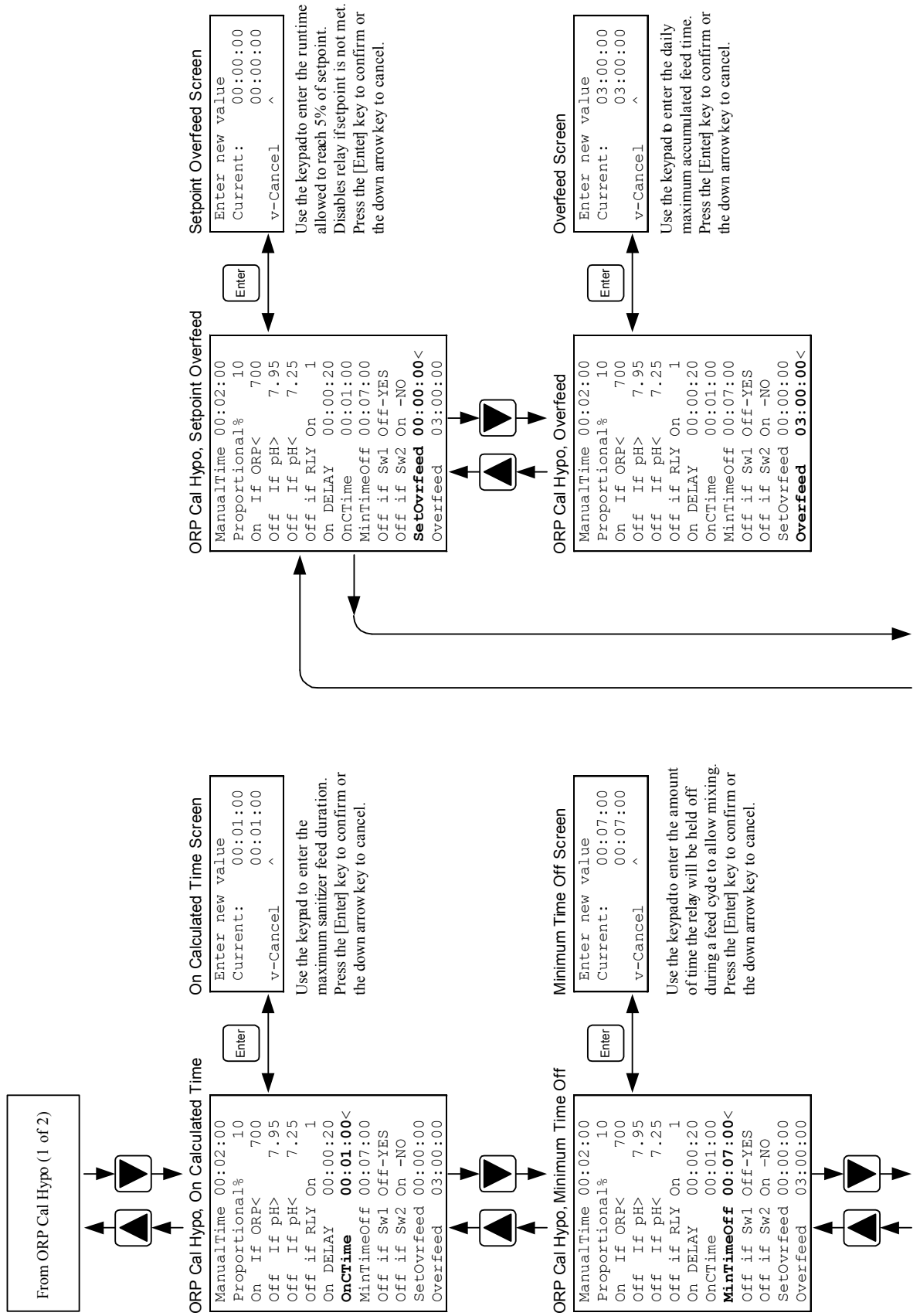



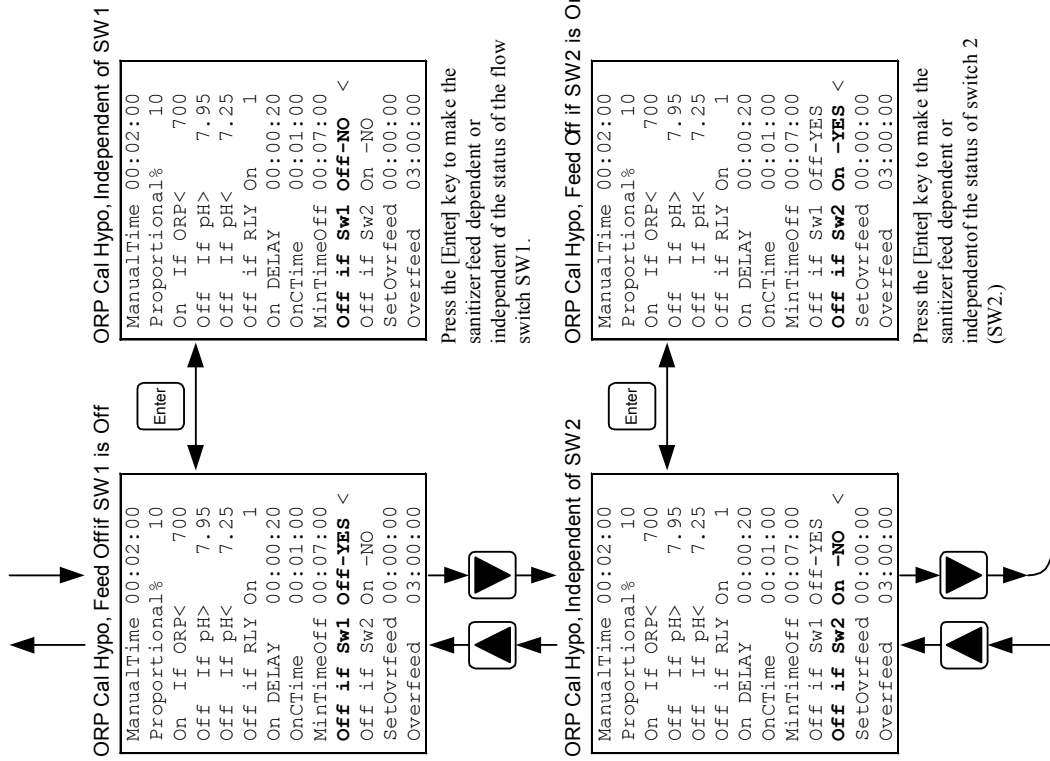

# AK110 Programming Screen Navigation, PPM Cycle Time (1 of 2)

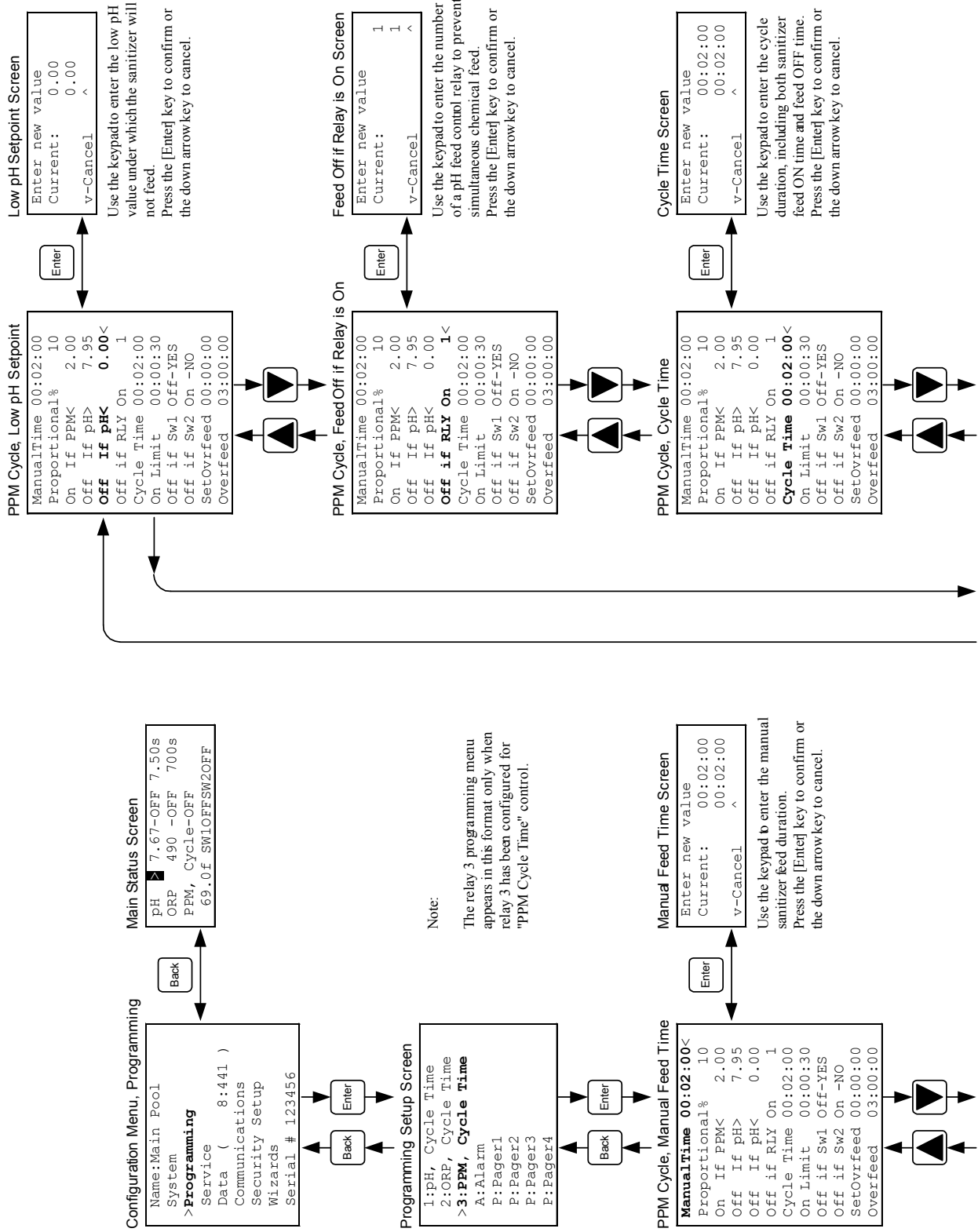

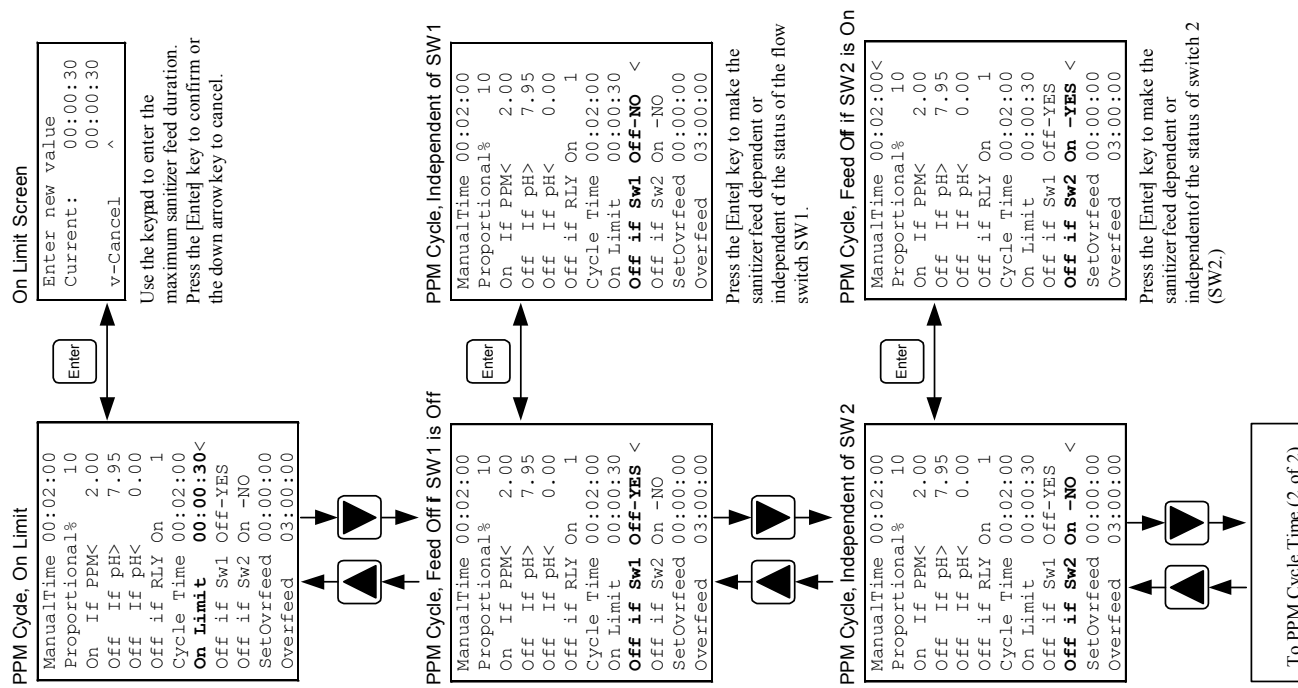
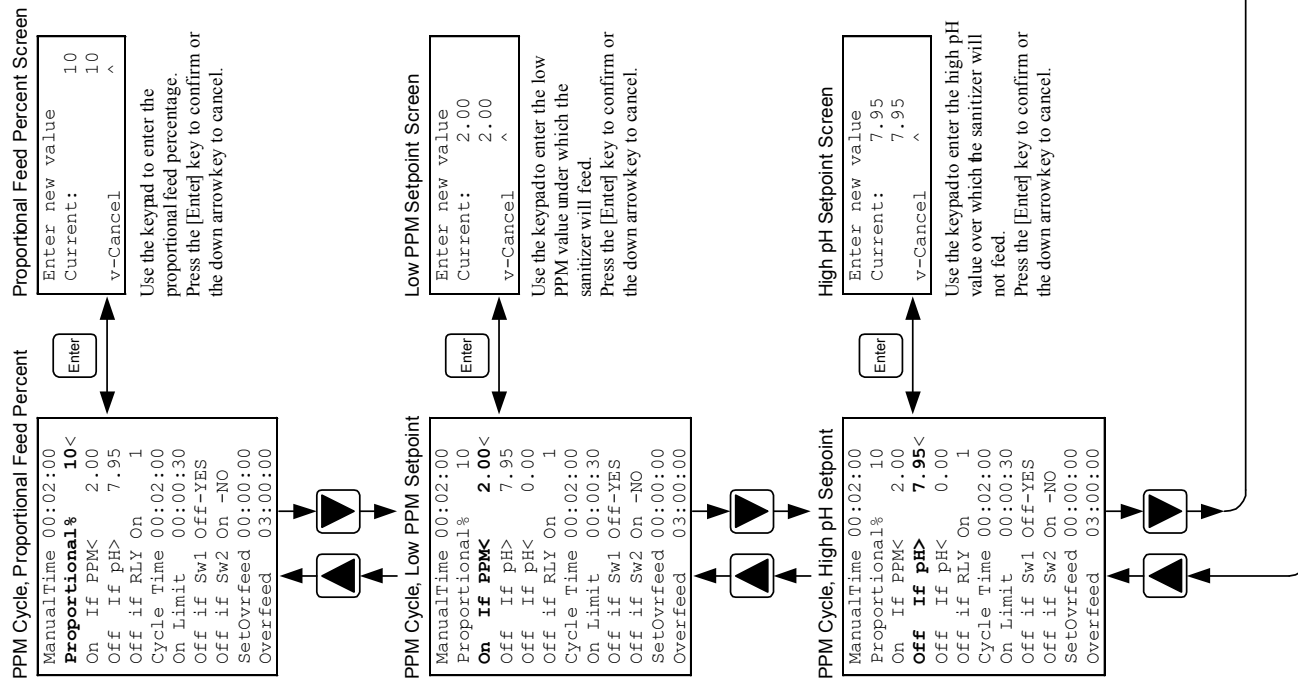

# AK110 Programming Screen Navigation, PPM Cycle Time (2 of 2)

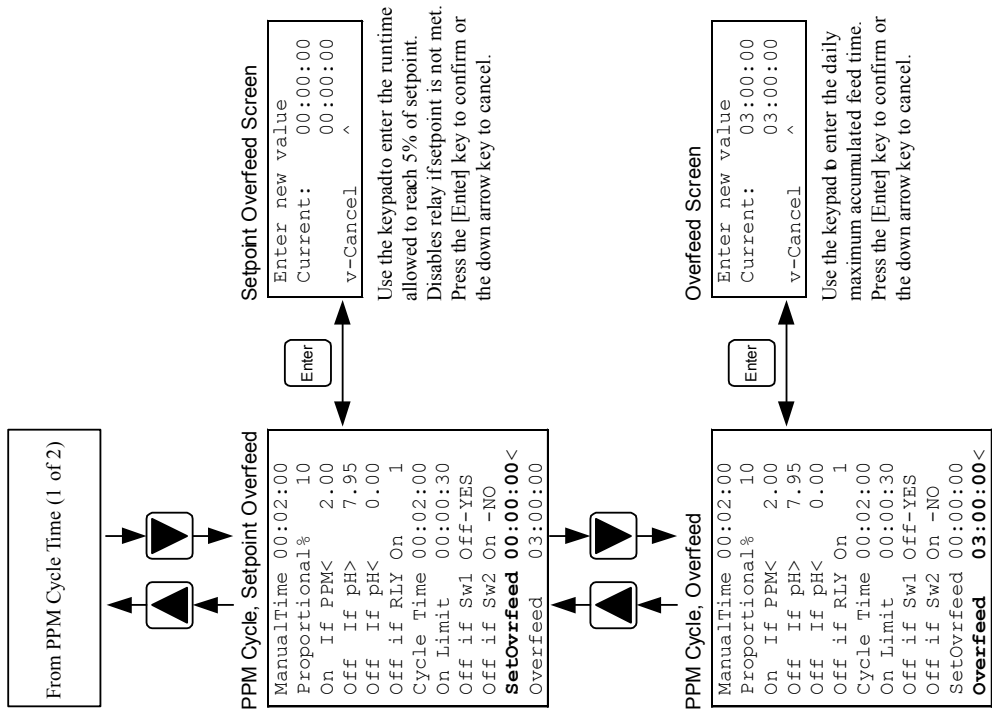



# AK110 Programming Screen Navigation, PPM Mix Time (1 of 2)

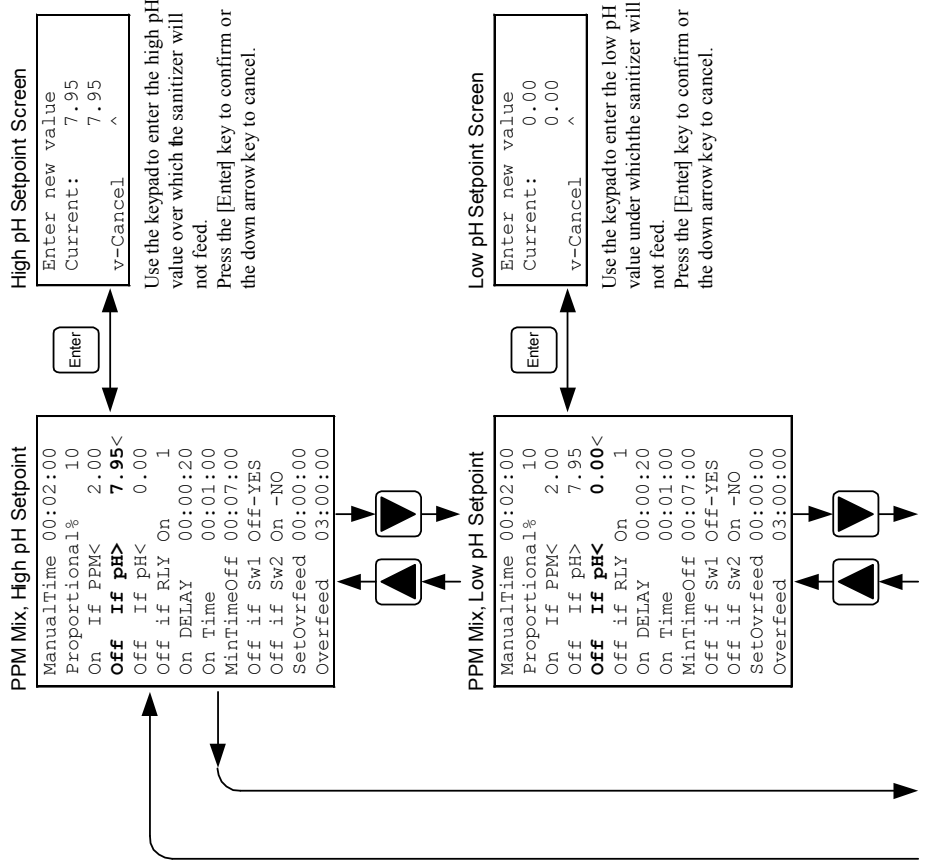
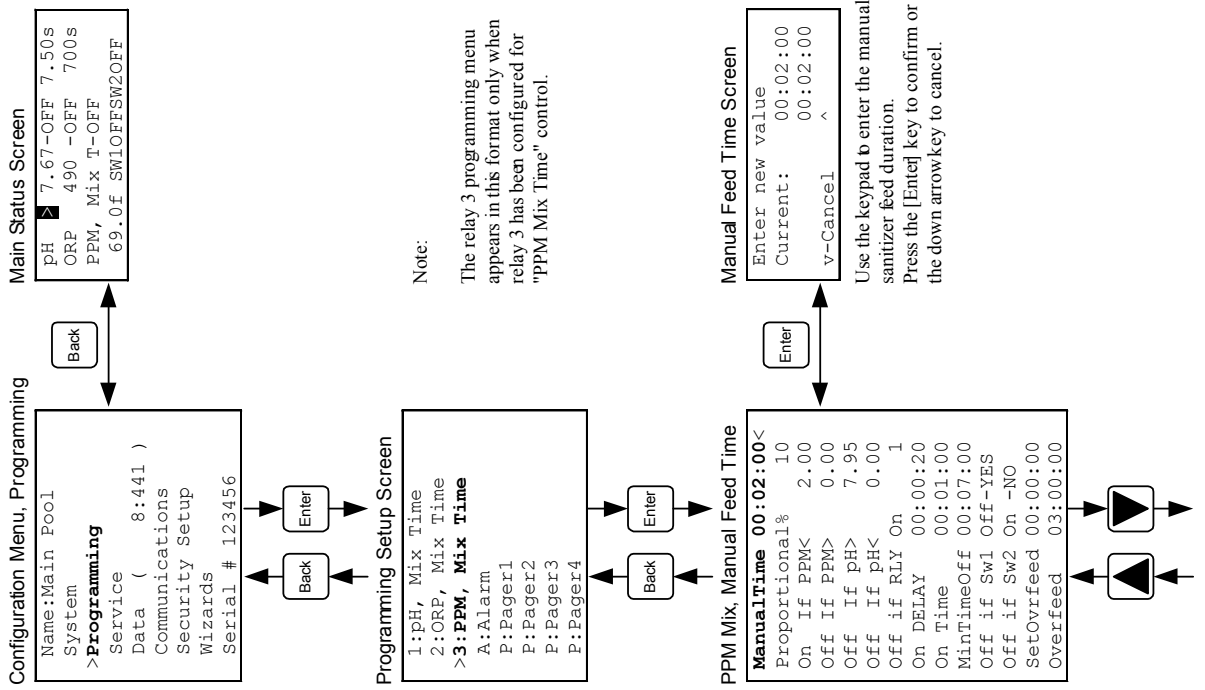

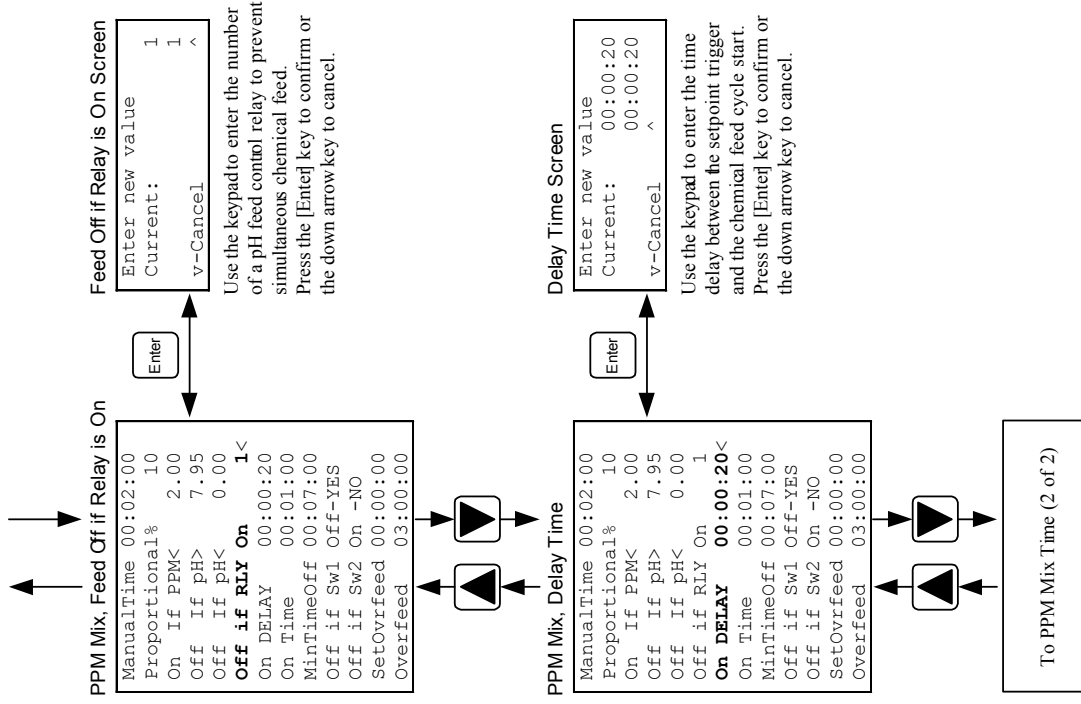
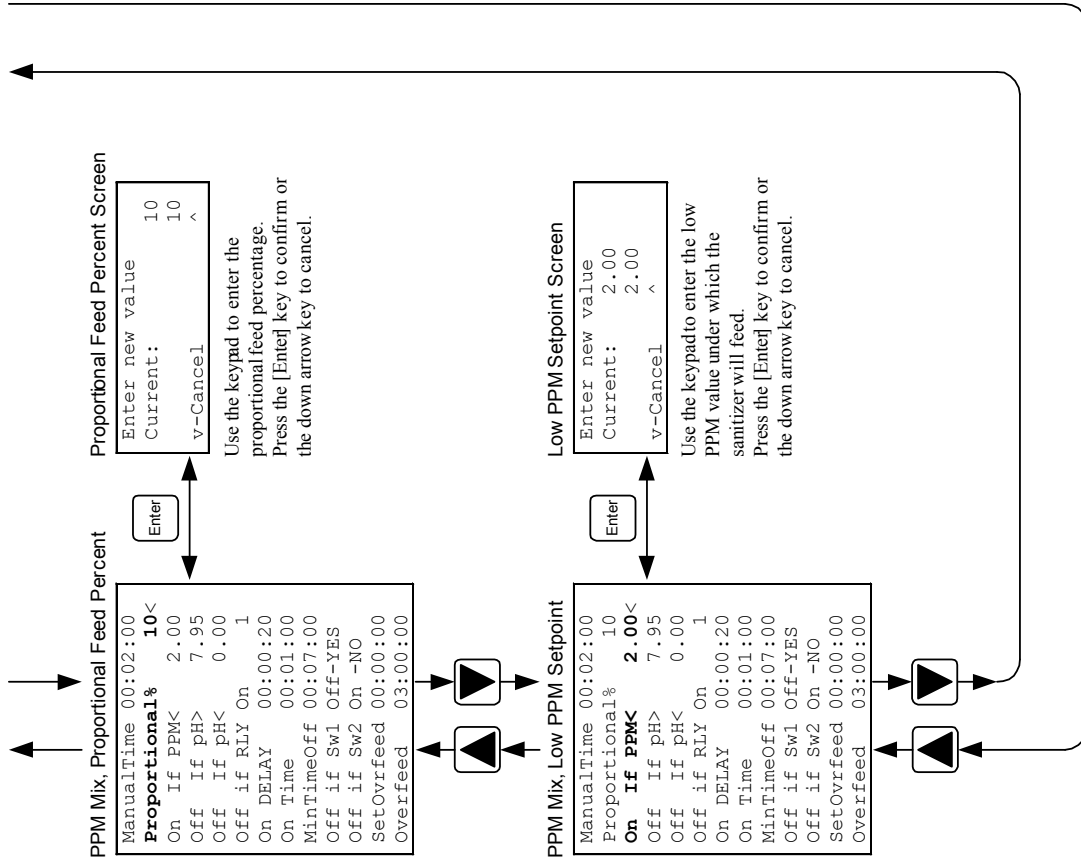

# AK110 Programming Screen Navigation, PPM Mix Time (2 of 2)

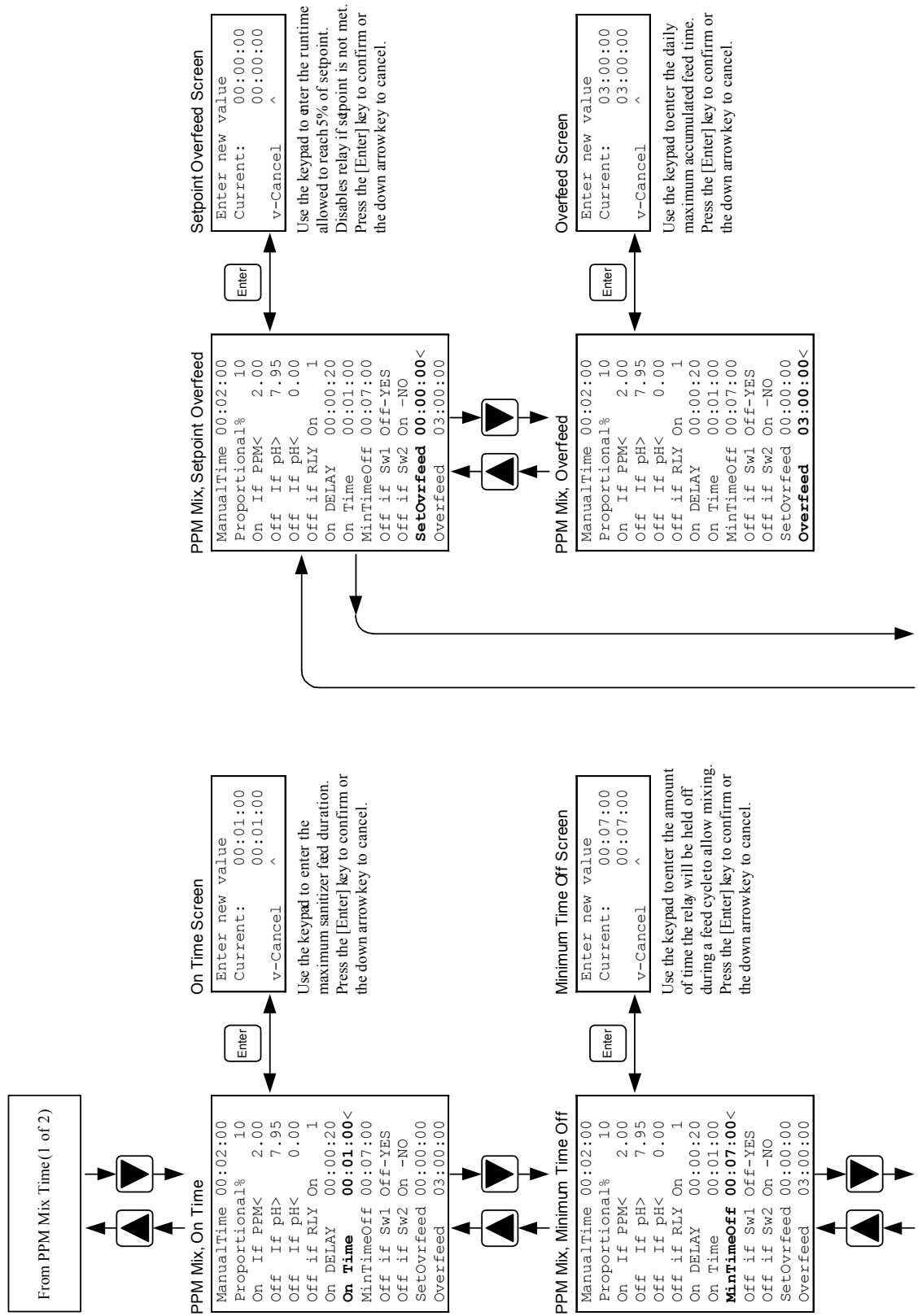



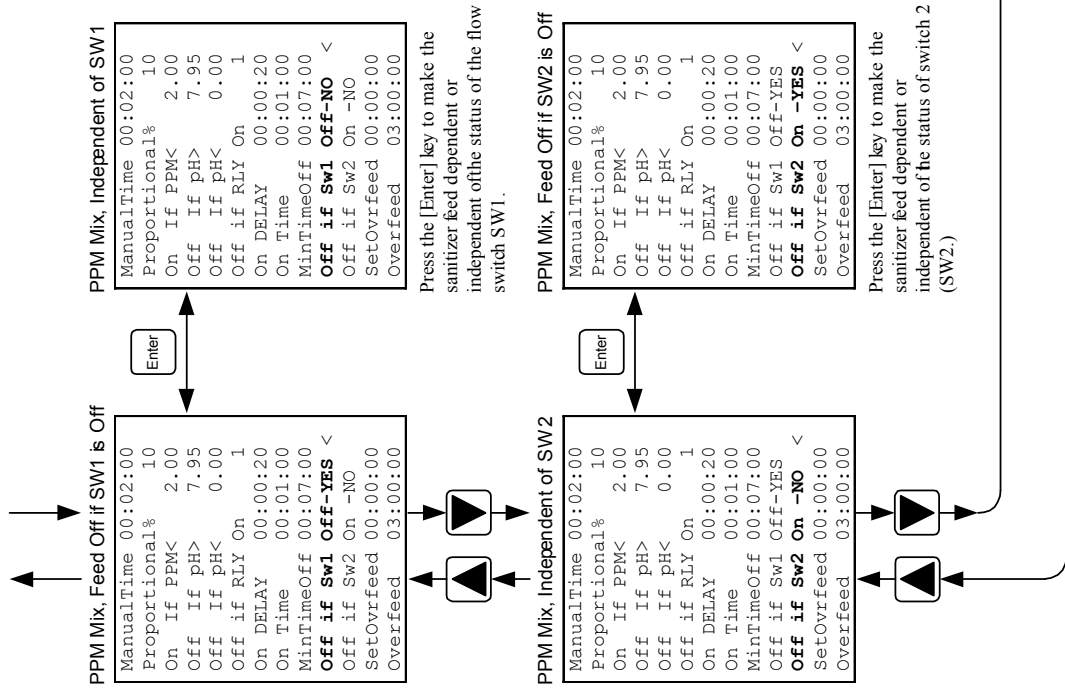

# AK110 Programming Screen Navigation, Probe Clean

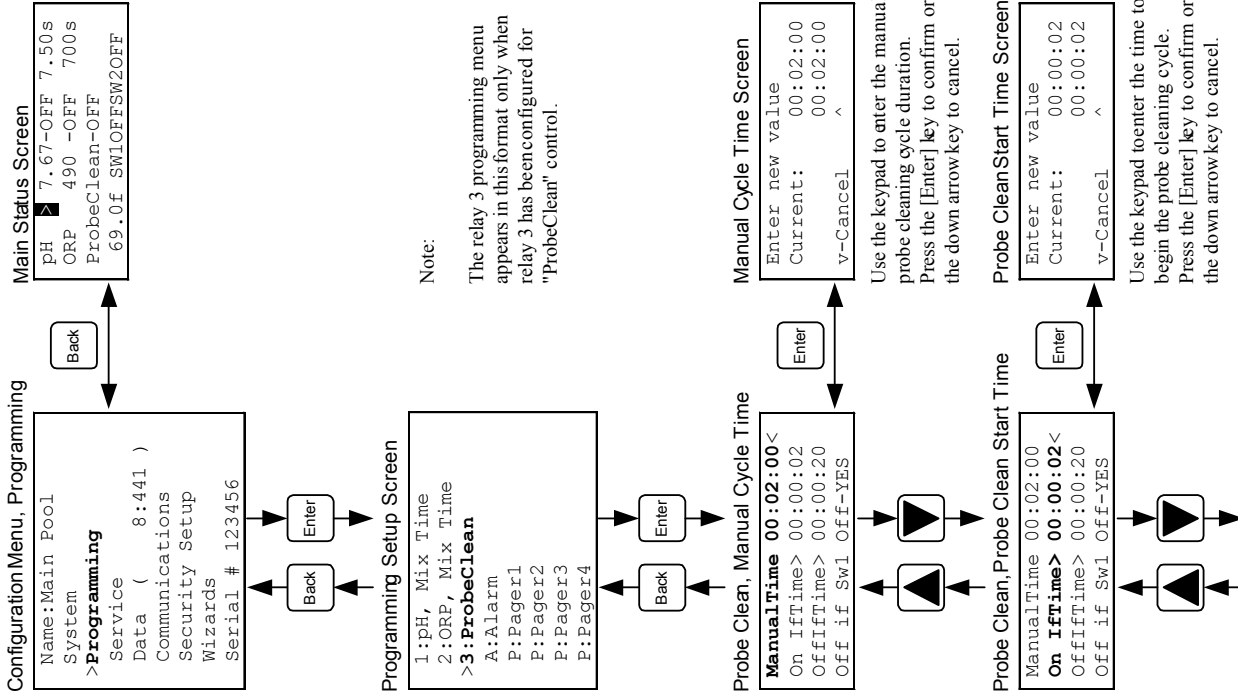

Note:

The relay 3 programming menu appears in this format only when relay 3 has been configured for "ProbeClean" control.

Use the keypad to enter the manual probe cleaning cycle duration. Press the [Enter] key to confirm or the down arrowkey to cancel.

Use the keypad to enter the time to begin the probe cleaning cycle. Press the [Enter] key to confirm or the down arrowkey to cancel.

Probe Clean, Probe Clean Stop Time

```
ManualTime 00:02:00
On IfTime> 00:00:02
OffIfTime> 00:00:20<
Off if Sw1 Off-YES
```

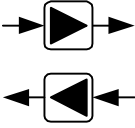

Use the keypad to enter the time to end the probe cleaning cycle. Press the [Enter] key to confirm or the down arrow key to cancel.

```
Enter new value
Current: 00:00:20
00:00:20
v-Cancel ^
```

Enter

Probe Clean, Off if SW1 is Off

```
ManualTime 00:02:00
On IfTime> 00:00:02
OffIfTime> 00:00:20
Off if Sw1 Off-YES <
```

Probe Clean, independent of SW 1

```
ManualTime 00:02:00
On IfTime> 00:00:02
OffIfTime> 00:00:20
Off if Sw1 Off-NO <
```

Enter

Press the [Enter] key to make the probe cleaning cycle dependent or independent of the status of the flow switch SW1.

# AK110 Programming Screen Navigation, Heater

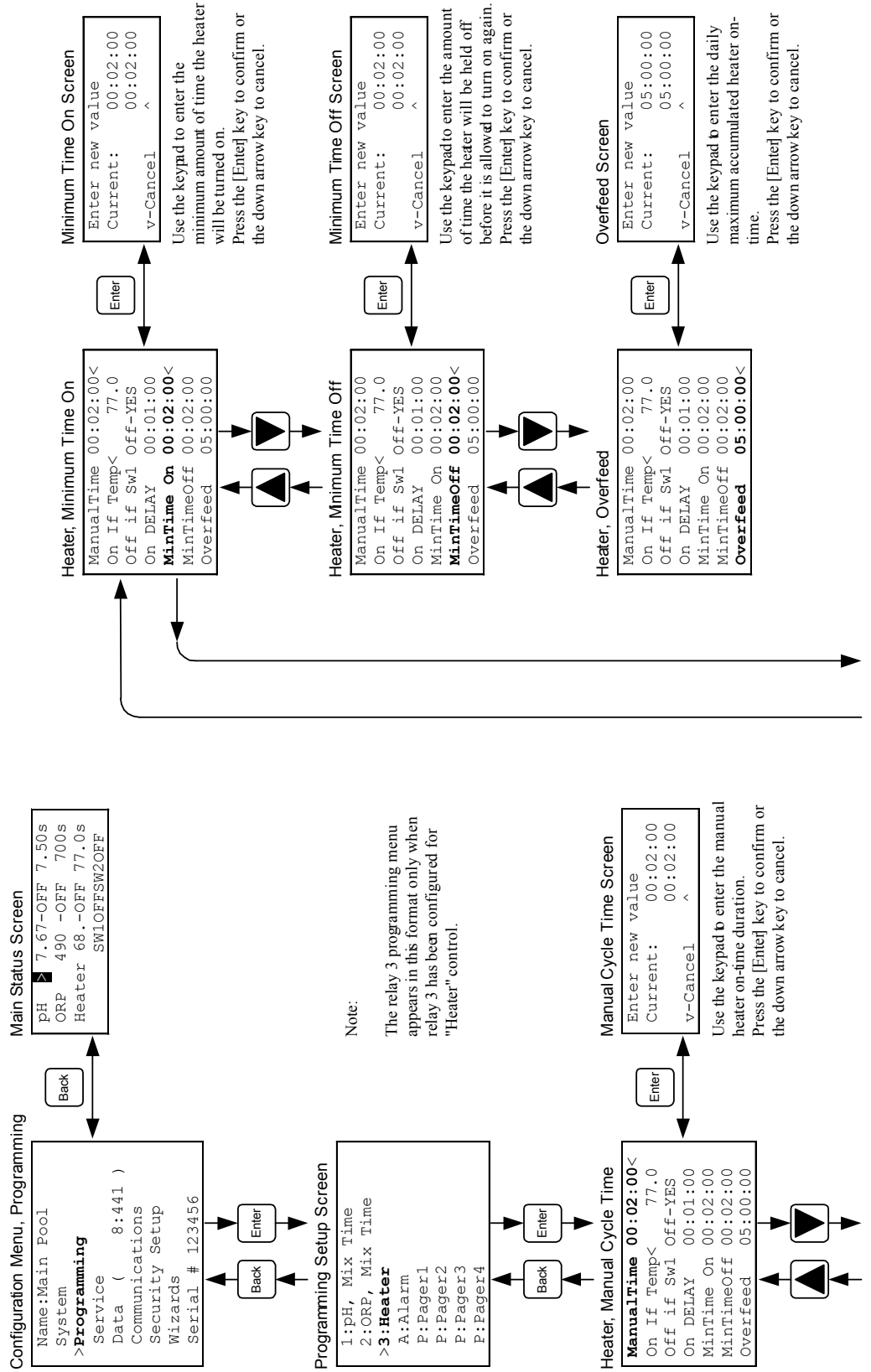

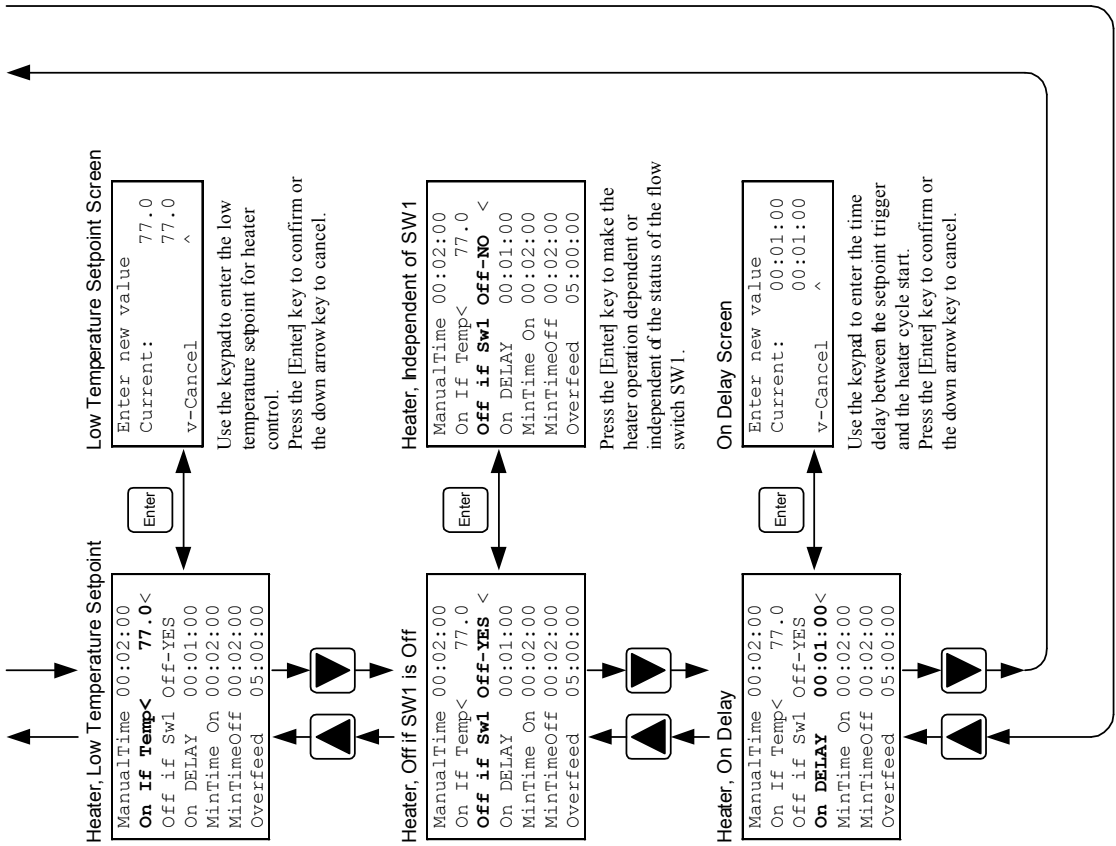

# AK110 Programming Screen Navigation, Alarm Out (1 of 2)

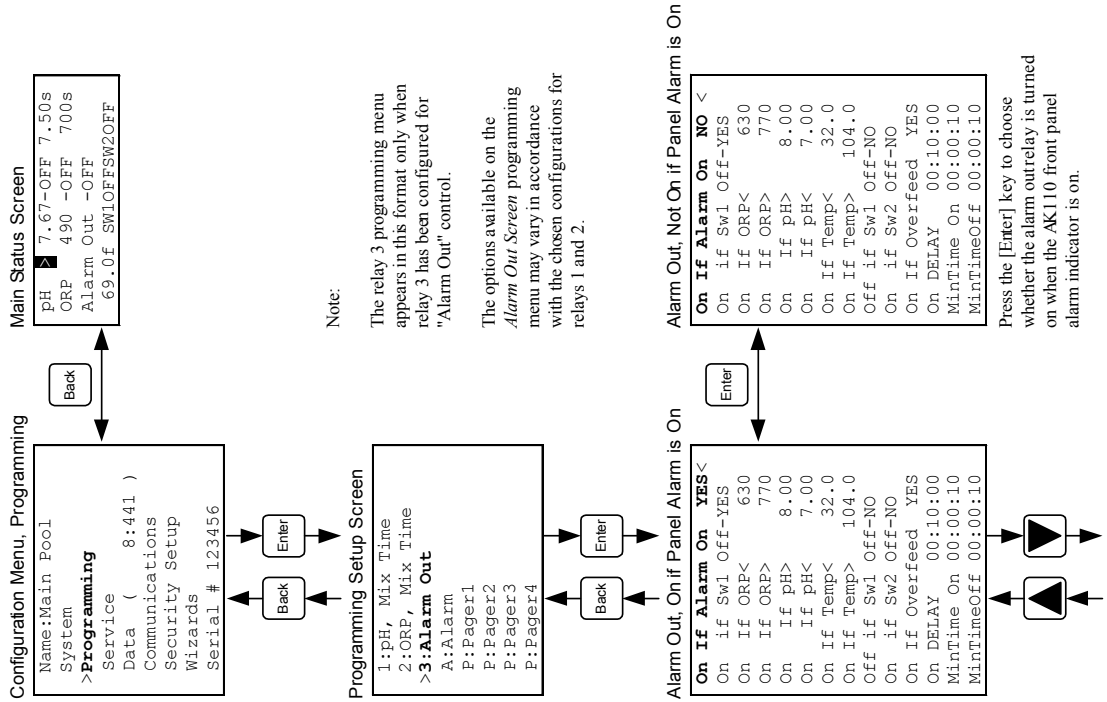

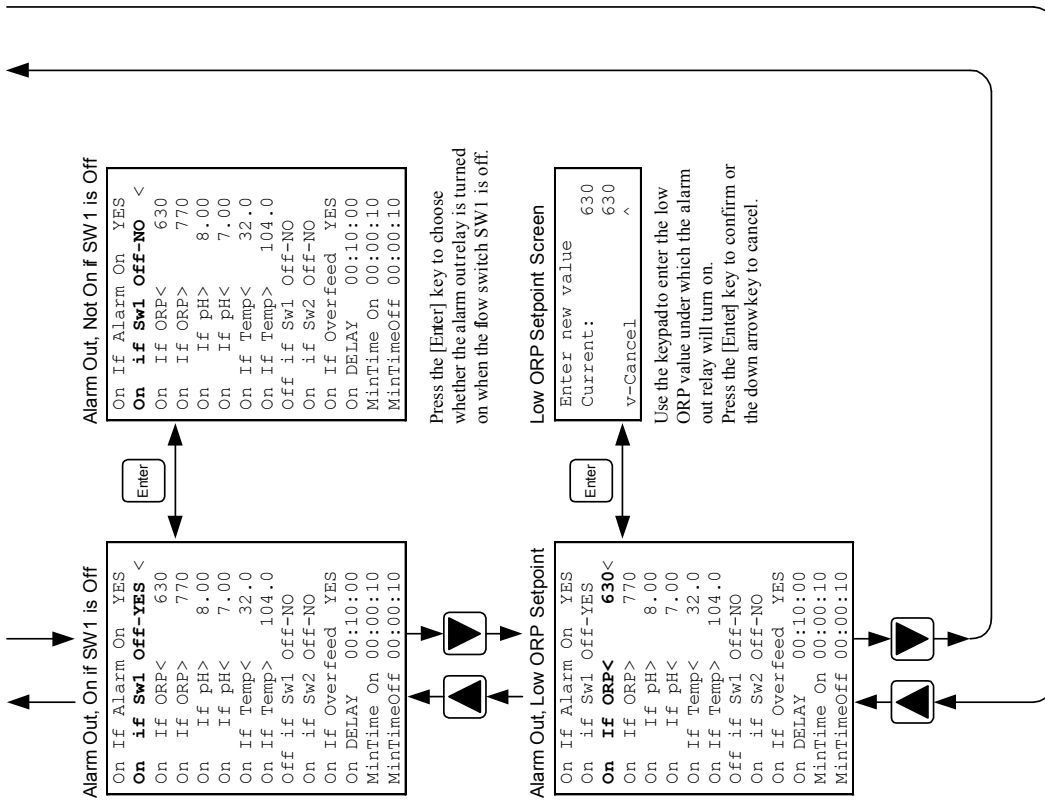

Alarm Out, Not On if SW1 is Off

```

    On If Alarm On YES
    On if Sw1 Off-NO <
    On If ORP< 630
    On If ORP> 770
    On If pH> 8.00
    On If pH< 7.00
    On If Temp< 32.0
    On If Temp> 104.0
    Off If Sw1 Off-NO
    On If Sw2 Off-NO
    On If Overfeed YES
    On DELAY 00:10:00
    MinTime On 00:00:10
    MinTimeOff 00:00:10
  
```

Press the [Enter] key to choose whether the alarm outrelay is turned on when the flow switch SW1 is off.

Low ORP Setpoint

```

    Enter new value
    Current: 630
    v-Cancel ^
  
```

Low ORP Setpoint Screen

```

    On If Alarm On YES
    On if Sw1 Off-YES <
    On If ORP< 630
    On If ORP> 770
    On If pH> 8.00
    On If pH< 7.00
    On If Temp< 32.0
    On If Temp> 104.0
    Off If Sw1 Off-NO
    On If Sw2 Off-NO
    On If Overfeed YES
    On DELAY 00:10:00
    MinTime On 00:00:10
    MinTimeOff 00:00:10
  
```

Alarm Out, On if SW1 is Off

```

    On If Alarm On YES
    On if SW1 Off-YES <
    On If ORP< 630
    On If ORP> 770
    On If pH> 8.00
    On If pH< 7.00
    On If Temp< 32.0
    On If Temp> 104.0
    Off If Sw1 Off-NO
    On If Sw2 Off-NO
    On If Overfeed YES
    On DELAY 00:10:00
    MinTime On 00:00:10
    MinTimeOff 00:00:10
  
```

Alarm Out, Low ORP Setpoint

```

    On If Alarm On YES
    On if Sw1 Off-YES <
    On If ORP< 630<
    On If ORP> 770
    On If pH> 8.00
    On If pH< 7.00
    On If Temp< 32.0
    On If Temp> 104.0
    Off If Sw1 Off-NO
    On If Sw2 Off-NO
    On If Overfeed YES
    On DELAY 00:10:00
    MinTime On 00:00:10
    MinTimeOff 00:00:10
  
```

Low pH Setpoint Screen

```

    Enter new value
    Current: 7.00
    v-Cancel ^
  
```

Low pH Setpoint

```

    On If Alarm On YES
    On if Sw1 Off-YES <
    On If ORP< 630
    On If ORP> 770
    On If pH> 8.00
    On if pH< 7.00<
    On If Temp< 32.0
    On If Temp> 104.0
    Off If Sw1 Off-NO
    On If Sw2 Off-NO
    On If Overfeed YES
    On DELAY 00:10:00
    MinTime On 00:00:10
    MinTimeOff 00:00:10
  
```

Low Temperature Setpoint Screen

```

    Enter new value
    Current: 32.0
    v-Cancel ^
  
```

Low Temperature Setpoint

```

    On If Alarm On YES
    On if Sw1 Off-YES <
    On If ORP< 630
    On If ORP> 770
    On If pH> 8.00
    On If pH< 7.00
    On If Temp< 32.0<
    On If Temp> 104.0
    Off If Sw1 Off-NO
    On If Sw2 Off-NO
    On If Overfeed YES
    On DELAY 00:10:00
    MinTime On 00:00:10
    MinTimeOff 00:00:10
  
```

To Alarm Out (2 of 2)

# AK110 Programming Screen Navigation, Alarm Out (2 of 2)

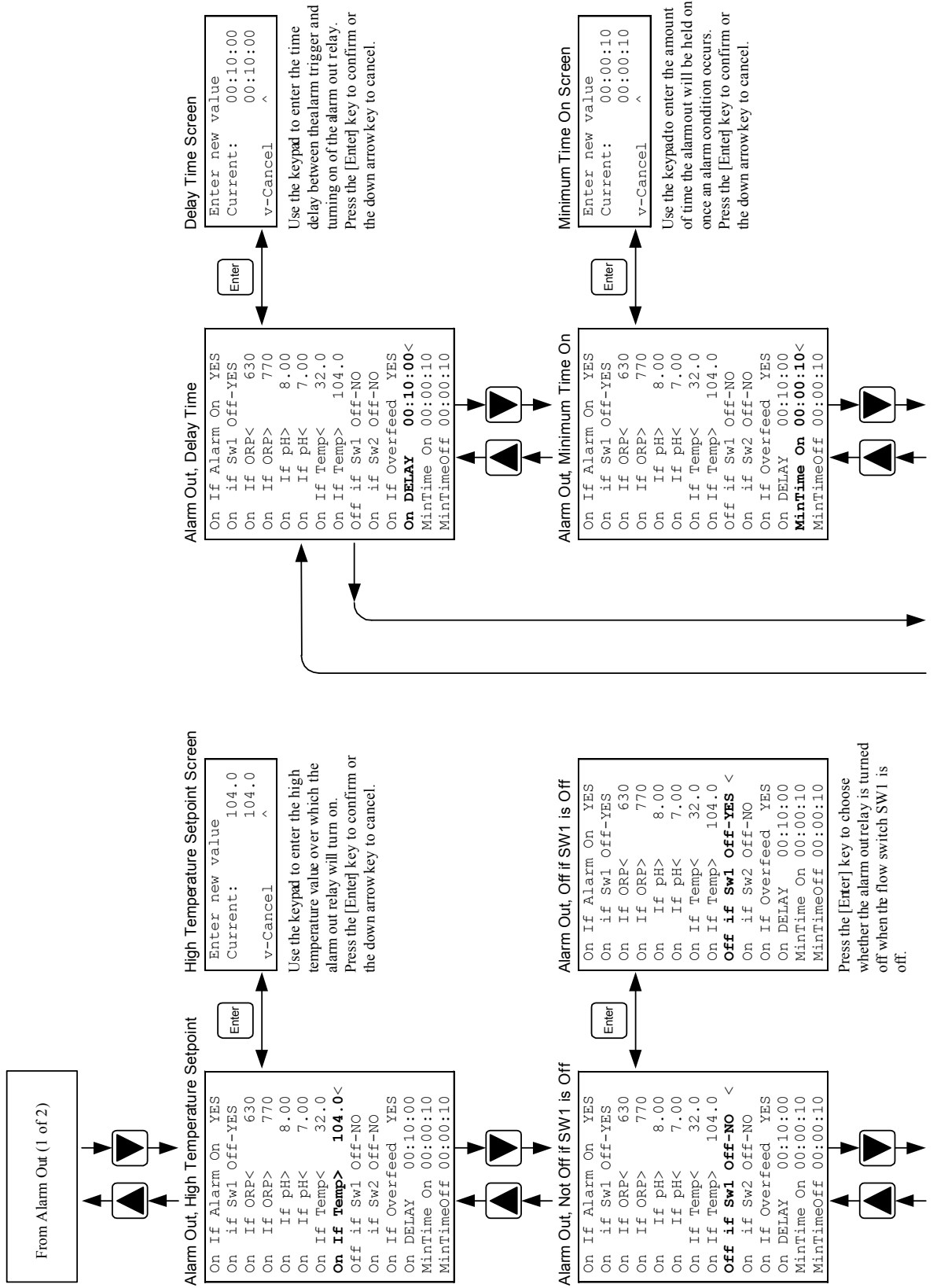



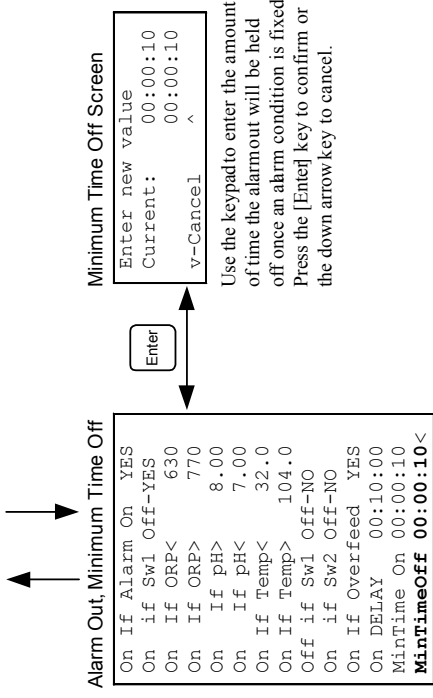
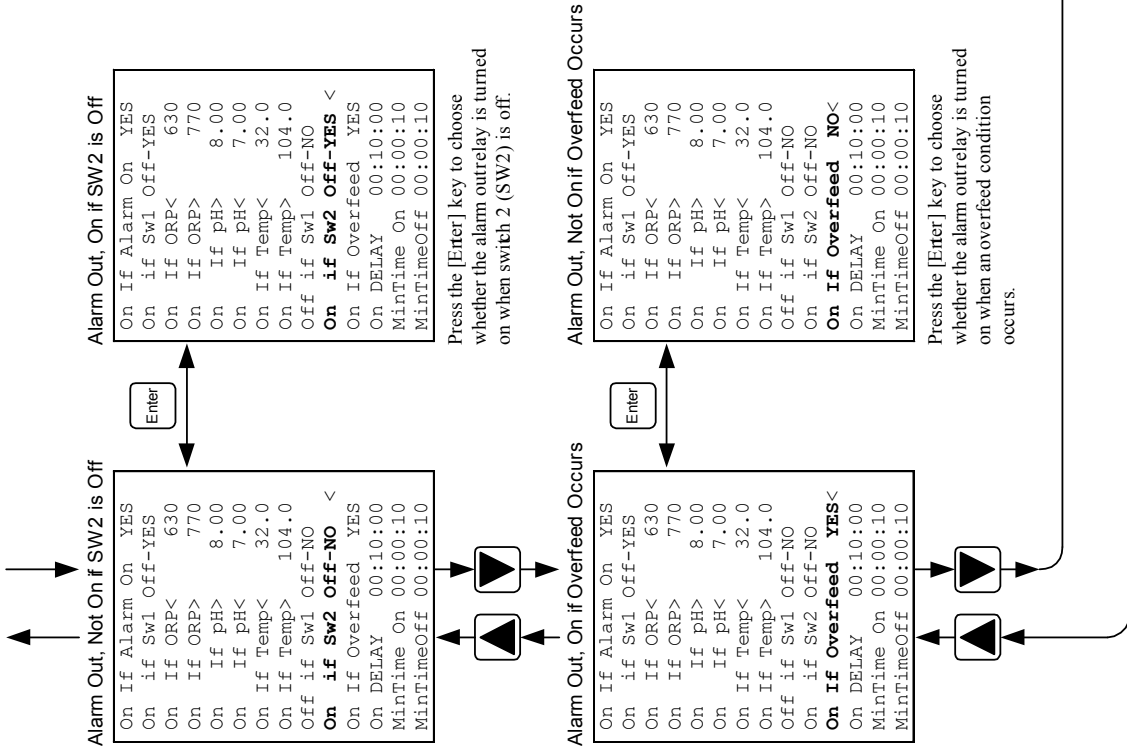

# AK110 Programming Screen Navigation, Aux: Make-Up (Auto Fill)

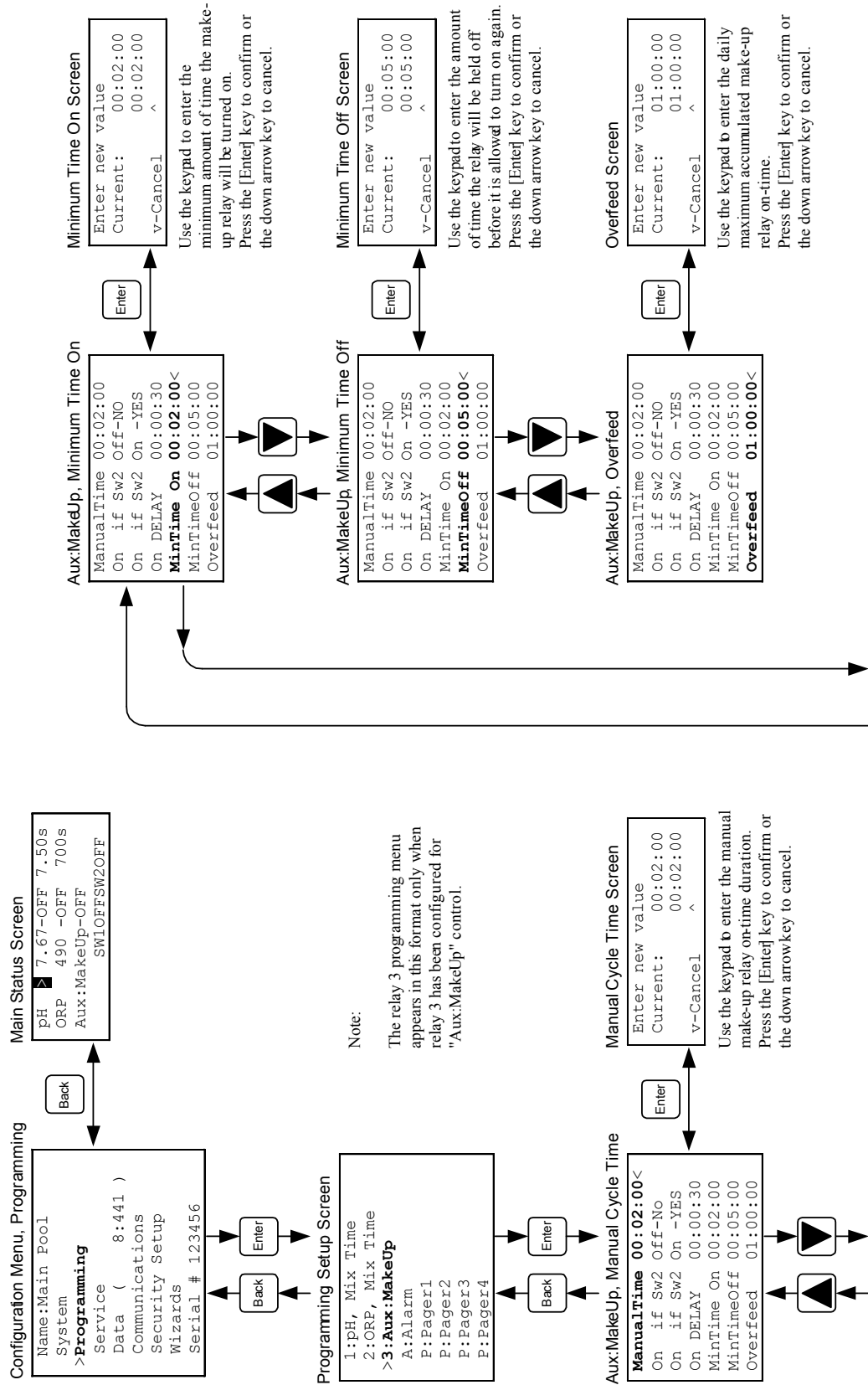

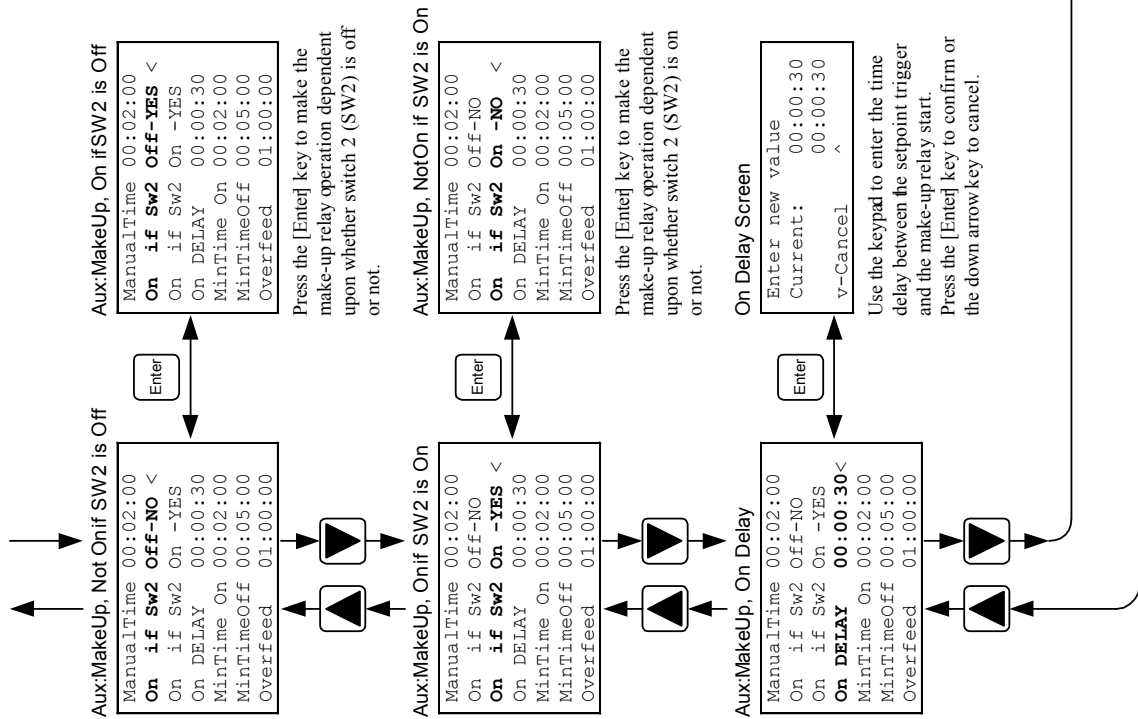

# AK110 Programming Screen Navigation, Daily Event

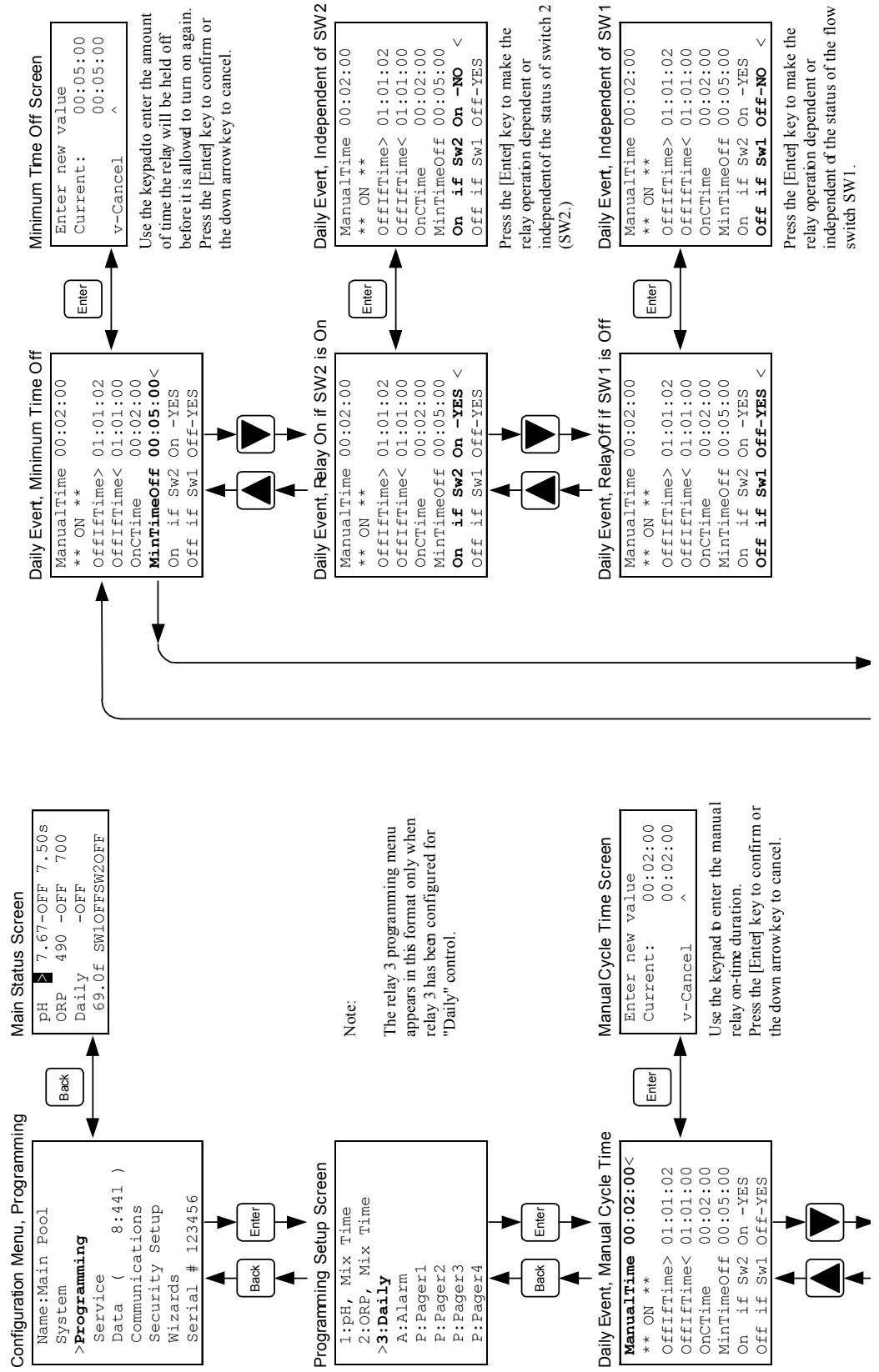

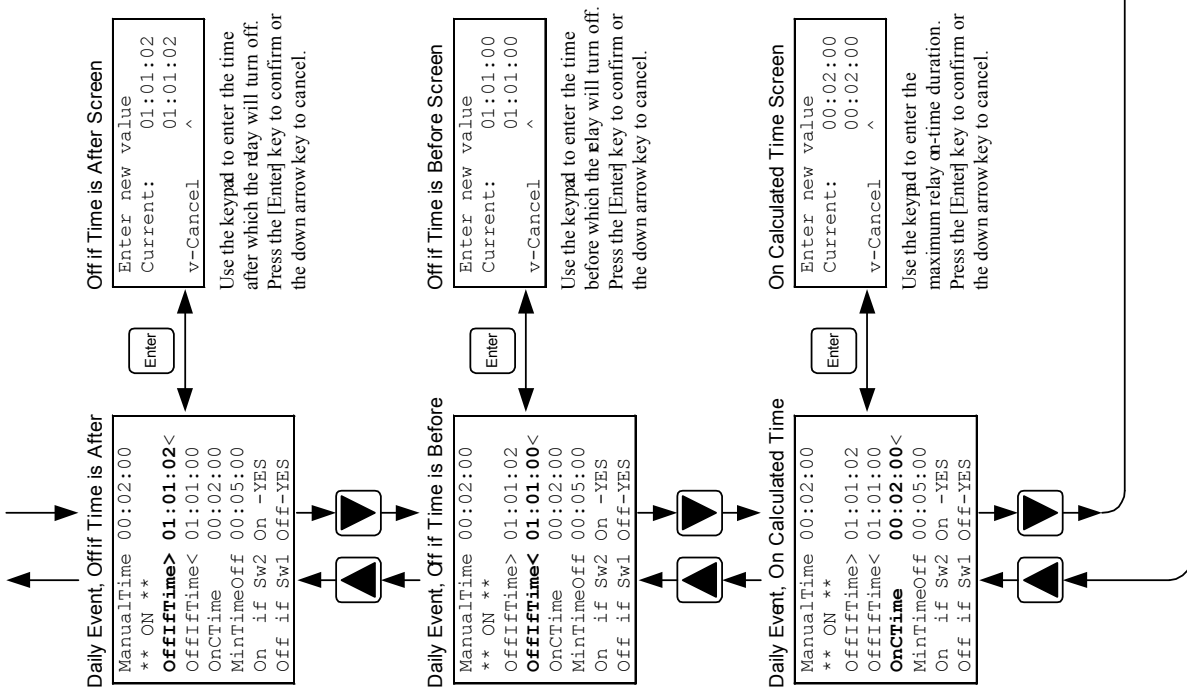

# AK110 Programming Screen Navigation, Weekly Events

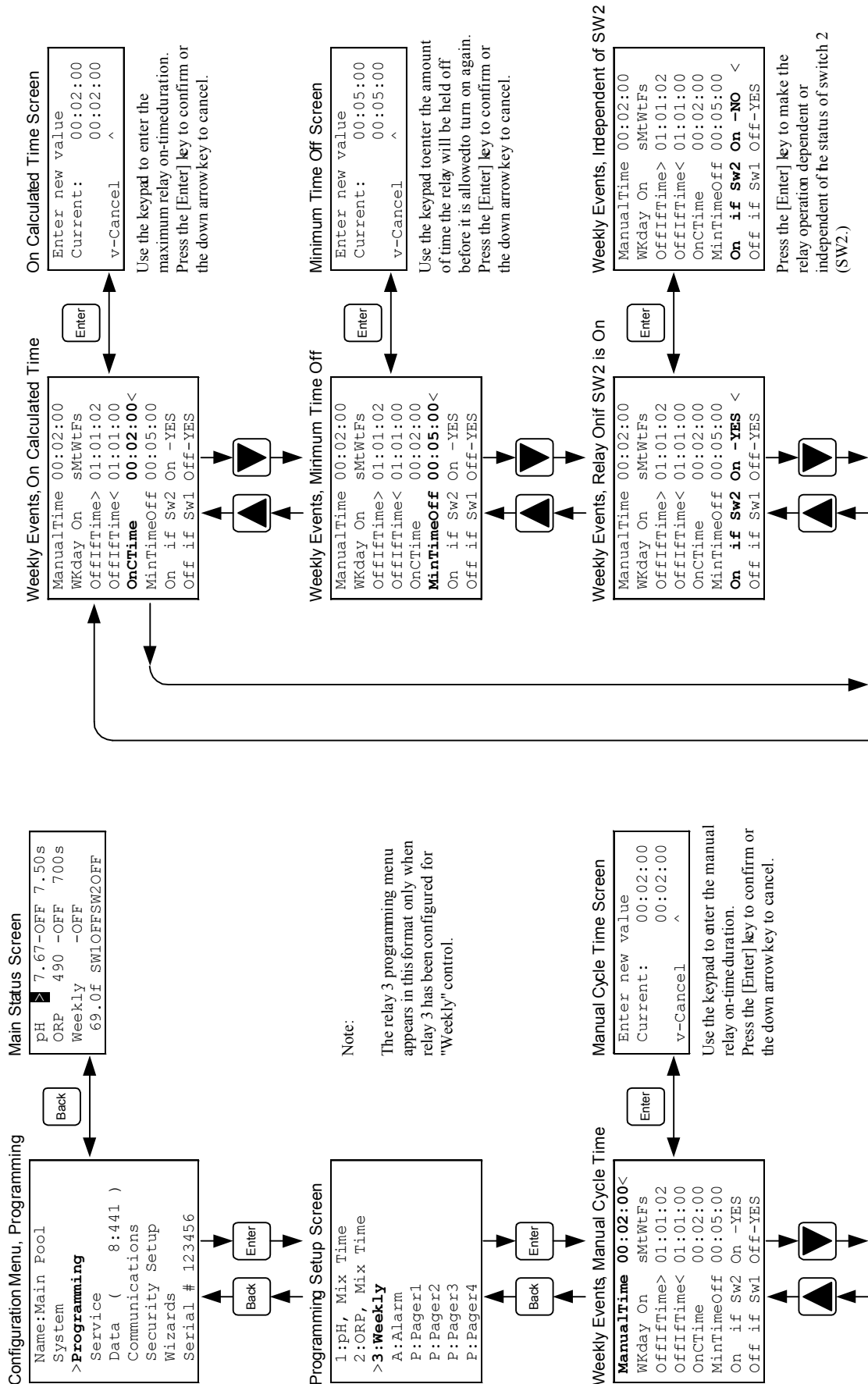

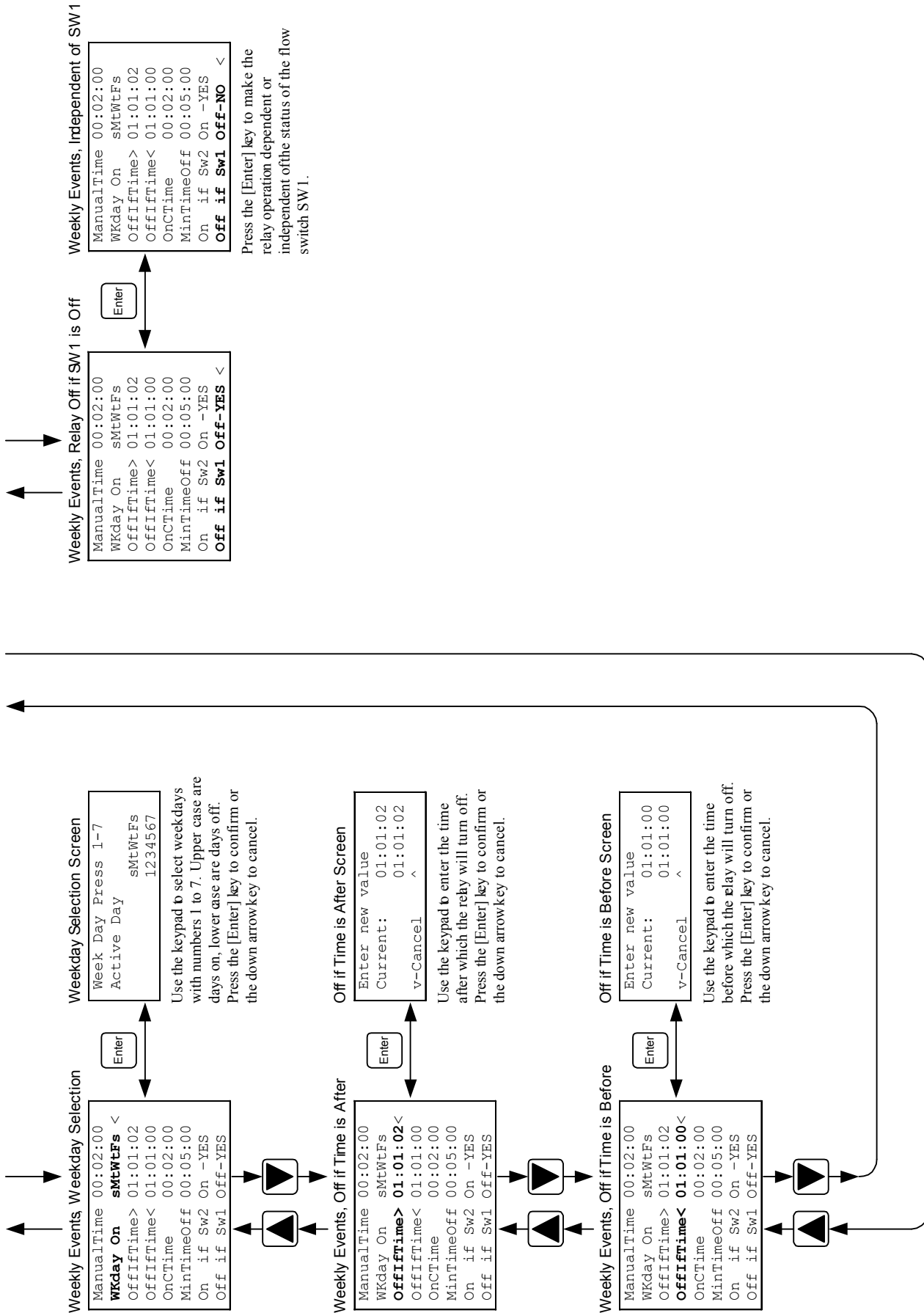

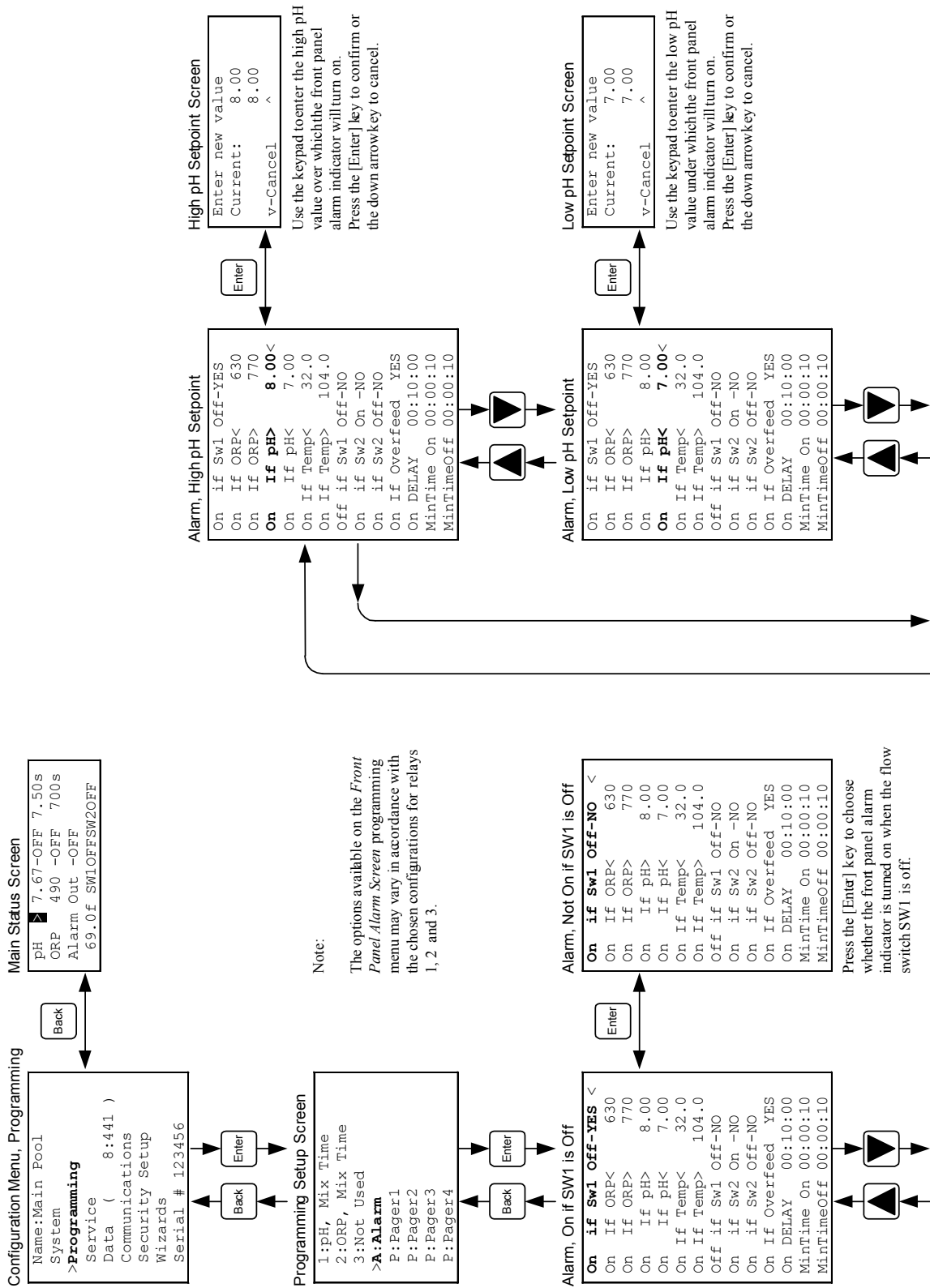



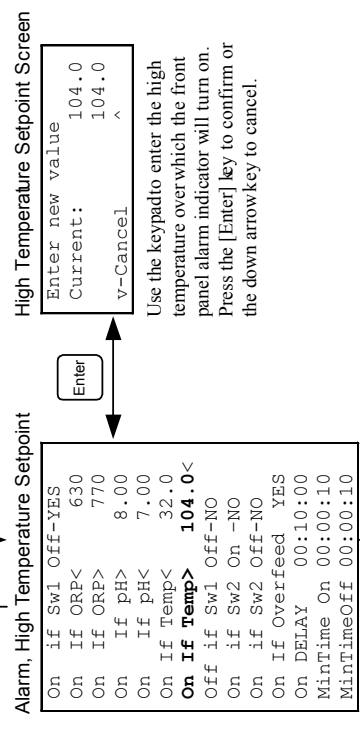
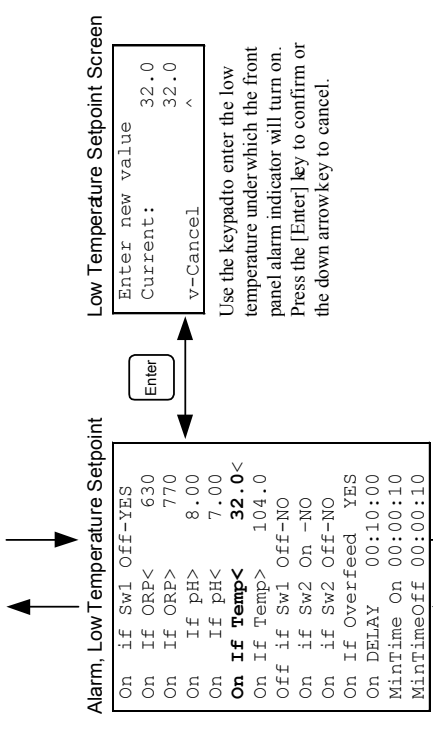
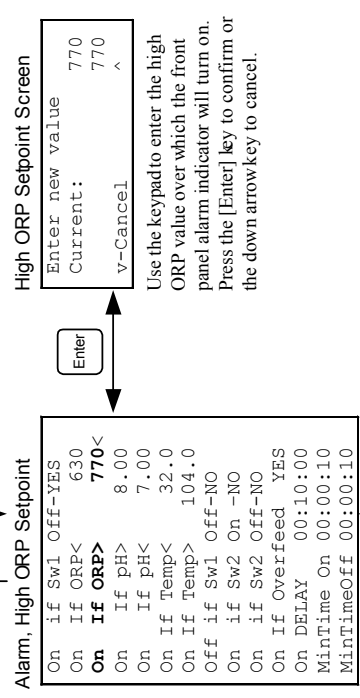
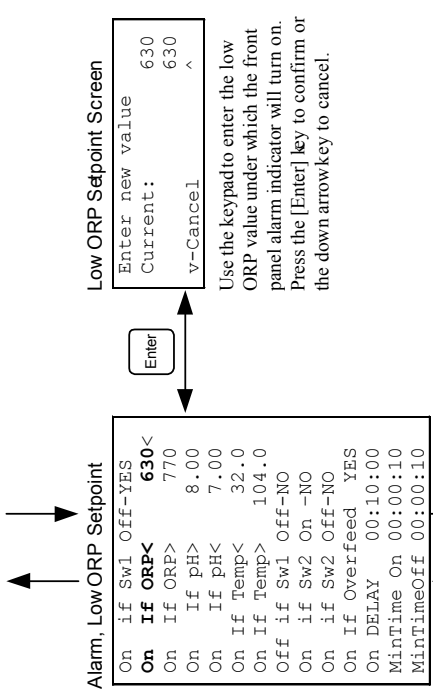

To Front Panel Alarm(2 of 2)

# AK110 Programming Screen Navigation, Front Panel Alarm (2 of 2)

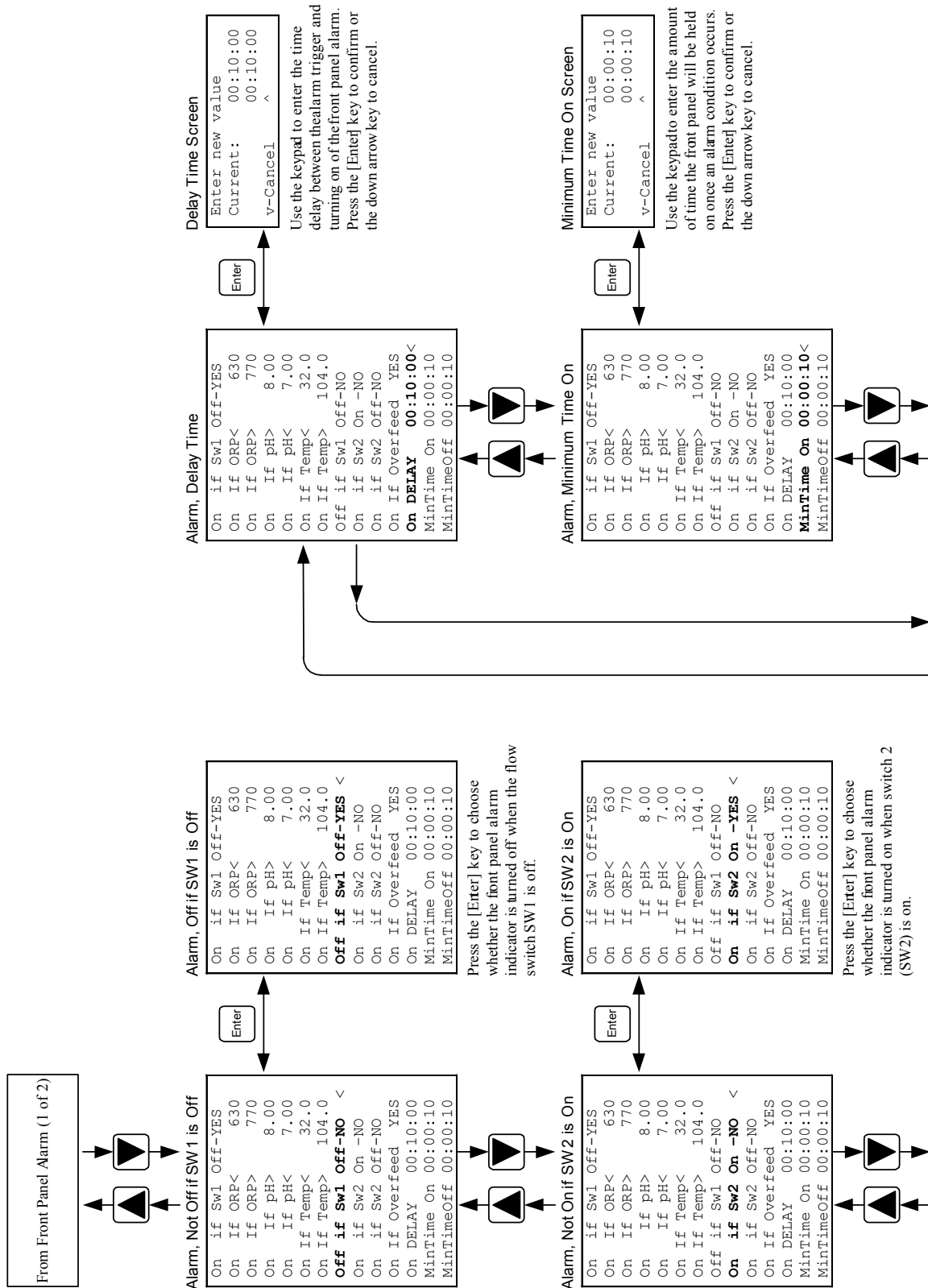

```

Alarm, Not On if SW2 is Off
On If Sw1 Off-YES
On If ORP< 630
On If ORP> 770
On If pH> 8.00
On If pH< 7.00
On If Temp< 32.0
On If Temp> 104.0
Off If Sw1 Off-NO
On If Sw2 On -NO
On If Sw2 Off-NO <
On If Overfeed YES
On DELAY 00:10:00
MinTime On 00:00:10
MinTimeOff 00:00:10

```

Enter

```

Alarm, On if SW2 is Off
On If Sw1 Off-YES
On If ORP< 630
On If ORP> 770
On If pH> 8.00
On If pH< 7.00
On If Temp< 32.0
On If Temp> 104.0
Off If Sw1 Off-NO
On If Sw2 On -NO
On If Sw2 Off-YES <
On If Overfeed YES
On DELAY 00:10:00
MinTime On 00:00:10
MinTimeOff 00:00:10

```

Press the [Enter] key to choose whether the front panel alarm indicator is turned on when switch 2 (SW2) is off.

```

Alarm, On if Overfeed Occurs
On If Sw1 Off-YES
On If ORP< 630
On If ORP> 770
On If pH> 8.00
On If pH< 7.00
On If Temp< 32.0
On If Temp> 104.0
Off If Sw1 Off-NO
On If Sw2 On -NO
On If Overfeed YES<
On DELAY 00:10:00
MinTime On 00:00:10
MinTimeOff 00:00:10

```

Enter

```

Alarm, Not On if Overfeed Occurs
On If Sw1 Off-YES
On If ORP< 630
On If ORP> 770
On If pH> 8.00
On If pH< 7.00
On If Temp< 32.0
On If Temp> 104.0
Off If Sw1 Off-NO
On If Sw2 On -NO
On If Overfeed NO<
On DELAY 00:10:00
MinTime On 00:00:10
MinTimeOff 00:00:10

```

Press the [Enter] key to choose whether the front panel alarm indicator is turned on when an overfeed condition occurs.

```

Alarm, Minimum Time Off
On If Sw1 Off-YES
On If ORP< 630
On If ORP> 770
On If pH> 8.00
On If pH< 7.00
On If Temp< 32.0
On If Temp> 104.0
Off If Sw1 Off-NO
On If Sw2 On -NO
On If Sw2 Off-NO
On If Overfeed YES
On DELAY 00:10:00
MinTime On 00:00:10
MinTimeOff 00:00:10<

```

Enter

```

Minimum Time Off Screen
Enter new value
Current: 00:00:10
v-Cancel ^

```

Use the keypad to enter the amount of time the alarm will be held off once an alarm condition is fixed. Press the [Enter] key to confirm or the down arrow key to cancel.

# AK110 Programming Screen Navigation, Pager 1 (1 of 2)

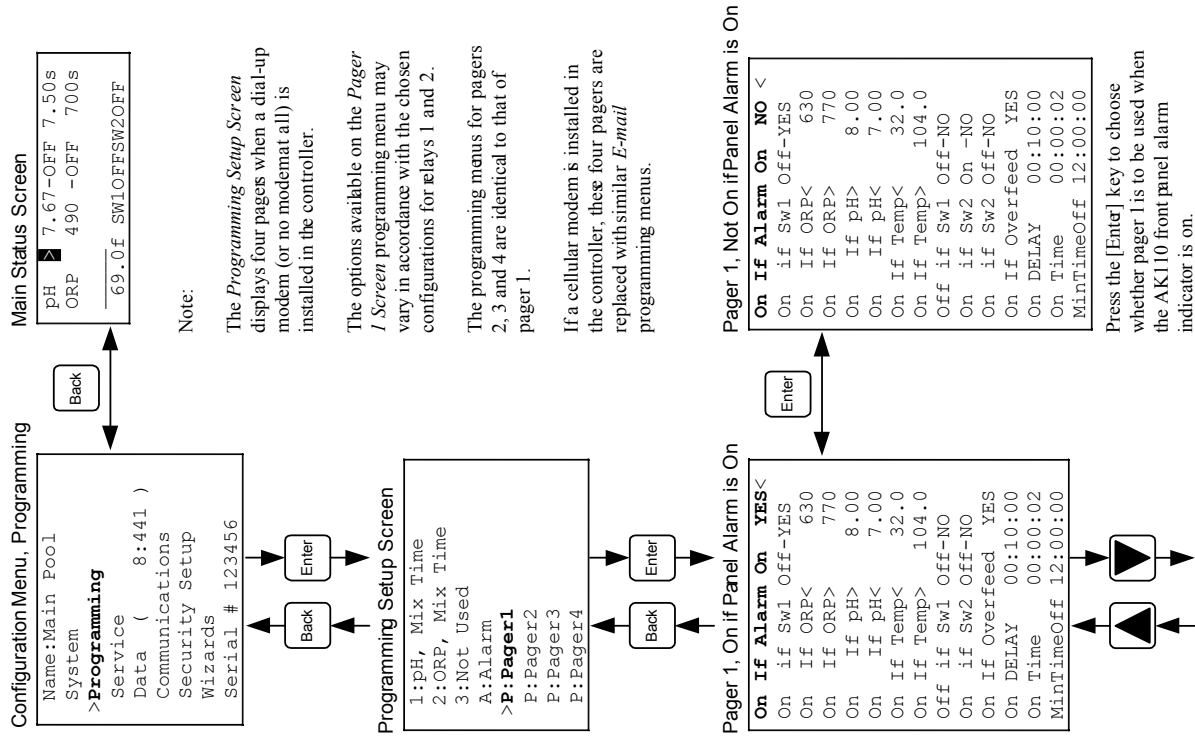

Note:

The *Programming Setup Screen* displays four pages when a dial-up modem (or no modem at all) is installed in the controller.

The options available on the *Pager / Screen* programming menu may vary in accordance with the chosen configurations for relays 1 and 2.

The programming menus for pagers 2, 3 and 4 are identical to that of pager 1.

If a cellular modem is installed in the controller, these four pagers are replaced with similar *E-mail* programming menus.

Press the [Enter] key to choose whether pager 1 is to be used when the AK110 front panel alarm indicator is on.

Use the keypad to enter the high ORP value over which pager 1 is to be activated.  
Press the [Enter] key to confirm or the down arrowkey to cancel.

Use the keypad to enter the high pH value over which pager 1 is to be activated.  
Press the [Enter] key to confirm or the down arrowkey to cancel.

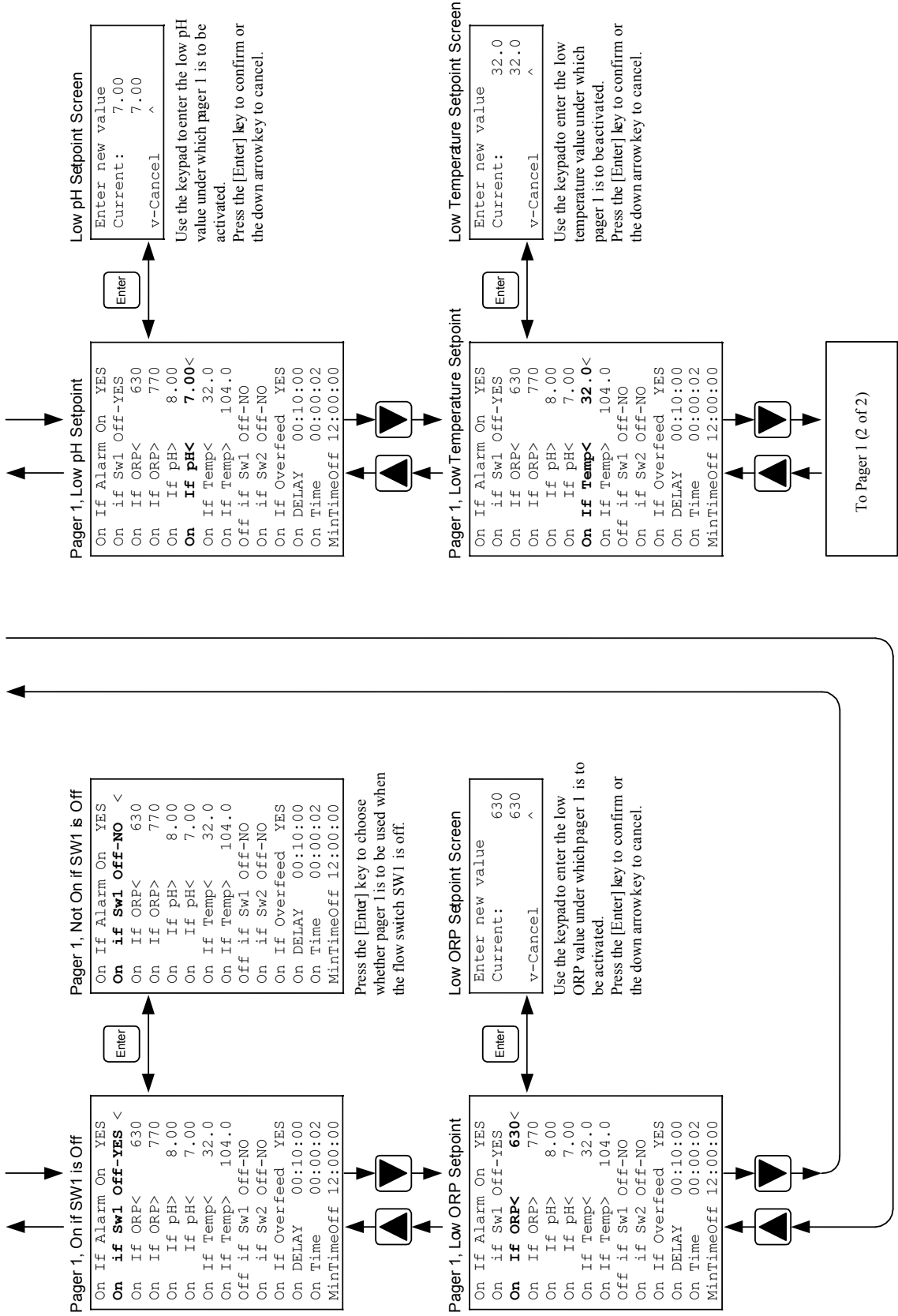

# AK110 Programming Screen Navigation, Pager 1 (2 of 2)

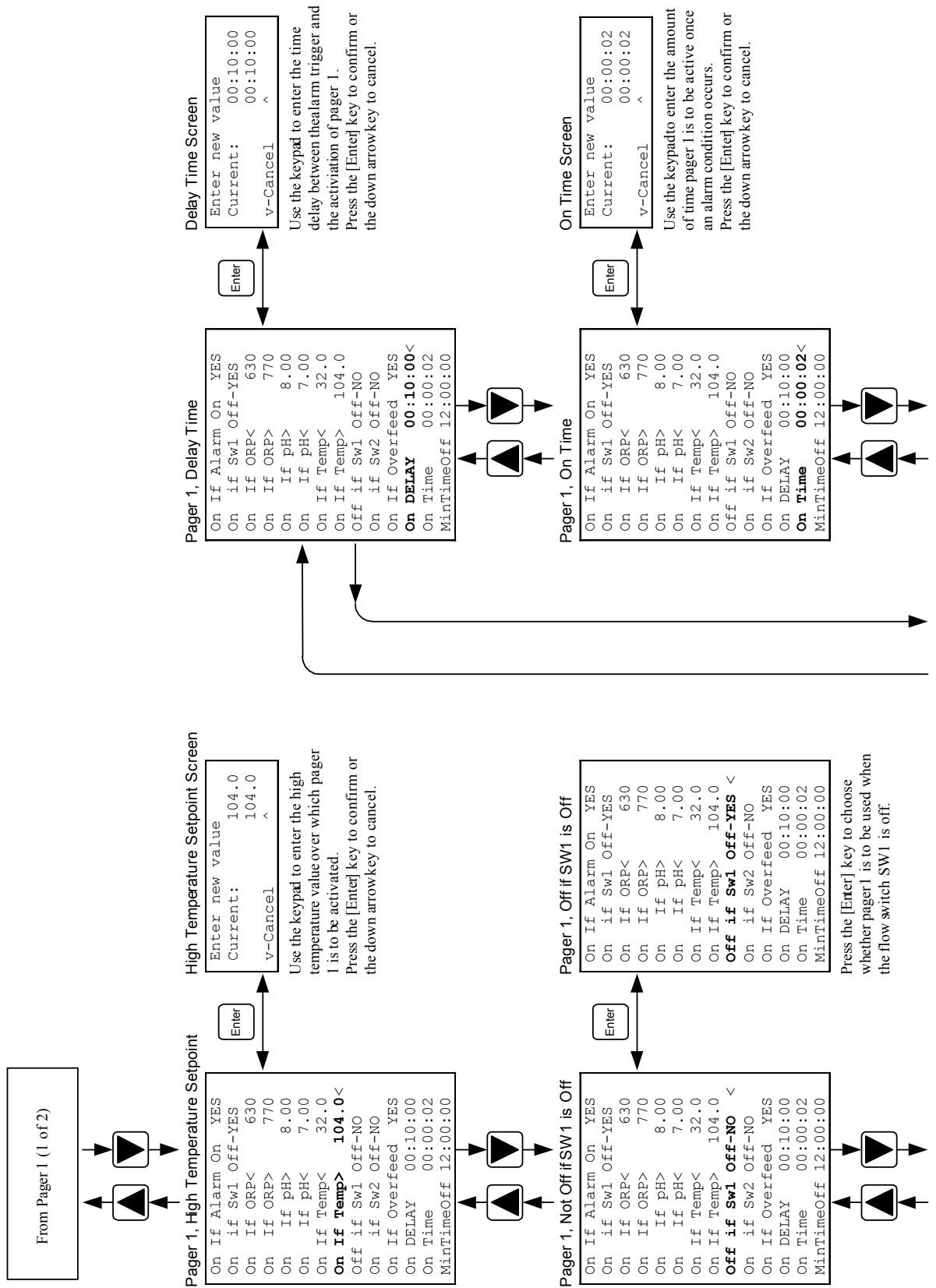

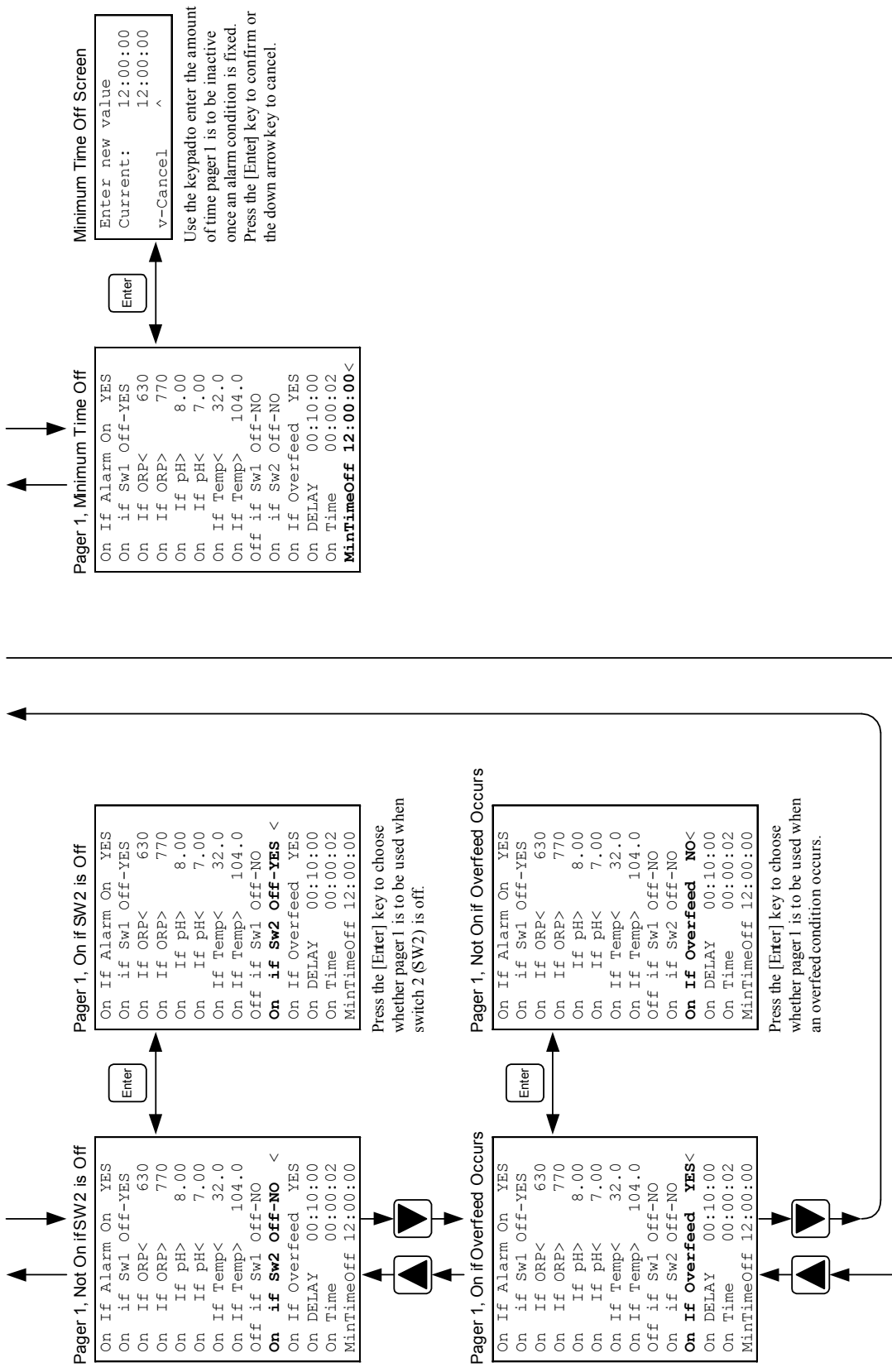

# AK110 Programming Screen Navigation, E-mail 1 (1 of 2)

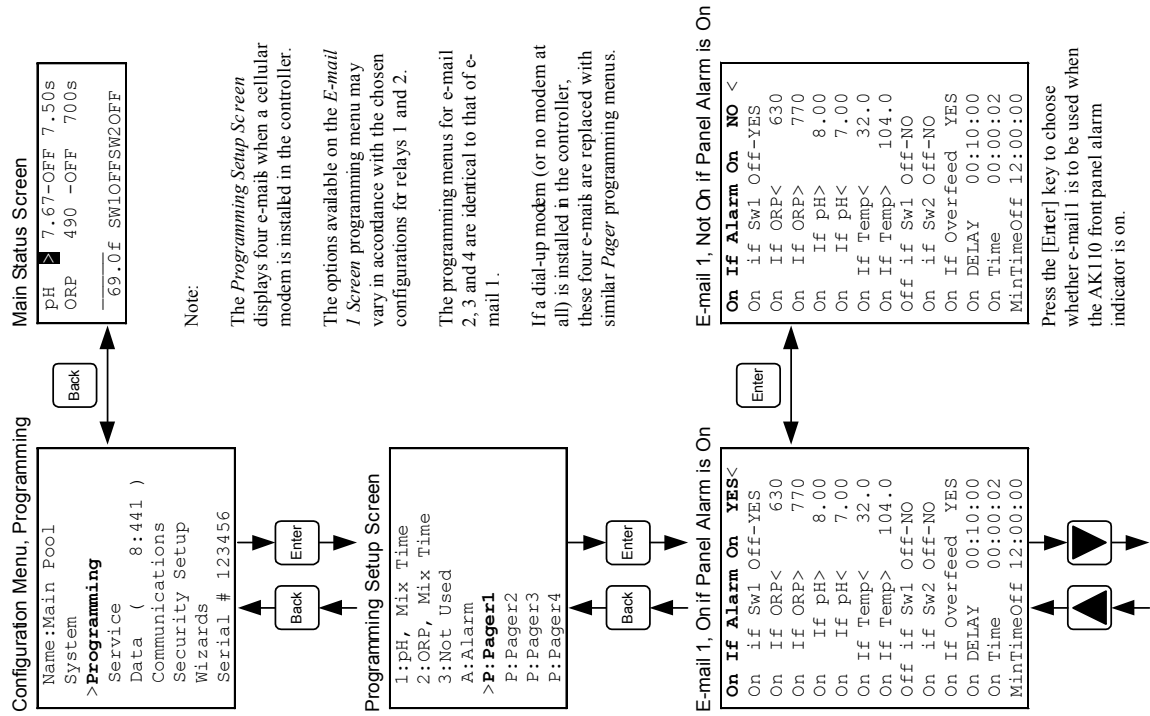



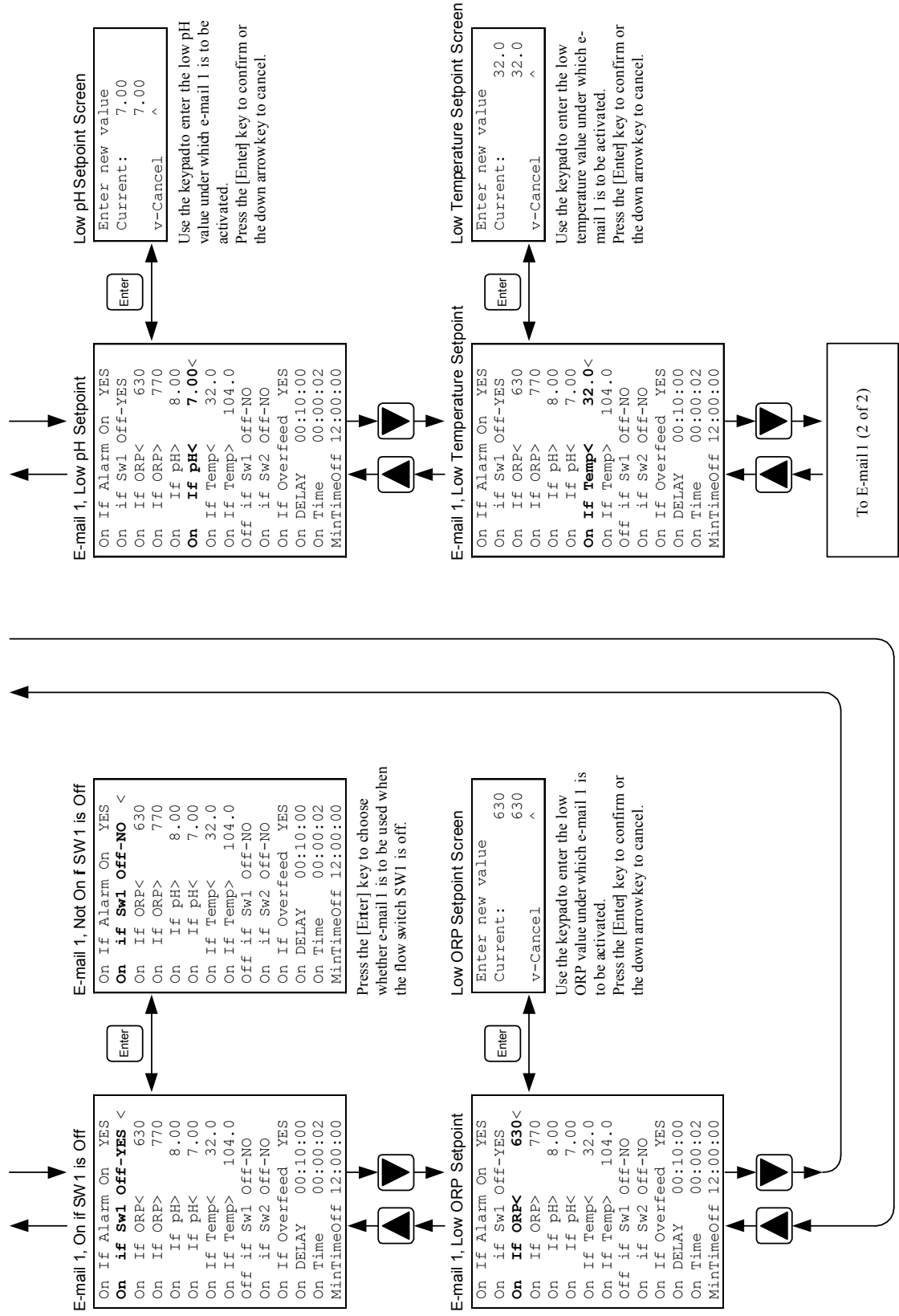

# AK110 Programming Screen Navigation, E-mail 1 (2 of 2)

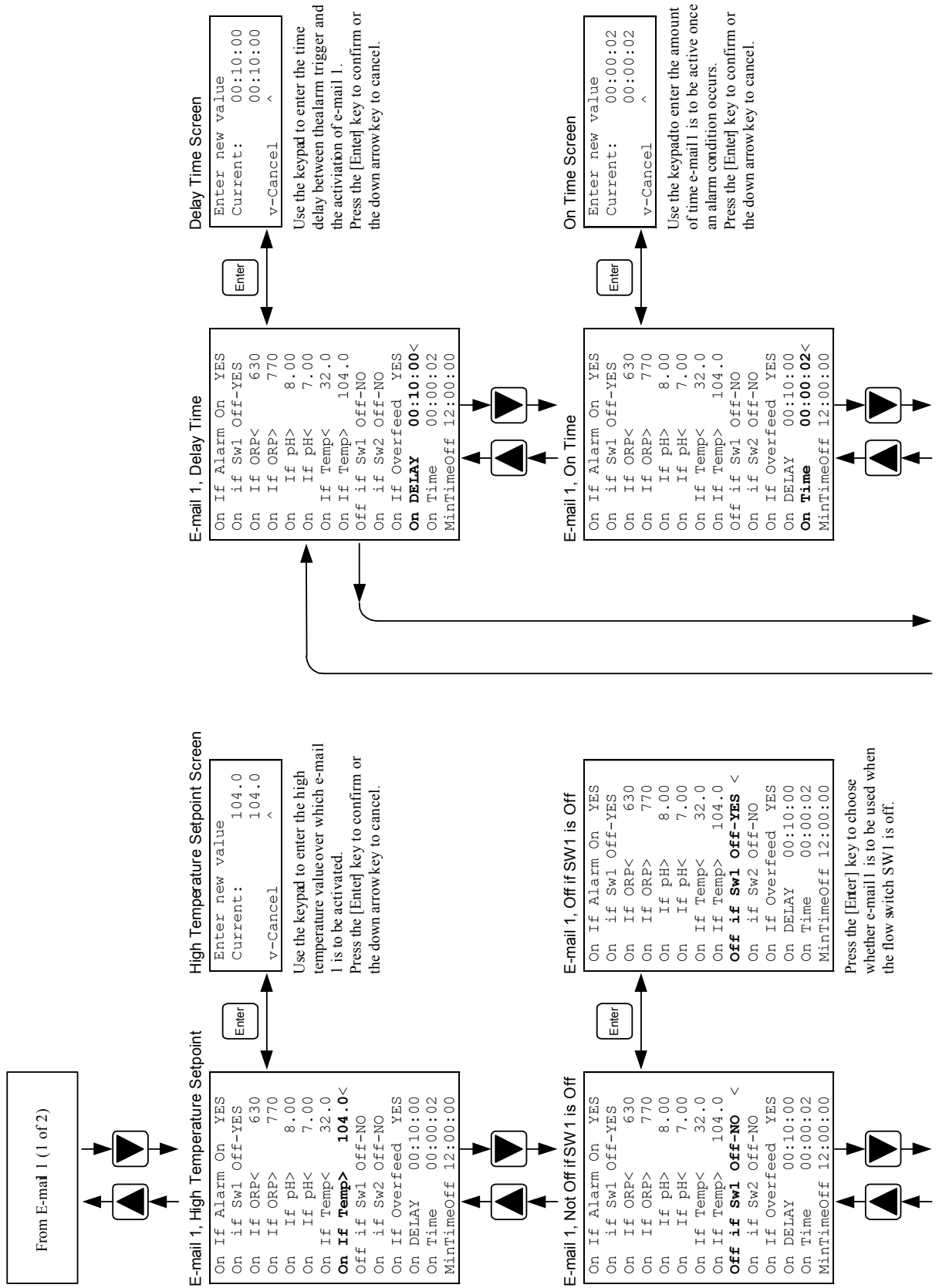

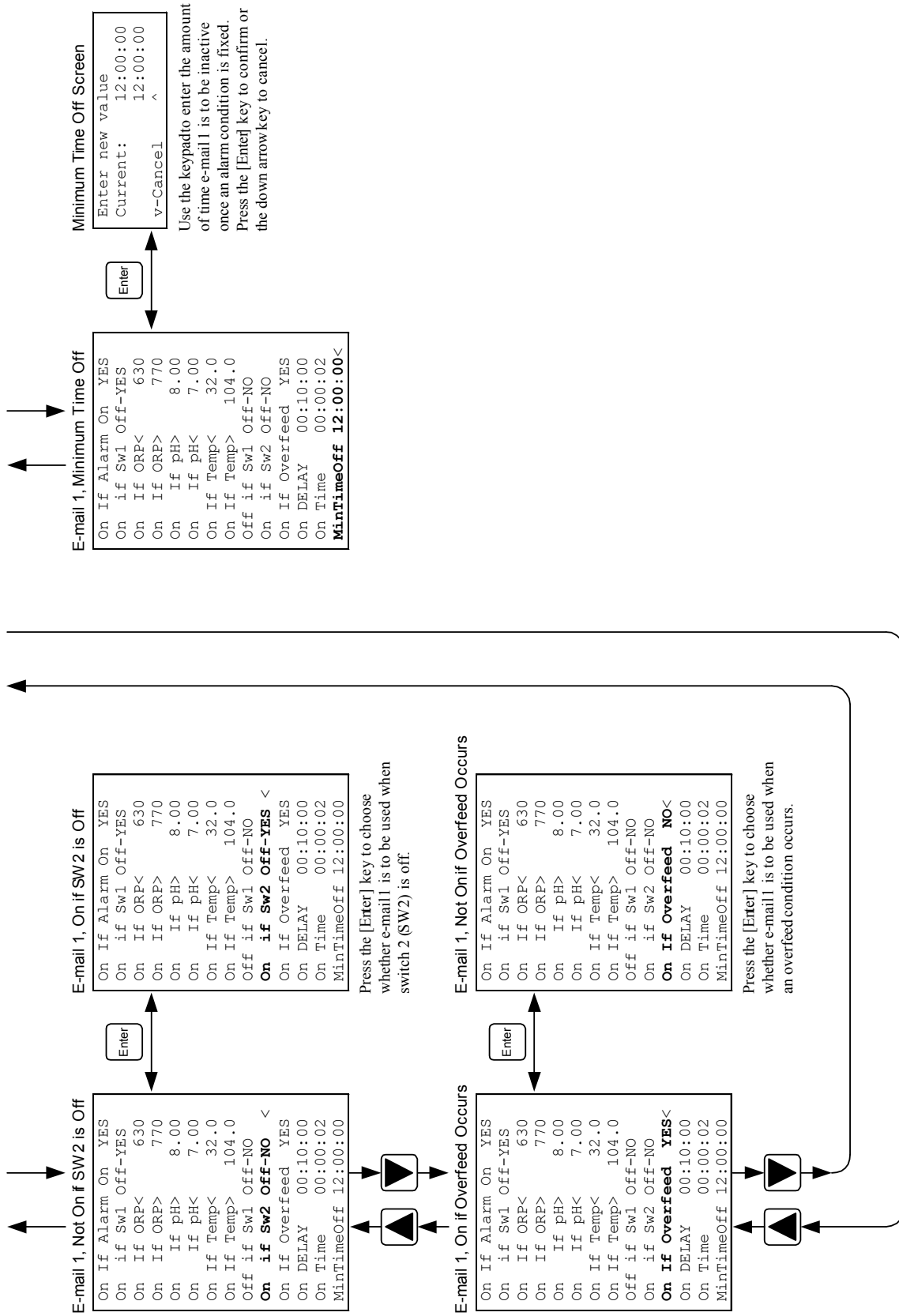

# AK110 Wizards Setup Screen Navigation (1 of 2)

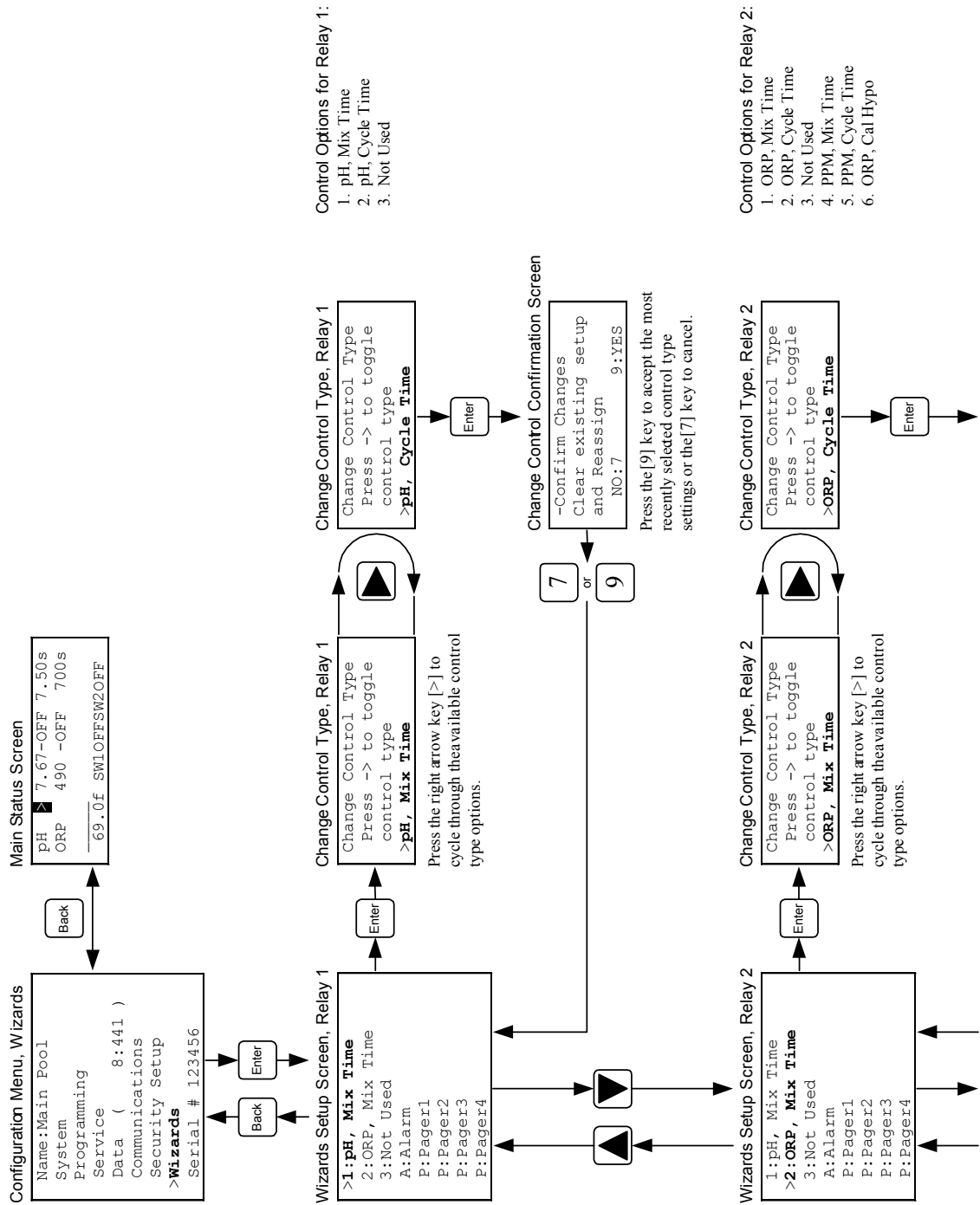

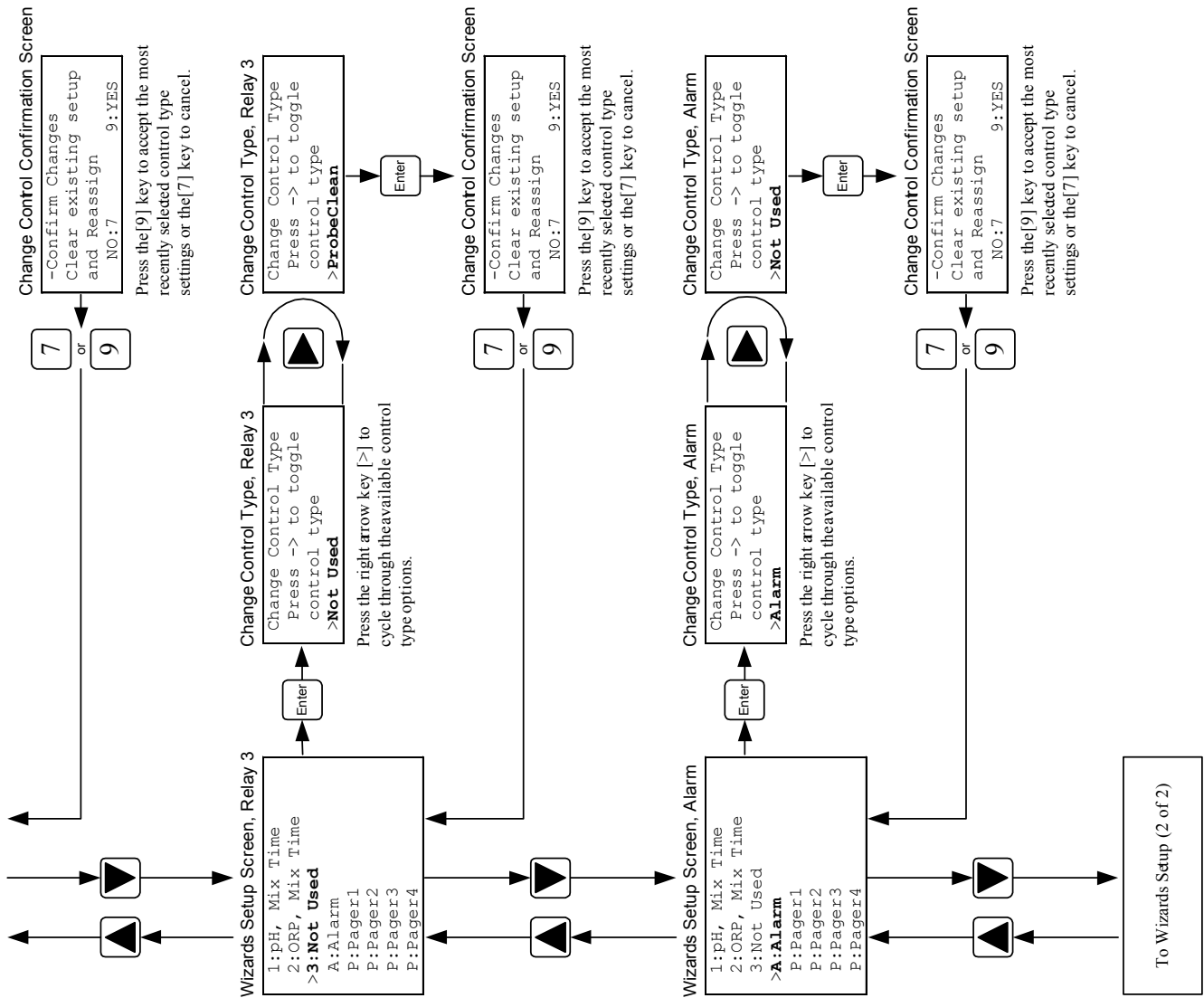

# AK110 Wizards Setup Screen Navigation (2 of 2)

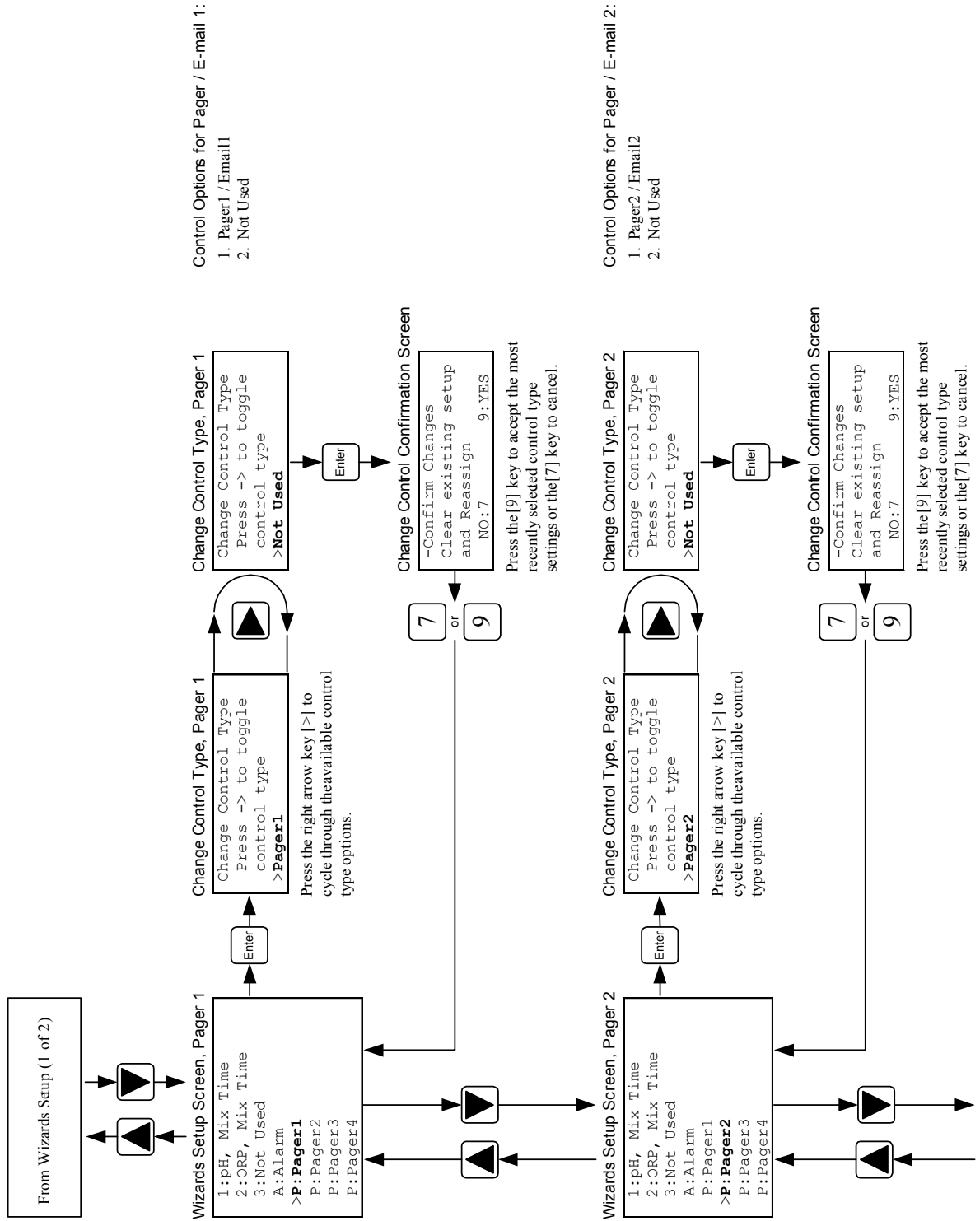

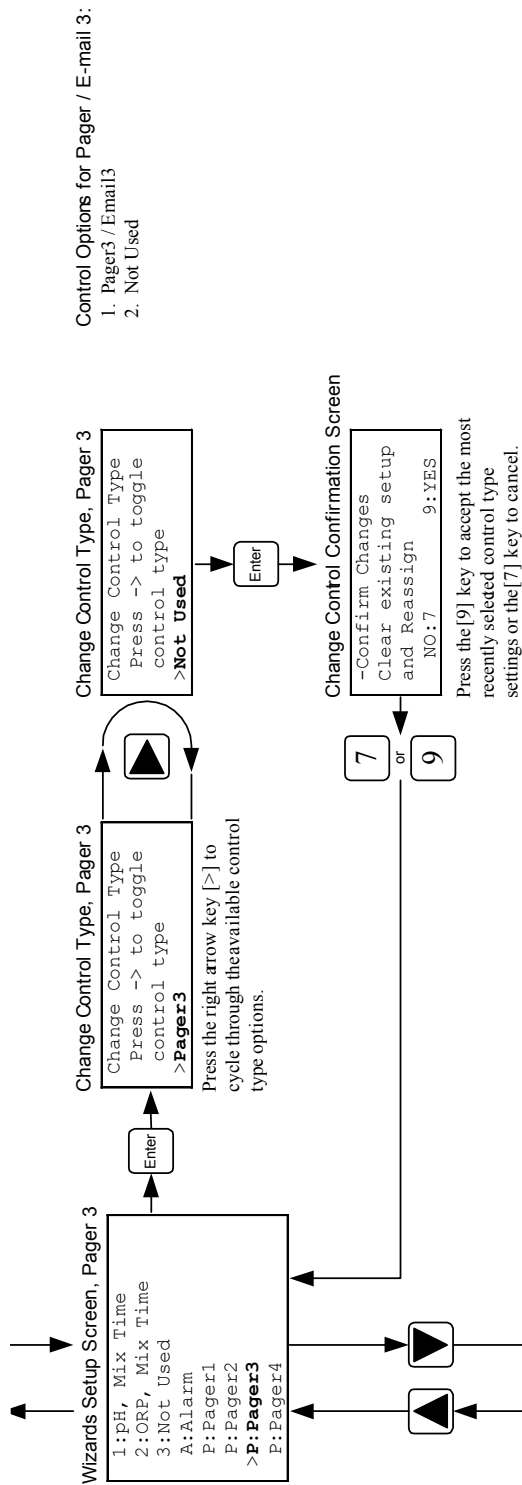

Control Options for Pager / E-mail 3:

1. Pager3 / Email3
2. Not Used

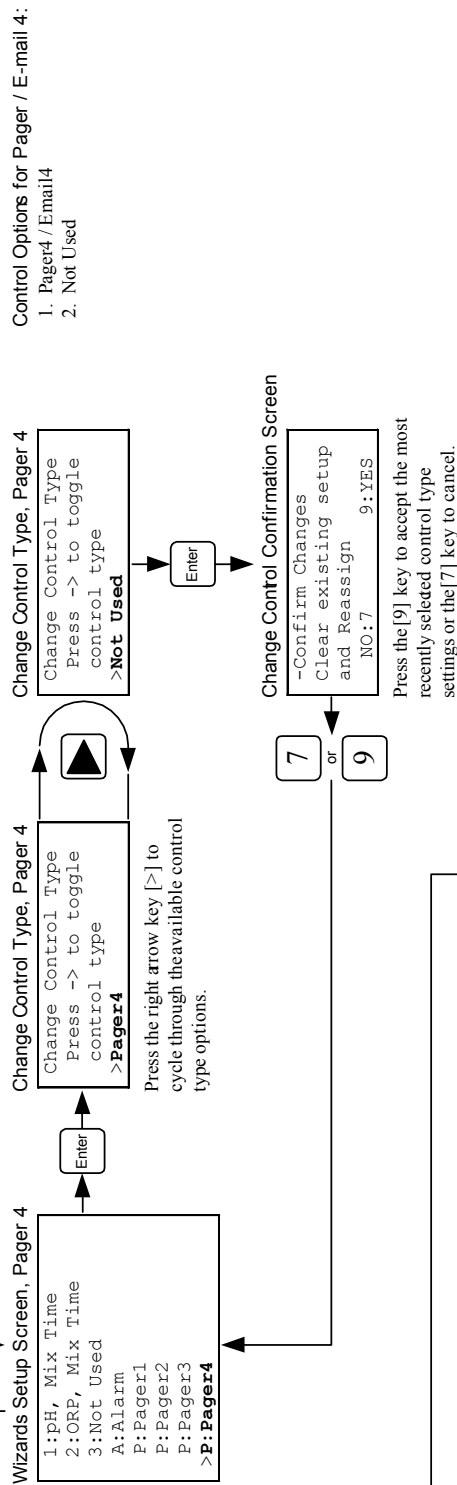

Control Options for Pager / E-mail 4:

1. Pager4 / Email4
2. Not Used

### Wizards Setup Screen and the Modem

The *Wizards Setup Screen* displays four pagers when a dial-up modem (or no modem at all) is installed in the controller.

If a cellular modem is installed in the controller, these four pagers are replaced with similar *E-mail* wizard setup menus.

```

Wizards Setup Screen, E-mail 1
1:pH, Mix Time
2:ORP, Mix Time
3:Not Used
A:Alarm
>P:Email1
P:Email2
P:Email3
P:Email4
  
```

# AK110 Data Screen Navigation

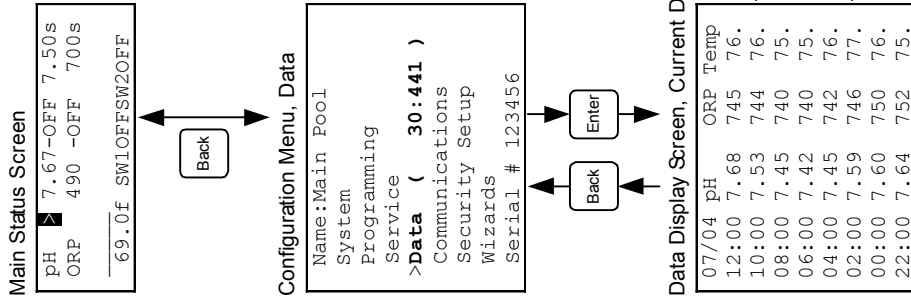

Press the up and down arrow keys to scroll through the recorded data points. Press the [Back] key to return to the configuration menu.

Each row comprises asingle data set. The data collected is dependent upon the type of sensor card installed.

If the standard pH/ORP/Temp sensor card is installed, those specific measurement types will be recorded in the data log



## Sensor Data as Collected, Recorded and Displayed

Data DisplayScreen, Timestamp

07/04	pH	ORP	Temp
12:00	7.68	745	76.
10:00	7.53	744	76.
08:00	7.45	740	75.
06:00	7.42	740	75.
04:00	7.45	742	76.
02:00	7.59	746	77.
00:00	7.60	750	76.
22:00	7.64	752	75.

The first column lists the date and time at which each data set was recorded.

Data Display Screen, pH

07/04	pH	ORP	Temp
12:00	7.68	745	76.
10:00	7.53	744	76.
08:00	7.45	740	75.
06:00	7.42	740	75.
04:00	7.45	742	76.
02:00	7.59	746	77.
00:00	7.60	750	76.
22:00	7.64	752	75.

The second column lists the pH values as measured by the AK110 and pH probe.

Data Display Screen, ORP

07/04	pH	ORP	Temp
12:00	7.68	745	76.
10:00	7.53	744	76.
08:00	7.45	740	75.
06:00	7.42	740	75.
04:00	7.45	742	76.
02:00	7.59	746	77.
00:00	7.60	750	76.
22:00	7.64	752	75.

The third column lists the ORP values (in millivolts) as measured by the AK110 and ORP probe.

Data Display Screen, Temperature

07/04	pH	ORP	Temp
12:00	7.68	745	76.
10:00	7.53	744	76.
08:00	7.45	740	75.
06:00	7.42	740	75.
04:00	7.45	742	76.
02:00	7.59	746	77.
00:00	7.60	750	76.
22:00	7.64	752	75.

The fourth column lists the temperature values (in degrees F or C) as measured by the AK110 and temperature probe.

## Sensor Data Recording Intervals

The AK110 data log is capable of storing up to a maximum of 441 data sets in memory at one time. When this number is exceeded, the oldest data sets are overwritten with the most recently recorded data.

In its default configuration, the AK110 will record data set on each of the "even" hours of a 24-hour clock. This two-hour time interval allows for up to 36 days and 18 hours of data recordings to be stored in the controller's onboard memory.

Via the *System Setup Screen*, the controller can be configured to record data sets on an hourly basis. When so configured, the one-hour time interval allows for up to 18 days and 9 hours of data recordings to be stored in the controller's onboard memory.

Data Display Screen, 2 Hour Intervals

07/04	pH	ORP	Temp
12:00	7.68	745	76.
10:00	7.53	744	76.
08:00	7.45	740	75.
06:00	7.42	740	75.
04:00	7.45	742	76.
02:00	7.59	746	77.
00:00	7.60	750	76.
22:00	7.64	752	75.

The last 8 records shown cover a 16 hour time interval.

Data Display Screen, Hourly Intervals

07/04	pH	ORP	Temp
12:00	7.68	745	76.
11:00	7.59	744	76.
10:00	7.53	744	76.
09:00	7.50	743	75.
08:00	7.45	740	75.
07:00	7.44	739	75.
06:00	7.42	740	75.
05:00	7.43	741	76.

The last 8 records shown cover an 8-hour time interval.

# AK110 Communications Screen for Dial-Up Modems (1 of 2)

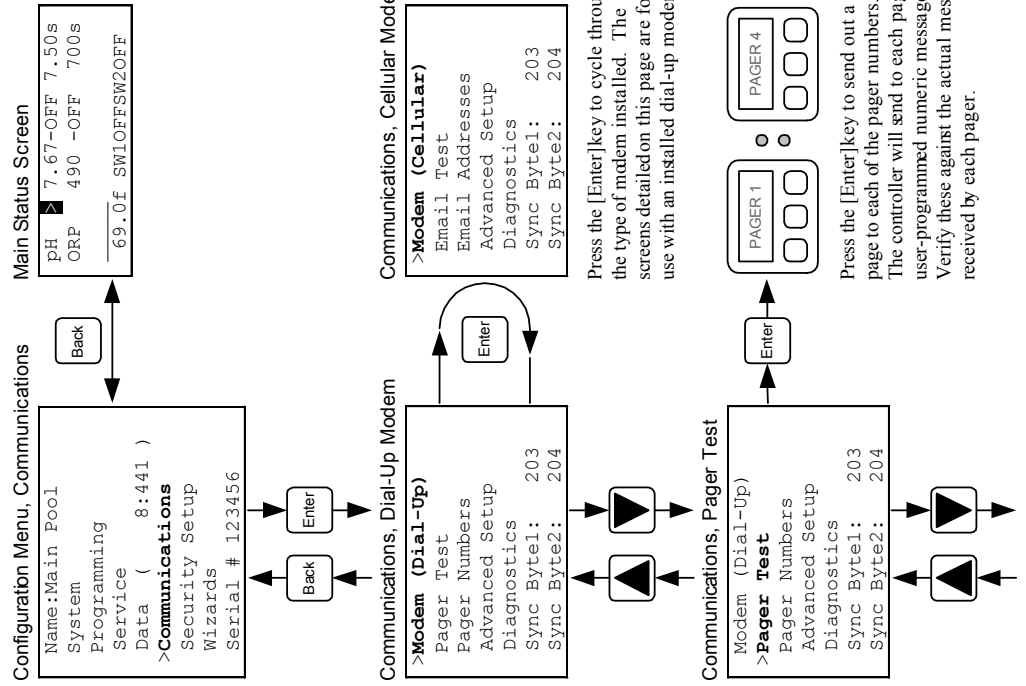

Communications, Pager Numbers

```

Modem (Dial-Up)
Pager Test
>Pager Numbers
Advanced Setup
Diagnostics
Sync Byte1: 203
Sync Byte2: 204
  
```

Communications, Pager Numbers

Pager Numbers, Pager 2

```

>1:1212552368,,1234
56,,11#
2:1212552368,,1234
56,,12#
3:1212552368,,B,,9
9#
4:
  
```

Pager Numbers, Pager 3

```

1:1212552368,,1234
56,,11#
>2:1212552368,,1234
56,,12#
3:1212552368,,B,,9
9#
4:
  
```

Use the up and down arrow keys to cycle through each pager string entry. The AKI10 supports a maximum of four pager string entries.

Enter

Pager Sting Setup Screen

```

1
1212552368,,123456,
,11#
v-Cancel Back-Ins
  
```

Use the keypad to enter the pager string for the pager to be contacted. Press the [Enter] key to confirm or the down arrow key to cancel.

Communications, Advanced Setup

```

Modem (Dial-Up)
Pager Test
Pager Numbers
>Advanced Setup
Diagnostics
Sync Byte1: 203
Sync Byte2: 204
  
```

Advanced Setup, Rings to Answer

```

>Ring to answer: 1
Long hgup: 00:30:00
Reset to Defaults
  
```

Rings to Answer Screen

```

Enter new value
Current: 1
v-Cancel
  
```

Use the keypad to enter the number of rings prior to modem pick-up. Press the [Enter] key to confirm or the down arrow key to cancel.

Advanced Setup, Long Hangup

```

Ring to answer: 1
>Long hgup: 00:30:00
Reset to Defaults
  
```

Long Hangup Screen

```

Enter new value
Current: 00:30:00
v-Cancel
  
```

Use the keypad to enter the minimum time prior to reconnection after a "long hangup". Press the [Enter] key to confirm or the downarrow key to cancel.

Advanced Setup, Reset to Defaults

```

Ring to answer: 1
Long hgup: 00:30:00
>Reset to Defaults
  
```

Reset to Defaults Confirmation Screen

```

-Confirm Changes
-Reset to Defaults
NO:7 9:YES
  
```

Press the [9] key to reset the "Ring to answer" and "Long Hgup" settings or the [7] key to cancel.

# AK110 Communications Screen for Dial-Up Modems (2 of 2)

From Communications Screen for Dial-Up Modems (1 of 2)

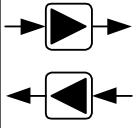

**Communications, Diagnostics**  
 Modem (Dial-Up)  
 Pager Test  
 Pager Numbers  
 Advanced Setup  
 >**Diagnostics**  
 Sync Byte1: 203  
 Sync Byte2: 204



**Modem Diagnostics Screen**  
 +++ATH OK AT&F&C1&D1  
 &XOS8=4 OK  
 Pager OPgD: 0  
 St.s 0 6789 0

The *Modem Diagnostics Screen* displays modem configuration data such as the modem initialization string. This data is intended for use by qualified service personnel.

6

Shortcut to the *Advanced Setup Screen*

>Ring to answer: 1  
 Long hgup: 00:30:00  
 Reset to Defaults

The *Advanced Setup Screen* may quickly be accessed from the *Modem Diagnostics Screen* by pressing the [6] shortcut key.

**Communications, Sync Byte 1**  
 Modem (Dial-Up)  
 Pager Test  
 Pager Numbers  
 Advanced Setup  
 Diagnostics  
 >**Sync Byte1: 203**  
 Sync Byte2: 204



**Sync Byte 1 Screen**

Enter new value 203  
 Current: 203  
 v-Cancel ^

Use the keypad to enter a number from 0 to 255. This is the first sync byte for controller communications security. Press the [Enter] key to confirm or the down arrow key to cancel.

**Communications, Sync Byte 2**  
 Modem (Dial-Up)  
 Pager Test  
 Pager Numbers  
 Advanced Setup  
 Diagnostics  
 Sync Byte1: 203  
 >**Sync Byte2: 204**



**Sync Byte 2 Entry Screen**

Enter new value 204  
 Current: 204  
 v-Cancel ^

Use the keypad to enter a number from 0 to 255. This is the second sync byte for controller communications security. Press the [Enter] key to confirm or the down arrow key to cancel.

### Moving the Cursor in the Pager Number Screen

**Pager Number, Cursor to Left**

1  
 12125552368,,123456,  
 ,12#  
 U  
 v-Cancel Back-Ins

**Pager Number, Cursor to Right**

1  
 12125552368,,123456,  
 ,12#  
 U  
 v-Cancel Back-Ins

The cursor position is indicated by the character "I" (column 1) located directly above the first character of the pager number string. Press the right arrow key to move the cursor one space to the right.

The cursor has moved one space to the right and is now positioned directly above the second character of the pager number string. Press the left arrowkey to return the cursor to its previous position.

## Constructing a Pager String

The information that a pager message can convey is rather more limited than a modem cellular text message. Pager messages may only include numeric characters, and it is therefore necessary to be creative in constructing a meaningful message regarding the controller status.

The pool service professional receiving a notification via pager would likely wish to know which controller sent the message, and under what condition the message was sent. For instance, assume pager 2 has been programmed to send out a message when the ORP drops below a specified level. The body of the message might identify the controller by serial number along with a numeric code that correlates to a low ORP condition (the number "12" has been arbitrarily chosen for this purpose.)

The maximum length of a pager string is 29 characters. This includes the pager number, the embodied message, and any additional control characters. The first portion of the pager string represents the number of the pager to be contacted. Following the pager number is the message body.

A comma (,) in the pager string signifies a four-second pause. All pager strings must be terminated with a pound sign (#). If the character "B" is entered in the message body, the controller will substitute this letter with the last five digits of the unit serial number when sending the message.

In the below example, the controller dials the specified number (1-212-555-2368) and waits eight seconds (two commas) before sending the first portion of the message. In this case, the serial number of the unit (123456) has been manually entered as the first portion of the message. Following another eight-second pause (two more commas) the next portion of the message is sent (12).

The pool service professional receiving the page would then be able to reference the serial number and error condition to identify the specific controller, its location, and the condition that triggered the message.

Pager String Setup Screen

```

2
12125552368,,123456,
,12#           U
v-Cancel    Back-Ins
    
```

## Using the AK110 Keypad to Enter a Pager Number

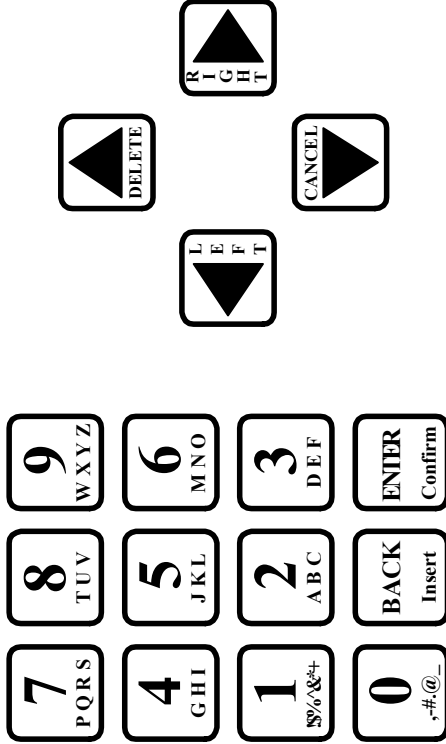

Each numeric key is associated with three or more letters of the alphabet, or with punctuation and other special characters.

Successive keypresses cycle through the various characters associated with each key. For instance, press the [5] key once to display the number "5" on-screen. Press it a second time (while the cursor is in the same position) to display the letter "J". The third keypress displays the letter "K" and the fourth keypress displays the letter "L". Press the key one more time to return to the number "5".

Each of the arrow keys as well as the [Back] and [Enter] keys perform specific functions within the *Pager String Setup Screen*.

Press the up arrow key to delete the character at the cursor position.

Press the left arrow key to move the cursor one space to the left.

Press the right arrow key to move the cursor one space to the right.

Press the down arrow key to cancel out of the pager string entry process.

Press the [Back] key to insert a blank space at the cursor position.

Press the [Enter] key to confirm the pager string as displayed on-screen.

# AK110 Communications Screen for Cellular Modems (1 of 3)

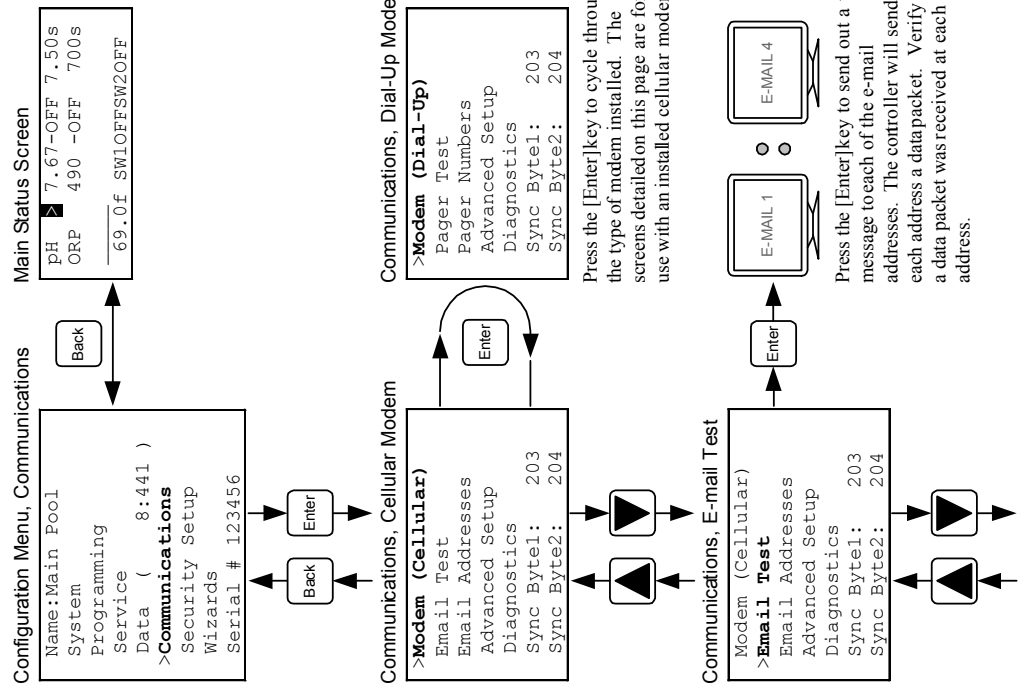

Communications, E-mail Addresses

```

Modem (Cellular)
Email Test
>Email Addresses
Advanced Setup
Diagnostics
Sync Byte1: 203
Sync Byte2: 204
  
```

Enter

E-mail Addresses, E-mail 2

```

>1:albert.einstein@ac
cu-trol.com
2:groucho.marx@acu-
trol.com
3:heddy.lamarr@acu-
trol.com
4:
  
```

E-mail Addresses, E-mail 3

```

1:albert.einstein@a
cu-trol.com
>2:groucho.marx@acu-
trol.com
3:heddy.lamarr@acu-
trol.com
4:
  
```

Use the up and down arrow keys to cycle through each e-mail address entry. The AK110 supports a maximum of four address entries.

Enter

E-mail Address Setup Screen

```

1
albert.einstein@acu-
trol.com
v-Cancel Back-Ins
  
```

Use the keypad to enter the e-mail address into the address book. Press the [Enter] key to confirm or the down arrow key to cancel.

Communications, Advanced Setup

```

Modem (Cellular)
Email Test
Email Addresses
>Advanced Setup
Diagnostics
Sync Byte1: 203
Sync Byte2: 204
  
```

Enter

Advanced Setup Screen

```

IP=166.213.212.193
M# =
ATTN - 87 dBm
> GOOD Signal
CurBytes987
HourBytes 456
Clear All Bytes
Check IP
Signal Loop
Restart
EmailData# 1
@ hour # 8
cc Email# 3
Data Interval: 0
Packet # 5
Send Data Packet
  
```

Enter

To Communications Screen for Cellular Modems (3 of 3)

To Communications Screen for Cellular Modems (2 of 3)

The *Advanced Setup Screen* conveys the following information with respect to the cellular connection:

- "IP=166.213.212.193"  
This is the IP address assigned to the cellular modem.
- "ATTN - 87 dBm"  
This is a measurement of the cellular signal strength, in minus dBm.
- "GOOD Signal"  
This is a relative indicator of the overall cellular signal quality.
- "CurBytes"  
Total number of bytes sent and received over the cellular connection.
- "HourBytes"  
Number of bytes sent and received over the cellular connection within the last hour.
- "Packet#"  
Total number of data packets sent out to Acu-Manage.

# AK110 Communications Screen for Cellular Modems (2 of 3)

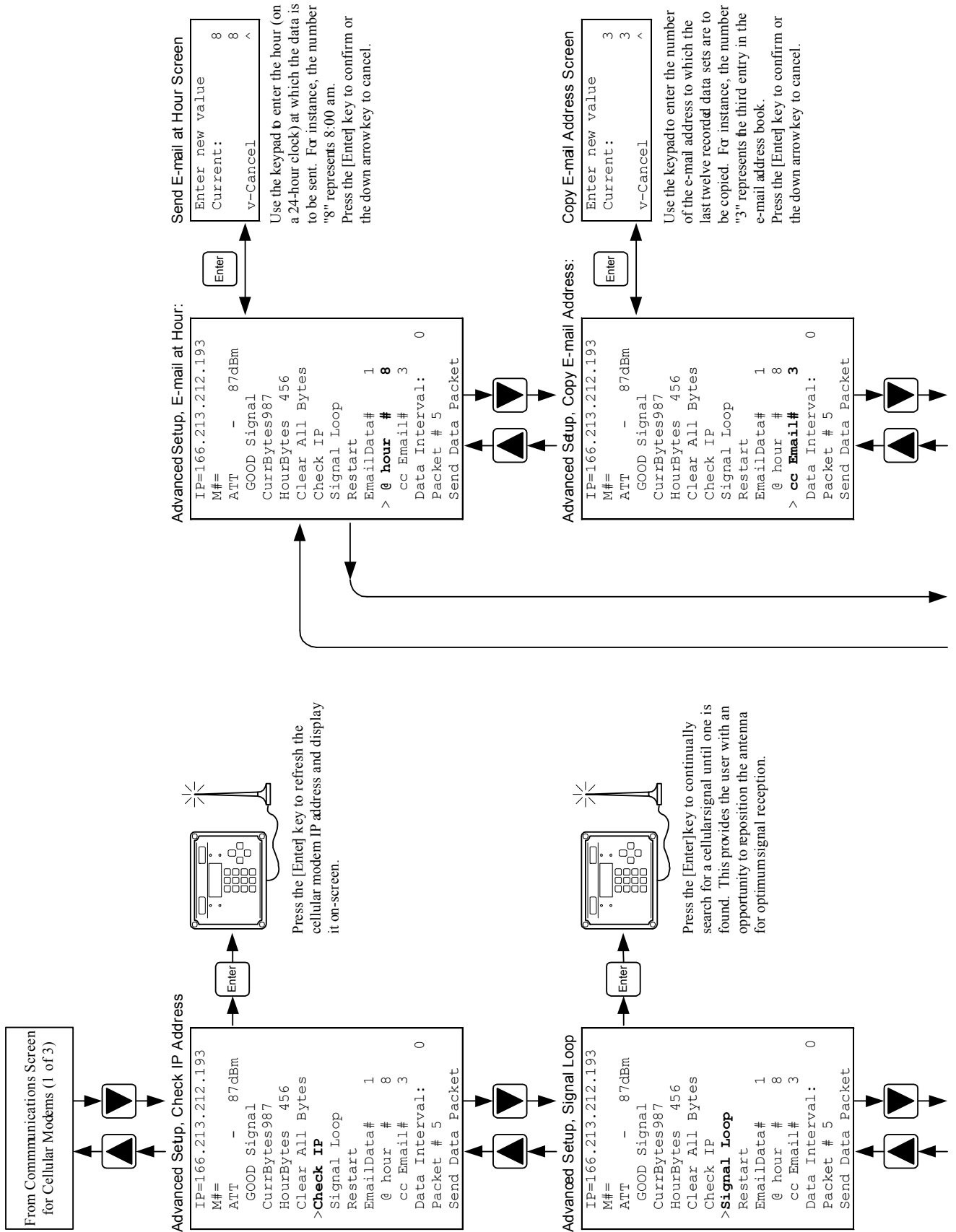



**Advanced Setup, Restart Modem**

```

IP=166.213.212.193
M#=
ATT - 87dBm
GOOD Signal
CurrBytes987
HourBytes 456
Clear All Bytes
Check IP
Signal Loop
>Restart
EmailData# 1
@ hour # 8
cc Email# 3
Data Interval: 0
Packet # 5
Send Data Packet
  
```

Press the [Enter] key to restart the modem. The modem will disconnect from the network, reboot, search for a signal, and then reconnect to the cellular network.

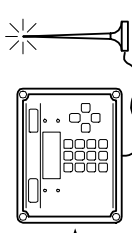

Enter

**Advanced Setup, Send E-mail to:**

```

IP=166.213.212.193
M#=
ATT - 87dBm
GOOD Signal
CurrBytes987
HourBytes 456
Clear All Bytes
Check IP
Signal Loop
Restart
>EmailData# 1
@ hour # 8
cc Email# 3
Data Interval: 0
Packet # 5
Send Data Packet
  
```

**Send E-mail to Address Screen**

```

Enter new value 1
Current: 1
v-Cancel
  
```

Use the keypad to enter the number of the e-mail address to which the last twelve recorded data sets are to be sent. For instance, the number "1" represents the first entry in the e-mail address book. Press the [Enter] key to confirm or the down arrow key to cancel.

Enter

**Advanced Setup, Data Interval**

```

IP=166.213.212.193
M#=
ATT - 87dBm
GOOD Signal
CurrBytes987
HourBytes 456
Clear All Bytes
Check IP
Signal Loop
Restart
EmailData# 1
@ hour # 8
cc Email# 3
>Data Interval: 0
Packet # 5
Send Data Packet
  
```

Enter

**Advanced Setup, Send Data Packet**

```

IP=166.213.212.193
M#=
ATT - 87dBm
GOOD Signal
CurrBytes987
HourBytes 456
Clear All Bytes
Check IP
Signal Loop
Restart
EmailData# 1
@ hour # 8
cc Email# 3
Data Interval: 0
Packet # 5
>Send Data Packet
  
```

Enter

**Advanced Setup, Data Interval**

```

IP=166.213.212.193
M#=
ATT - 87dBm
GOOD Signal
CurrBytes987
HourBytes 456
Clear All Bytes
Check IP
Signal Loop
Restart
EmailData# 1
@ hour # 8
cc Email# 3
>Data Interval: 15
Packet # 5
Send Data Packet
  
```

Press the [Enter] key to set the time interval after which data packets will be to the Acu-Manage web site. The interval can be set from 0 minutes (no data) to 240 minutes.

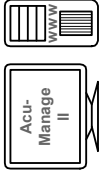

Press the [Enter] key to prompt the modem to immediately send a data packet to the Acu-Manage II web site.

# AK110 Communications Screen for Cellular Modems (3 of 3)

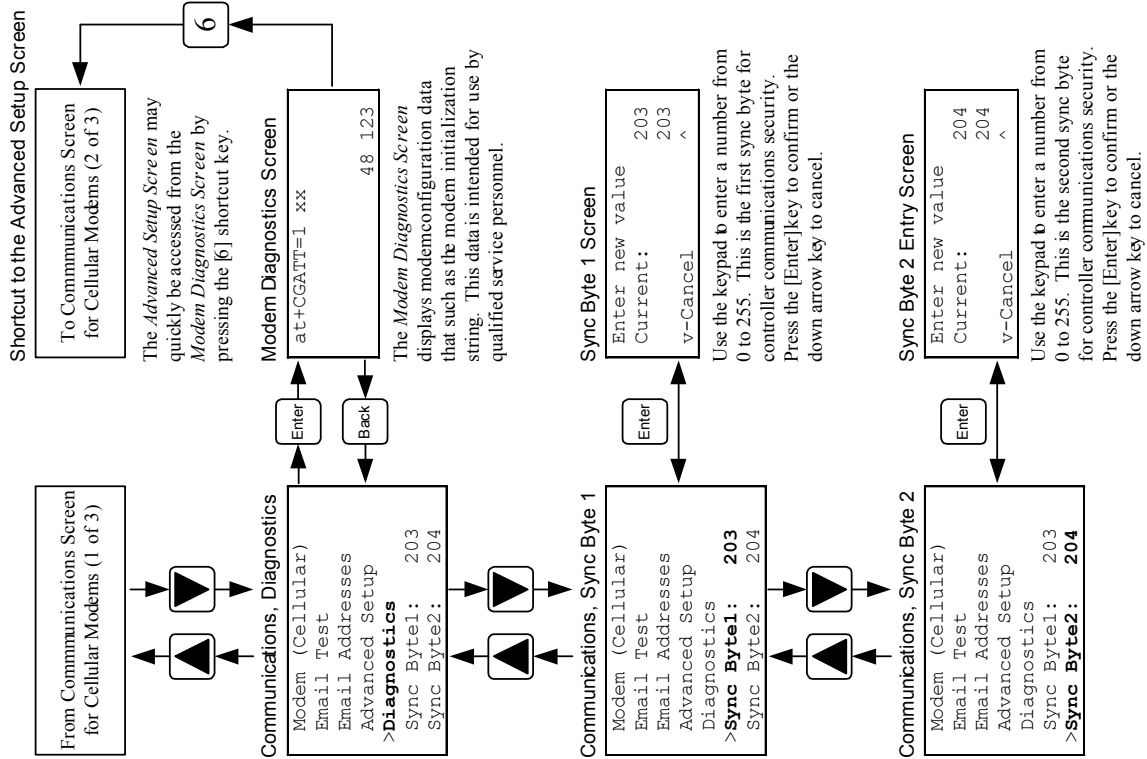

## Parsing E-mail Address Entries

A single e-mail address entry may be up to 29 characters in length. For longer e-mail addresses, it's possible to "split" an e-mail address between two separate address book entries. The means of accomplishing this is shown in *Example 1* on the right. This feature also proves useful when multiple e-mail addresses share the same domain name.

**Example 1: Long E-mail Address**

```
1: John.jingleheimer
   schmidt@+02
>2: acu-trol.com
3:
4:
```

Due to John's extraordinarily long surname, his entire e-mail address will not fit in a single address book entry. To work around this, the e-mail address is split into separate "user name" and "domain name" entries, with a numeric pointer to connect the two.

**Example 2: Shared Domain Name**

```
1: moe.howard@+04
2: Larry.fine@+04
3: curly.howard@+04
>4: acu-trol.com
```

Moe, Larry, and Curly all share the same e-mail domain name. It is therefore convenient to give the domain name an e-mail address entry of its own.

In the second example on the right, three highly professional pool service personnel have e-mail addresses which share the same "acu-trol.com" e-mail domain name. The domain name (which comprises the last portion of the e-mail address) is slotted into the fourth address book entry. Each of the three individual e-mail recipients are given a partial entry comprising of the first portion of their respective e-mail addresses (do not forget to include the '@' symbol). Each entry includes a numeric pointer (+04) added the end of the address entry location where the domain name resides.

When an e-mail is sent out to address 1, the controller will append the user name (moe.howard@) to the domain name (acu-trol.com) specified by the pointer (+04) which follows the user name. Thus, the reconstructed e-mail address becomes "mohoward@acu-trol.com". The same will be true for address entries 2 and 3.

## Moving the Cursor

**E-mail Address, Cursor to Left**

**E-mail Address, Cursor to Right**

The cursor position is indicated by the character "I" located directly above the first character in the e-mail address.

Press the right arrow key to move the cursor one space to the right.

The cursor has moved one space to the right and is now positioned directly above the second character in the e-mail address.

Press the left arrowkey to return the cursor to its previous position.

## Using the AK110 Keypad to Enter an E-mail Address

## Changing between Upper and Lower Case Letters

To change between upper case and lower case letters, press the left arrow key until the cursor is in the leftmost position, then press the left arrow key once again. The letter "U" in the lower right corner of the display indicates whether subsequent text entered will be lower case or upper case.

**E-mail Address, Upper Case Text**

**E-mail Address, Lower Case Text**

An upper case "U" in the lower right corner of the display indicates that letters entered in via the keypad will be displayed in upper case.

A lower case "u" in the lower right corner of the display indicates that letters entered in via the keypad will be displayed in lower case.

Each numeric key is associated with three or more letters of the alphabet, or with punctuation and other special characters.

Successive keypresses cycle through the various characters associated with each key. For instance, press the [5] key once to display the number "5" on-screen. Press it a second time (while the cursor is in the same position) to display the letter "J". The third keypress displays the letter "K" and the fourth keypress displays the letter "L". Press the key one more time to return to the number "5".

Each of the arrow keys as well as the [Back] and [Enter] keys perform specific functions within the *E-mail Address Setup Screen*.

Press the up arrow key to delete the character at the cursor position.

Press the left arrow key to move the cursor one space to the left.

Press the right arrow key to move the cursor one space to the right.

Press the down arrow key to cancel out of the e-mail address entry process.

Press the [Back] key to insert a blank space at the cursor position.

Press the [Enter] key to confirm the e-mail address as displayed on-screen.

# AK110 Security Setup Screen Navigation

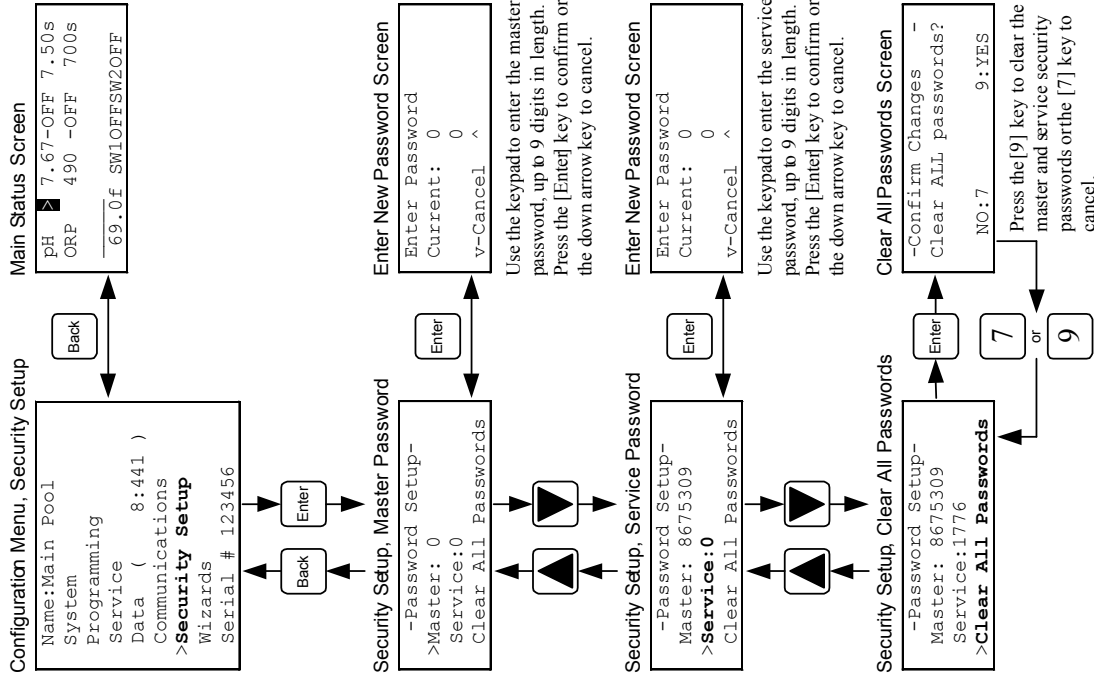

## Using the AK110 Security Password Feature

Up to two levels of security may be implemented on the AK110 controller.

The *Master* password enables access to all controller functions and menus. A master password may be implemented alone, or in conjunction with a service password.

The more limited *Service* password allows access to sensor calibration screens from the *Main Status Screen*. A service password may be implemented only after a master password has been implemented.

The password chosen by the user is simply a number, consisting of a minimum of one digit and a maximum of nine digits. There are, however, a few restrictions when choosing a password:

1. The password may not begin with a zero [0] as the first digit.
2. The security password must be in the range of "1" to "999999999", with the exception of tworeserved number ranges.
3. The numbers in the ranges of 9000 to 9100 and 9276100 to 9276110 are reserved and cannot be used for security password purposes.

Both passwords may be cleared simultaneously, by selecting the *Clear All Passwords* option on the *Security Setup Screen*. This effectively turns off the AK110 security feature. Alternatively, entering a password of "0" will disable the password feature.

In order for the passwords to be cleared, the user must have first entered in a master password to gain access to the *Security Setup Screen*.

### Master Password Example

Main Status Screen

```
pH 7.67-OFF 7.50s
ORP 490 -OFF 700s
69.0f SW1OFFSW2OFF
```

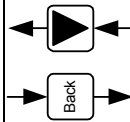

Password Prompt Screen

```
Enter Password
Enter:
v-Cancel
```



Password Displayed as Asterisks

```
Enter Password
Enter: *****
v-Cancel
```



Configuration Menu Screen

```
>Name:Main Pool
System
Programming
Service
Data ( 8:441 )
Communications
Security Setup
Wizards
Serial # 123456
```

### Service Password Example

Main Status, cursor at pH value

```
pH 7.67-OFF 7.50s
ORP 490 -OFF 700s
69.0f SW1OFFSW2OFF
```

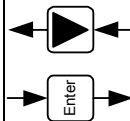

Password Prompt Screen

```
Enter Password
Enter:
v-Cancel
```



Password Displayed as Asterisks

```
Enter Password
Enter: ****
v-Cancel
```



Calibration Screen, pH

```
Enter new value
Current: 7.67
v-Cancel ^
```

# AK110 AKColor™ Screen Navigation

## The AK110 Controller and the AKColor™ Sensor

The AK110 controller may be configured to interface with the *Act-Trol AKColor™ Colorimetric Sensor*. This requires the installation of an optional colorimetric PPM-capable sensor card in place of the standard pH/ORP/Temperature sensor card.

The AK110, when interfaced to an *AKColor™* sensor, may only make measurements for "free" chlorine PPM, even if the *AKColor™* is equipped to make "total" chlorine PPM measurements as well.

When the *AKColor™* with *ORP backup* sensor card is installed in the controller, it is automatically detected upon power-up. The type of sensor card detected will determine which sensor readings or menu options are available to the user. The variations of the user interface with an *AKColor™* with *ORP backup* sensor card are outlined on this page.

A primary difference is the supplanting of the default ORP measurement-based control with PPM measurement-based control of relay 2. With an *AKColor™* with ORP backup sensor card installed, the AK1D will control relay 2 based upon PPM measurements as long as the DPD level is estimated to be above 0%. When the estimated DPD level drops to 0%, relay 2 will instead be controlled based upon ORP measurements.

Configuration options for the *AKColor™* sensor are made available on the *Configuration Menu Screen*.

The status of the *AKColor™* sensor is displayed on the *AKColor™ Status Screen*, which is easily accessible from the *Main Status Screen*.

Configuration Menu, Controller Name

```
>Name: Main Pool
System
Programming
Service ( 8:441 )
Data
Security Setup
Wizards
AKCOLOR
```

Back

Main Status Screen, AKColor™

```
pH 7.67-OFF 7.50s
PPM 2.65-OFF 2.00s
69.0f SW1OFFSW2OFF
```

AKColor™ Status Screen

```
FREE= 2.65 75/320
MixingDPD
lvl= 90%
CLRv= 3.48 v= 1.98
```

The *AKColor™ Status Screen* displays the sensor status, clear and DPD-mixed voltage levels, and the calculated free chlorine PPM.

## Viewing PPM and ORP Measurements and Setpoints

When an *AKColor™* with ORP backup sensor module is installed, the second row of the display will alternate between showing PPM and ORP information. When chemicals are estimated to be present in the *AKColor™*, the PPM measurement and setpoint will both be displayed.

Main Status Screen, PPM Shown

```
pH 7.67-OFF 7.50s
PPM 2.65-OFF 2.00s
69.0f SW1OFFSW2OFF
```

PPM measurement and setpoint shown on the second display row. Relay 2 is controlled by PPM.

Main Status Screen, ORP Shown

```
pH 7.67-OFF 7.50s
ORP 490 -OFF 700s
69.0f SW1OFFSW2OFF
```

ORP measurement and setpoint shown on the second display row. Relay 2 is still controlled by PPM.

When the AK110 estimates that the DPD and buffer solutions have been consumed, the PPM measurement is shown, but the setpoint displays an error condition.

Main Status Screen, AKColor™ Empty

```
pH 7.67-OFF 7.50s
PPM 2.65-OFF err
69.0f SW1OFFSW2OFF
```

PPM measurement and "error condition" shown on the display second row as second row indicates an empty bottle.

Main Status Screen, ORP Shown

```
pH 7.67-OFF 7.50s
ORP 490 -OFF 700s
69.0f SW1OFFSW2OFF
```

ORP measurement and setpoint shown on the display second row as normal. ORP now controls relay 2.

**Configuration Menu, Data**

```
Name:Main Pool
System
Programming
Service
>Data ( 8:441 )
Communications
Security Setup
Wizards
AKCOLOR
Serial # 123456
```

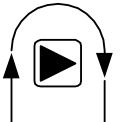

**Data Display Screen**

	pH	PPM	Temp
12:00	7.53	2.88	76.
10:00	7.45	3.02	75.
08:00	7.42	3.14	75.
06:00	7.45	2.06	76.
04:00	7.59	1.95	77.
02:00	7.60	1.81	76.
00:00	7.64	1.72	75.
22:00	7.68	1.99	75.

Colorimetric PPM readings are displayed in the third column of the *Data Display Screen*.

**Configuration Menu, AKColor™**

```
Name:Main Pool
System
Programming
Service
Data ( 8:441 )
Communications
Security Setup
Wizards
>AKCOLOR
Serial # 123456
```

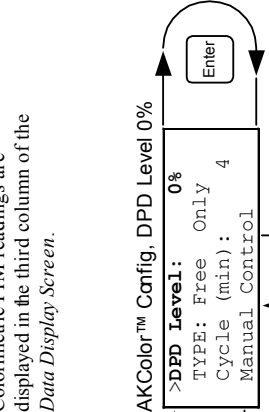

**AKColor™ Config, DPD Level 0%**

```
>DPD Level: 0%
TYPE: Free Only
Cycle (min): 4
Manual Control
```

Press the [Enter] key to set the estimated remaining DPD reagent level from 0% to 100%, in varying increments.

**AKColor™ Config, DPD Level 0%**

```
DPD Level: 0%
>TYPE: Free Only
Cycle (min): 4
Manual Control
```

The AKI 10 controller is limited to taking "free" chlorine PPM measurements with the *AKColor™* sensor.

**AKColor™ Config, 4 Minute Cycle**

```
DPD Level: 0%
TYPE: Free Only
>Cycle (min): 4
Manual Control
```

**AKColor™ Config, 5 Minute Cycle**

```
DPD Level: 0%
TYPE: Free Only
>Cycle (min): 5
Manual Control
```

Press the [Enter] key to set the *AKColor™* measurement cycle time from 3 minutes to 15 minutes, in 1 minute increments.

**AKColor™ Config, Manual Control**

```
DPD Level: 0%
TYPE: Free Only
Cycle (min): 4
>Manual Control
```

**AKColor™ Manual Control Screen**

```
AKCOLOR Ctrl: v=1.98
0=BUFF 1=DPD
2=Flow 3=OFF
4=TOT 8=AllOn
```

The *AKColor™ Manual Control Screen* allows for manual user control of the *AKColor™* solenoids for setup and troubleshooting purposes.

# AK110 Service Screen Navigation

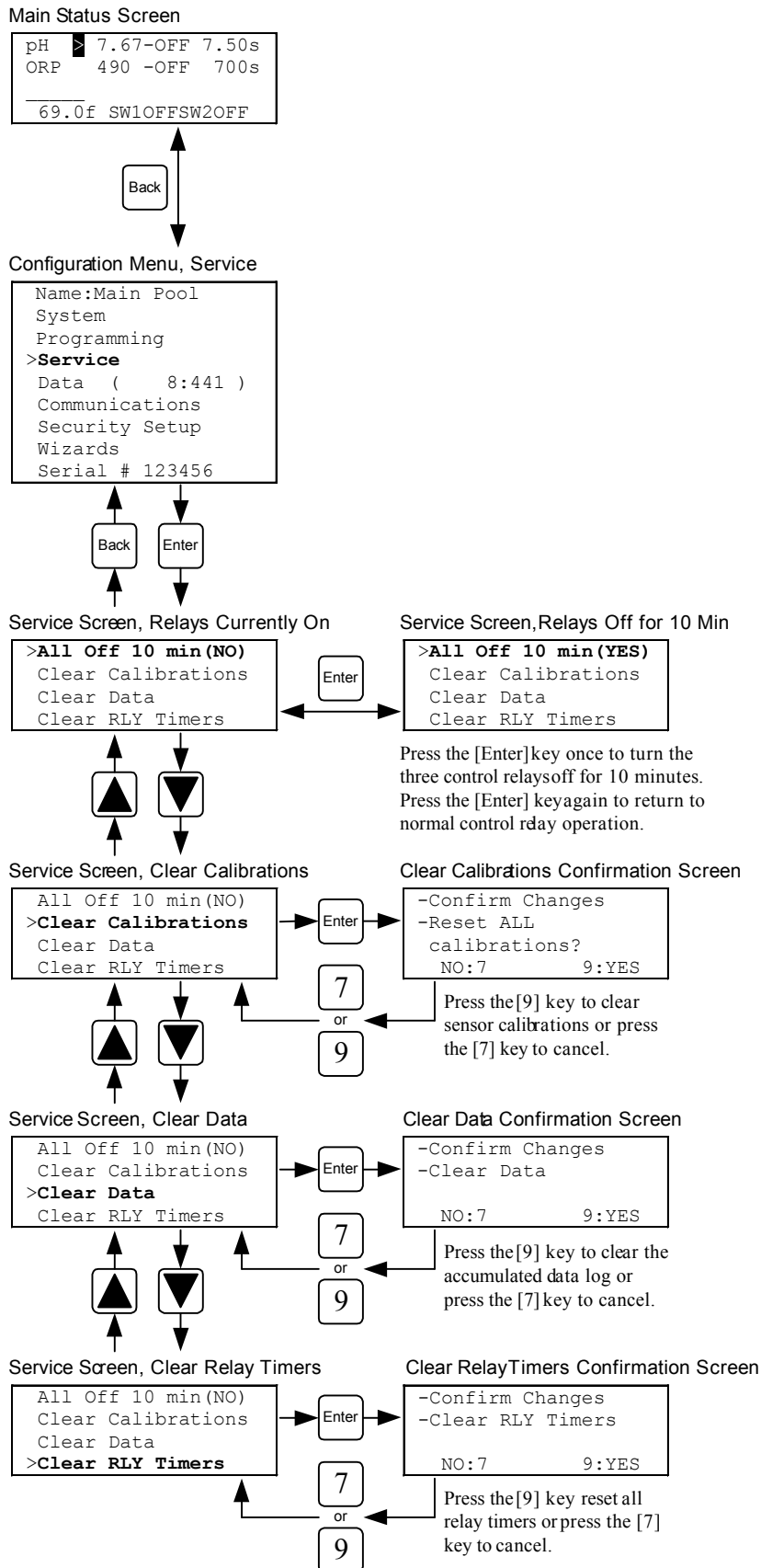



## ORP and PPM Chart

<b>PPM CL</b>	<b>PPM v. ORP at pH 7.4-7.6</b>																					
<b>5</b>																						
<b>4.5</b>																						
<b>4</b>																						
<b>3.5</b>																						
<b>3</b>																						
<b>2.5</b>																						
<b>2</b>																						
<b>1.5</b>																						
<b>1</b>																						
<b>0.5</b>																						
<b>ORP</b>	<b>690</b>	<b>695</b>	<b>700</b>	<b>705</b>	<b>710</b>	<b>715</b>	<b>720</b>	<b>725</b>	<b>730</b>	<b>735</b>	<b>740</b>	<b>745</b>	<b>750</b>	<b>755</b>	<b>760</b>	<b>765</b>	<b>770</b>	<b>775</b>				

How to use this chart:

1. The values on the left side of the chart are free-chlorine PPM. The values on the bottom are the approximate equivalent ORP Values. The gray boxes are pH values.
2. Use a DPD test kit to determine the current pH and PPM conditions of the system you wish to control with the Acu-Trol Controller. The pool water should be balanced to your desired pH and PPM levels before you calibrate the system.
3. Locate the PPM chlorine value on the chart that matches the PPM measurement obtained with your DPD test kit. Follow the horizontal line across until it crosses into the gray pH value box that matches the pH value obtained with your test kit.
4. Follow the approximate pH value down to the bottom of the chart to find the approximate equivalent ORP value. This is the approximate ORP value your Controller should read. A variation of +/- 20 ORP units may occur. This range in ORP is due to different mineral contents of water in different areas. The ORP reading will fluctuate slightly depending on the mineral content of your system.
5. When calibrating your ORP to a tested PPM value, use this chart's approximate ORP value as a starting point. Then adjust the ORP value until the PPM reading in the Controller matches the PPM measurement obtained from your test kit.

# AK110 Pool and Spa Chemical Controller Illustrated Parts

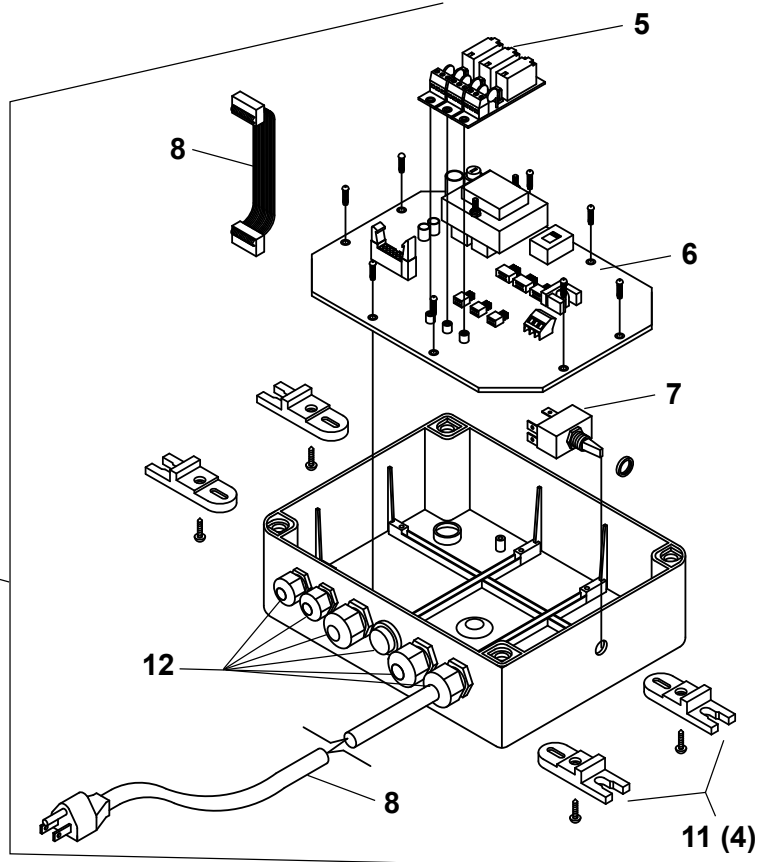
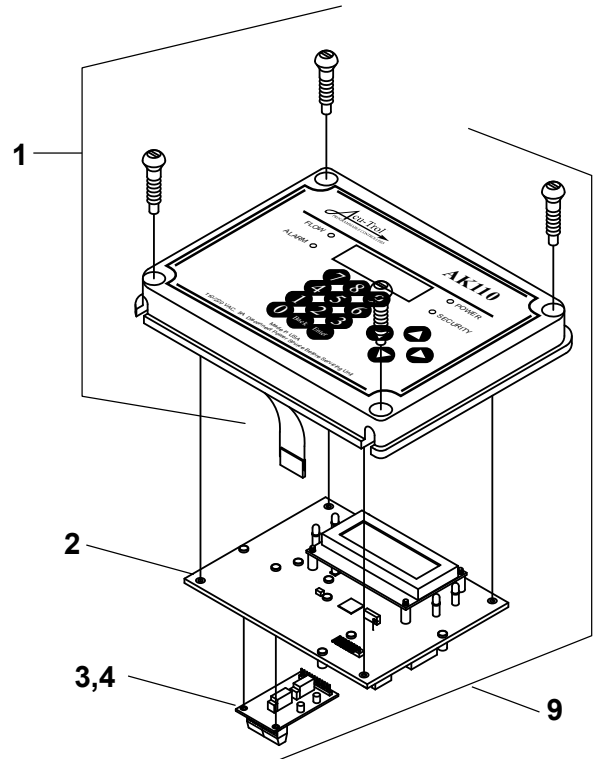
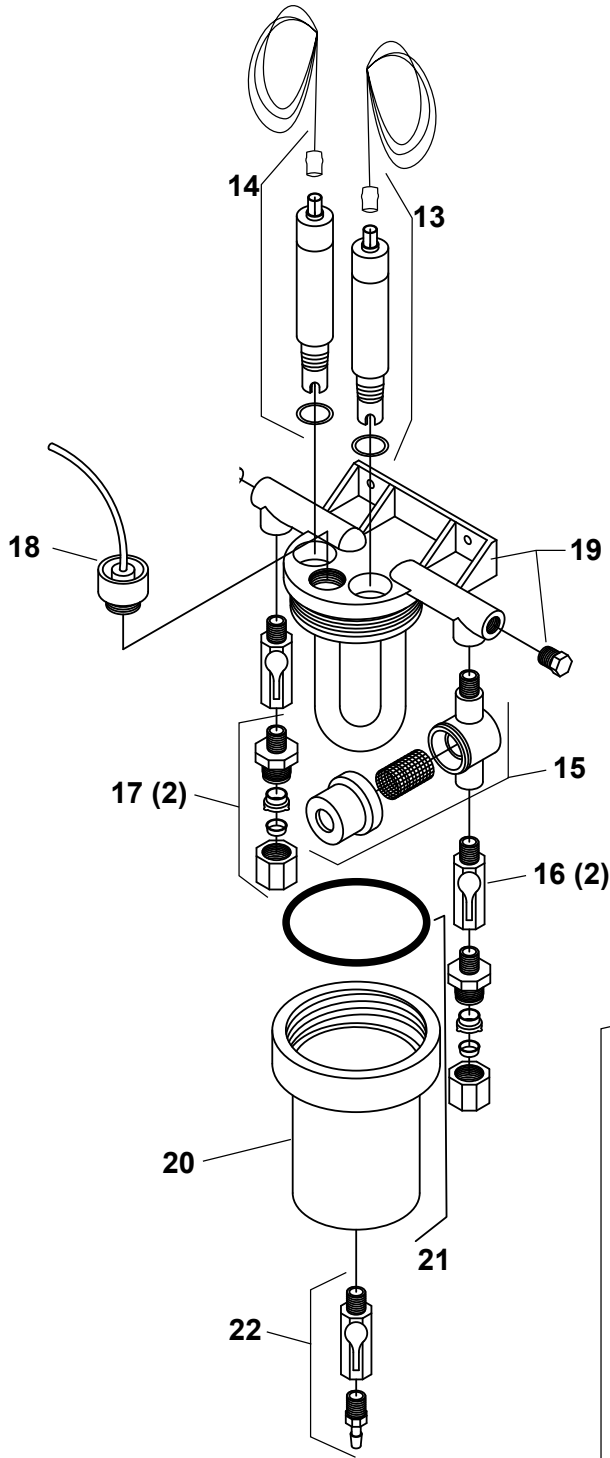

---

## AK110 Pool and Spa Chemical Controller Illustrated Parts List

DWG. #	PART #	DESCRIPTION
1	715000150	Enclosure, Lid, w/overlay and hardware
2	724000260	PCB, Control Board, w/display and hardware
3	724000010	PCB, Sensor, pH/orp/temp w/hardware
4	724000020	PCB, Sensor, pH/temp/AKColor, w/hardware
NS	724000280	PCB, Module, Real Time Clock, w/hardware
NS	724000290	PCB, Module, RS232 adapter, w/hardware (optional)
5	724000050	PCB, Module, Relay, w/hardware
6	724000300	PCB, Relay board, w/hardware (3)
7	714000270	Switch, ON/Off, w/jumpers, wires, power cord, strain relief
8	714000210	Cable, Ribbon
9	714000280	Enclosure, Top Half, Complete
10	714000290	Enclosure, Bottom Half, Complete
NS	714000170	Fuse, 1 AMP
NS	714000180	Fuse, 5 AMP
11	754001910	Mounting Feet (4)
12	714000300	Strain Relief (2 small , 3 large)
13	744000270	Kit, pH Sensor, w/BNC Cable
14	744000340	Kit, ORP Sensor, w/BNC Cable
NS	754000320	Parts Bag, Flow Cell, Complete
15	754000360	Filter, Flow Cell
16	754002010	Ball Valve (2)
17	754002000	Fitting, Jaco (2)
18	754000440	Switch, Flow, w/10' cable
19	754001990	Top, Flow Cell, w/ flow switch and nylon plugs
20	754000340	Clear Jelly Jar, Flow Cell, w/o-ring
21	754000350	O-ring, Clear Jelly Jar, Flow Cell
22	754001980	Kit, Sample Port



**PENTAIR AQUATIC SYSTEMS**

1620 HAWKINS AVE., SANFORD, NC 27330 • (919) 566-8000  
10951 WEST LOS ANGELES AVE., MOORPARK, CA 93021 • (805) 553-5000  
WWW.PENTAIRPOOL.COM

All Pentair trademarks and logos are owned by Pentair or one of its global affiliates. Pentair Aquatic Systems™, Acu-Trol® are trademarks and/or registered trademarks of Pentair Water Pool and Spa, Inc. and/or its affiliated companies in the United States and/or other countries. Unless expressly noted, names and brands of third parties that may be used in this document are not used to indicate an affiliation or endorsement between the owners of these names and brands and Pentair Water Pool and Spa, Inc. Those names and brands may be the trademarks or registered trademarks of those third parties. Because we are continuously improving our products and services, Pentair reserves the right to change specifications without prior notice. Pentair is an equal opportunity employer.

© 2014 Pentair Aquatic Systems. All rights reserved. This document is subject to change without notice.



P/N 700000016 REV. C 3/2014