



## BIOSHIELD® CVP VERTICAL UV DISINFECTION STERILIZER



### UV DISINFECTION SYSTEM

Establishing a bio-secure swimming facility begins at the pool design stage. Low pressure UV systems are a proven solution to harmful waterborne pathogen problems and irritating chloramines. Pentair BioShield Commercial UV systems provide instant protection against Cryptosporidium, Giardia and remove chloramines.

Vertical standing with flanged base, single-end top-loading lamp and quartz sleeve minimize floor space and maximize serviceability.

### STANDARD FEATURES

- Instant protection against Cryptosporidium and other harmful waterborne pathogens.
- Significantly reduces chemical odors within enclosed pool area.
- Conserve Free-Chlorine by as much as 30% compared to medium pressure UV systems.
- Enhanced, state-of-the-art electronic ballast, sized precisely to the lamp's power requirement, ensures optimal UV-C output and maximum "useful lamp life".
- Small footprint: vertical operation reduces required horizontal space. Unit can be installed horizontally if necessary.
- Cost-effective Schedule 80 solvent welded PVC plastic vessels stand up to corrosive Chlorine environments.
- High quality American made low-pressure, Amalgam UV lamps offer up to 12,000 hours of continuous operation.
- Low temperature lamps conserve energy and negate the need for quartz sleeve wiper systems.
- Choice of input/output piping connections.
- Standard sizes available up to 555 GPM and NSF 50 Certified.
- UV Vessel water temperature sensor/alarm – protects vessel from temperatures exceeding 120°F.
- 6-foot power cord and 20-foot lamp cables.



## CONTROL PANEL FEATURES

- Menu driven, digital interface with touch-pad for easy command initiation.
- Incoming AC Voltage Monitor – Alarms when voltage falls outside factory set threshold.
- Digitally displayed, resettable total operating hour meter.
- Individual Lamp Status and Lamp Life Monitor – 72-hour reoccurring alarm triggered upon end-of-useful-lamp-life (12,000 hours).
- Power supply enclosure temperature sensor alarm – Protects internal components from temperatures exceeding 140°F.

- UV Intensity sensor alarm – Monitors UV intensity inside the reactor vessel and measures UV-C lamp output percent (1-100%).
- Output Alarm Relay – 100mA, normally open “Form A” dry contact for enunciation of above alarm conditions to external controller.
- Thermoplastic NEMA 12 enclosure.



## AVAILABLE OPTIONS

- Water Flow Meter – to measure and display UV system water flow rate in either GPM or LPM.
- Ethernet communications port – using supplied map of I/O, allows host controller to monitor individual alarm/lamp conditions via Modbus RTU protocol.
- 4-20mA output port.

## MICROPROCESSOR FEATURES

All NSF-50 BioShield UV system models feature our user-friendly, microprocessor-based controller/monitor. This sophisticated instrumentation features a menu-driven digital interface with touch pad controls for easy command initiation.

## THE PROVEN SOLUTION

Safe and healthy swimming is a matter of clean water and air conditions. Whether you swim in a residential or public pool, poorly maintained water chemistry and air quality can make you sick.

UV has proven to be the solution for dangerous RWI's (Recreational Water Illnesses) and Chloramines (Chemical Irritants). UV Treatment is as natural as sunlight. More specifically, UV-C light is a natural component of the electromagnetic radiation that the Sun emits. Much of the Sun's radiation is absorbed by ozone in the Earth's upper atmosphere, but some UV-C light passes through and acts as a natural disinfectant. UV-C light inactivates exposed microorganisms, including those found in surface waters.

UV systems operate the same way. Inside a UV system, UV lamps emit UV-C light (wavelength range 240-280 nm). Waterborne pathogens in the water circulating through the UV vessel are exposed to the UV-C light for a determined amount of time and become inactivated.

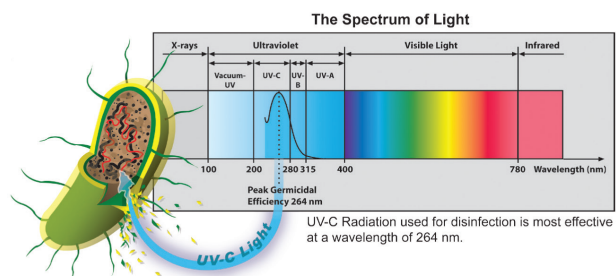
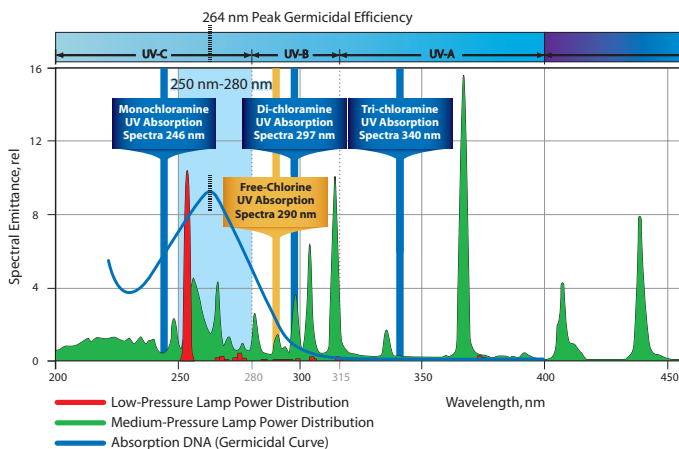

## SOLUTION FOR GERMS THAT CAUSE RWI's

UV is instant germicidal disinfection, Free Chlorine is not. UV disinfection inactivates germs (Cryptosporidium, Giardia and E. Coli.) most commonly associated with RWI's. UV disinfection provides instant (single-pass) treatment unlike Free-Chlorine and ozone. UV systems are a "Green" Technology and deliver multiple benefits contributing to healthy swim water.

### Chlorine Disinfection Is Not Instant

AGENT	Disinfectant Times for Fecal Contaminants in Chlorinated Water*
<b>E. Coli 0157:H7</b> Bacterium	<< 1 minute
<b>Hepatitis A</b> Virus	approximately 16 minutes
<b>Giardia</b> Parasite	approximately 45 minutes
<b>Cryptosporidium</b> Parasite	approximately 15300 minutes (10.6 days)

\* 1 mg/L (1ppm) free chlorine at pH 7.5 and 25° C (77° F)  
 \* These disinfectant times are only for pools that do not use chlorine stabilizers such as cyanuric acid. Disinfection times would be expected to be longer in the presence of a chlorine stabilizer.

### Microorganism Inactivation Chart\*

PATHOGENIC BACTERIA	DOSE RATE
Cholera	6.5mJ/cm <sup>2</sup>
Dysentery	4.2 mJ/cm <sup>2</sup>
E. coli	8.4 mJ/cm <sup>2</sup>
Legionella	4 mJ/cm <sup>2</sup>
Salmonella	10 mJ/cm <sup>2</sup>
PROTOZOAN CYSTS	DOSE RATE
Giardia lamblia	11 mJ/cm <sup>2</sup>
Cryptosporidium	12 mJ/cm <sup>2</sup>
PATHOGENIC VIRUSES	DOSE RATE
Poliovirus	30 mJ/cm <sup>2</sup>
Hepatitis A	21 mJ/cm <sup>2</sup>

\*Based on a 99.9% log reduction

## LOW PRESSURE UV IS THE PROVEN GREEN SOLUTION

Two UV technologies exist: Low-pressure (LP) and Medium-pressure (MP). Both UV technologies inactivate dangerous pathogens and irritating Chloramines but MP UV systems cost almost 3x more to operate than LP. In the past, Medium-pressure UV systems were believed to be more effective than Low-pressure due to MP's high UV-C light output and compact package, but over the years LP UV lamp technology has improved to the point where LP lamps are now 5x more powerful than they were initially. Today, LP UV lamp technology continues to evolve and has significantly narrowed the gap of number of lamps required between MP and LP UV systems. The result is that LP UV systems now cost nearly 3x less to operate than MP UV systems.

LP and MP UV lamps operate very differently. MP UV lamps convert 11-15% of their input electricity into UV-C light. LP UV lamps convert 35-40%, making them much more effective and cost-efficient at germicidal disinfection and Chloramine control.

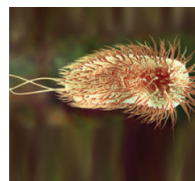

*E. Coli*

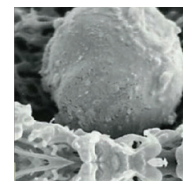

*Cryptosporidium*

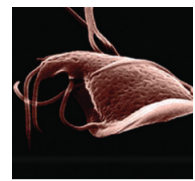

*Giardia*

## MONEY-SAVING FACTS

### Conserve Free-Chlorine

MP UV lamps decay Free-Chlorine which increases operational cost. LP UV lamps are proven to conserve Free-Chlorine by as much as 30%, saving you money.

### Low Heat Output

LP Amalgam lamps operate at 180°F, MP lamps at 1,600°F. The extreme heat generated by MP UV lamps intensifies the problem of quartz sleeve fouling and creates the need for expensive and problematic quartz sleeve wiping systems. This ultimately complicates equipment maintenance. BioShield Amalgam UV lamps operate at a fraction of that heat output and do not require the addition of a quartz sleeve wiping system.

### Longest Lamp-Life

LP UV lamp life of 12,000 hours, outlast MP lamps by as much as 3 times. Even with the need for additional lamps compared to MP, the high cost and short life of MP make LP UV up to 3 times less costly to maintain.

For example: a 288,000 gallon pool using a MP UV system, operating at 800 GPM, and delivering a UV dose to 60 mJ/cm<sup>2</sup>, replaces MP UV lamps annually at a cost of \$1,120 each (\$3,300). Compare that to a LP UV system which replaces 7 lamps annually at a cost of \$160 each (\$1,120). The lamps are oversized at startup to accommodate a 20% degradation during the course of 12,000 hours

## SIZING YOUR BIOSHIELD® CVP UV SYSTEM

- Establishing flow rate requirements** in GPM is critical to selecting the correct UV system for your application.
- Know your UVT (Ultraviolet Light Transmittance) and Target Dose.** Particles suspended in water will absorb or reflect UV, even if the water looks “clear”. UVT is the measure of how much UV-C light transmittance (at 254nm) in water. Pentair has selected 90% UVT as a reasonably conservative value in our sizing charts. Other manufacturers may use a higher UVT% which will greatly overrate their flow capacity compared to that at 90% UVT. The best way to know your UVT is to measure it. Target Dose depends on the intended purpose of the UV reactor. While this can be complicated, the following rules-of-thumb are often used at minimum:

UV Dose	Commercial Application
40 mJ/cm <sup>2</sup>	Inactivation of Cryptosporidium and other chlorine tolerant pathogens
60 mJ/cm <sup>2</sup>	Additional breakdown of Chloramines for greatly improved air and water quality

- Choose your BioShield UV System model.** Using the below chart, select a unit that can treat your system flow at the desired dose. When selecting a port size, be sure the system flow rate will never exceed “Max. Flow for Port Size”.

CVP Model	Lamps/Watts	UV-C Spectrum Output Watts	Max. Flow Rate at 90% UVT 40 mJ/cm <sup>2</sup> (GPM)	Max. Flow Rate at 90% UVT 60 mJ/cm <sup>2</sup> (GPM)	Port Size <sup>2</sup>	Max. Flow for Port Size	Amps Max Load @ 120/230 VAC	UV Vessel Dimensions <sup>1</sup> (A x B x C)	Power Enclosure Dimensions (H x W x D)	Max. PSI
522904	1/130	40	49	33	2"	-	2.1/1.0	57" x Ø6" x 47"	16" x 14" x 8.4"	50
522905	2/130	80	90	60	2"	*64	3.9/2.0	57" x Ø6" x 47"	16" x 14" x 8.4"	50
522918					3"	-				
522919	3/130	120	125	83	3"	-	5.8/2.9	57" x Ø6" x 47"	16" x 14" x 8.4"	50
522907	3/130	120	167	111	3"	*144	5.8/2.9	63" x Ø8" x 47"	16" x 14" x 8.4"	50
522920					4"	-				
522908	4/130	160	227	151	3"	*144	7.5/3.7	63" x Ø8" x 47"	20.2" x 16.3" x 8.4"	50
522921					4"	-				
522922	5/130	200	272	181	4"	*251	9.4/4.7	63" x Ø8" x 47"	24.6" x 20.2" x 10.6"	50
522935					6"	-				
522910	6/130	240	365	244	4"	*251	11.2/5.6	68" x Ø10" x 51"	24.6" x 20.2" x 10.6"	50
522923					6"	-				
522924	7/130	280	430	287	6"	-	13.3/6.5	68" x Ø10" x 51"	24.6" x 20.2" x 10.6"	50
522912	7/130	280	492	328	6"	-	13.3/6.5	75" x Ø12" x 51"	24.6" x 20.2" x 10.6"	50
522913	8/130	320	555	369	6"	-	15.0/7.5	75" x Ø12" x 51"	30.5" x 24.1" x 12.6"	50

<sup>1</sup> Vessel dimension “C” represents clearance requirement for glassware maintenance.

<sup>2</sup> When selecting a port size, be sure the system flow rate will never exceed “Max. Flow for Port Size”

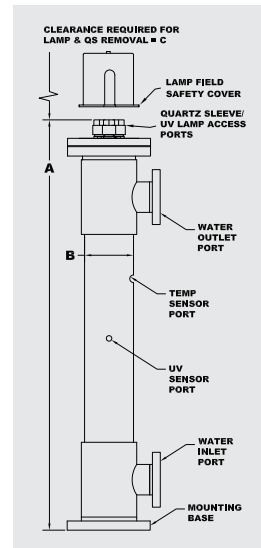
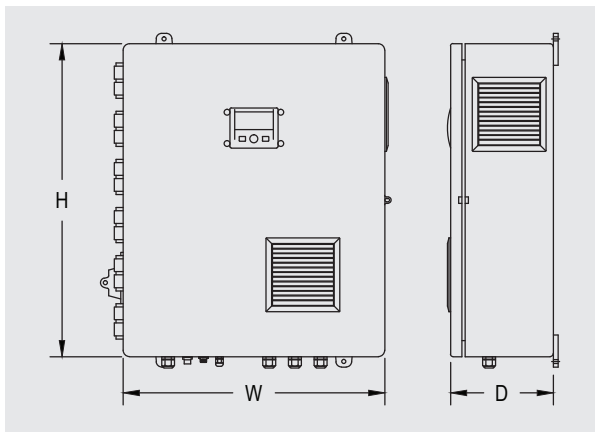

For replacement parts please call Technical Service at 1-800-831-7133.

1620 HAWKINS AVE, SANFORD, NC 27330 800.831.7133 WWW.PENTAIRCOMMERCIAL.COM

All Pentair trademarks and logos are owned by Pentair or one of its global affiliates. BioShield® is a registered trademark and/or trademark of Pentair Water Pool and Spa, Inc. and/or its affiliated companies in the United States and/or other countries. Because we are continuously improving our products and services, Pentair reserves the right to change specifications without prior notice. Pentair is an equal opportunity employer.

2/18 Part # PCA-107 ©2018 Pentair Water Pool and Spa, Inc. All rights reserved.