



Model 2535S and Model 2545S

HYPRO®

Form L-1500
Rev. B

Installation, Operation, Repair and Parts Manual

Description

 **California Proposition 65 Warning** -- This product and related accessories contain chemicals known to the State of California to cause cancer, birth defects or other reproductive harm.

The Hypro 2535 and 2545 triplex plunger pumps are designed for durability and top performance. The self-adjusting, spring-loaded V-packings maintain constant high pressure seal compression. Operators will also notice a decrease in the effects of abuse caused by cold start-up and intermittent operation with the robust crankshaft, bearings, and bronze connecting rod.

Operators can also expect an extended life and lower costs from the Model 2535S and Model 2545S. The 316 stainless steel head and two-piece manifold are built to

resist washout and corrosion, allowing the highest quality solutions to be pumped with optimum performance. Seal life has also been improved. The stepped plunger rod between the plunger guide and oil seal will eliminate seal failure due to plunger rod wear. V-packings have also been used to extend seal and plunger life.

Best of all, the innovative design offers operators easy service access by bringing all of the maintenance towards the front.



Flow Rate: 38 gpm (Model 2535S)
47 gpm (Model 2545S)

Max. Pressure: 1200 psi

Shaft Diameter: 35mm

Max. Speed: 800 rpm

Ports: 1-1/2" Inlet
1" Outlet

Weight: 141 lbs.

General Safety Information

- WARNING: Use a pressure relief device on the discharge side of the pump to prevent damage from pressure buildup when the pump discharge is blocked or otherwise closed and the power source is still running. For trigger gun operation, or where discharge is frequently shut off, pressure unloader valves are recommended. FAILURE TO FOLLOW THIS WARNING MAY RESULT IN PERSONAL INJURY AND/OR PROPERTY DAMAGE AND WILL VOID THE PRODUCT WARRANTY.**
- WARNING: Do not pump flammable or explosive fluids such as gasoline, fuel oil, kerosene, etc. Do not use in explosive atmospheres. The pump should be used only with liquids that are compatible with the pump component materials. Failure to follow this warning may result in personal injury and/or property damage and will void the product warranty.**
- Do not run the pump faster than maximum recommended speed.
- Do not pump at pressures higher than the maximum recommended pressure.
- The maximum liquid temperature is 160°F for the 2535S and 2545S.
- Make certain that the power source conforms to the requirements of your equipment.
- Provide adequate protection in guarding around the moving parts such as the shaft and pulleys.
- Disconnect the power before servicing.
- Release all pressure within the system before servicing any component.
- Drain all liquids from the system before servicing any component.
- Secure the discharge lines before starting the pump. An unsecured line may whip, causing personal injury and/or property damage.
- Check the hose for weak or worn condition before each use. Make certain that all connections are tight and secure.
- Periodically inspect the pump and the system components. Perform routine maintenance as required. (See Maintenance section.)

WARNING: RISK OF ELECTRIC SHOCK!

To reduce the risk of electric shock, adequately ground the electric motor to a grounded metal raceway system, or use a separate grounding wire that is connected to bare metal on the motor frame or to the grounding screw located inside motor terminal box; or ground by other suitable means. Refer to the most recent National Electric Code (NEC) Article 250 (Grounding) for additional information. **ALL WIRING SHOULD BE PERFORMED BY A QUALIFIED ELECTRICIAN.**

WARNING: Do not handle a pump or pump motor with wet hands or when standing on a wet/damp surface or in water.

- Use only pipe, hose and fittings rated for the maximum psi rating of the pump. If an unloader is used, then the pipe should be rated for pressure at which the unloader operates.
- Do not use these pumps for pumping water or other liquids for human or animal consumption.

Unloader Valve Safety Information

- Always size your unloader valve to match the capabilities of your system for pressure (psi) and volume (gpm).
- In rigid-piped systems, a pulsation dampener or accumulator **MUST** be installed in the system. Select a dampener which conforms to the rated capacity.
- Never replace the main spring with one of heavier tension to increase pressure. Never add washers to increase spring tension.
- Always replace safety shield caps.
- Secure all locking devices to eliminate the unloader from vibrating out of adjustment during operation.

Belt/Pulley Drive Installation

This pump was designed for rotation in one direction, which is toward the pump head when looking at the top of the pulley. There is a rotation direction sticker located on crankcase bearing cover. Reverse rotation is acceptable if the oil level is increased by 1/2 quart.

For determining proper pulley sizes, use the formula below as a guideline and use "A" or "B" section belts.

$$\frac{\text{MOTOR RPM}}{\text{PUMP RPM}} = \frac{\text{FLOW (@RATED SPEED)}}{\text{FLOW (DESIRED)}} = \frac{\text{PUMP PULLEY DIA.}}{\text{MOTOR PULLEY DIA.}}$$

EXAMPLE: : Use a 1725 rpm electric motor to drive the pump at 800 rpm.

A typical pulley diameter on the motor is 7.25 inches. The pump pulley diameter can be determined from the formula above:

$$\frac{1725}{800} = \frac{\text{PUMP PULLEY DIAMETER}}{7.25 \text{ INCHES}}$$

$$\frac{1725 \times 7.25 \text{ INCHES}}{800} = 15.6 \text{ INCHES}$$

1. Install the pulley or bushing/sheave combination (See Figure 1) onto the pump and motor shaft. Mount the pump next to the motor making sure the pulleys are lined up properly. Use a straightedge as shown in Figure 2. Rotate to check for runout and bent shafts.
2. Install belt(s) and use slots in the pump mounting rails to tighten the belts. Make sure the belts have proper tension. Belts that are too tight will cause bearing wear, and belts that are too loose will cause slipping. (See Figure 3.)

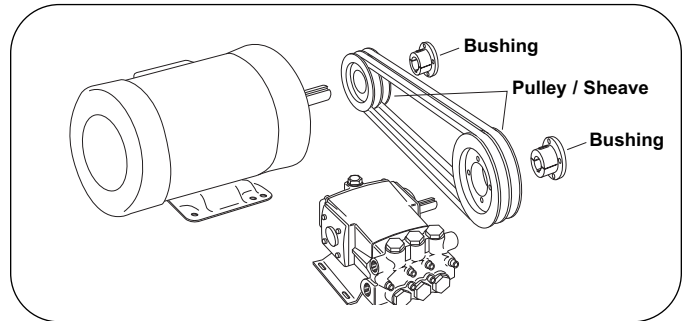

Figure 1

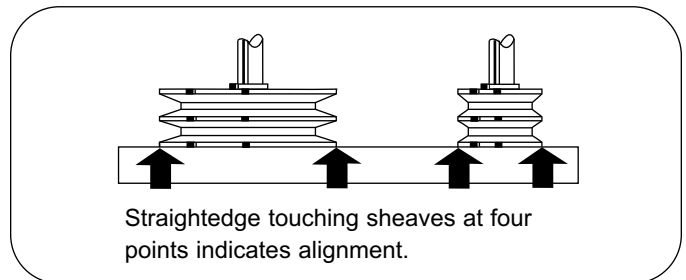

Figure 2

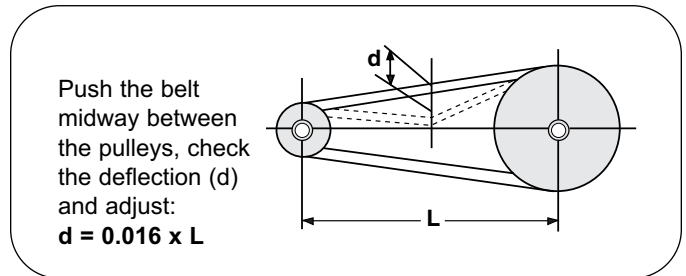

Figure 3

System Installation

1. In general, select an adequate size drive unit to avoid overloading. Avoid unnecessary restrictions in the line such as elbows, check valves, and all extraneous curves and bends.
2. Avoid using a looped section which might permit air to become trapped.
3. Use pipe joint sealant on the pipe threads to assure airtight connections.
4. **Selection of the right type and size of hose is vital to good performance. Be sure to hook the lines to the proper ports on the pump.**
5. Always use genuine suction hose of at least one size larger than the inlet port of the pump. If the suction (inlet) hose is more than four feet long, use the next larger size.
6. Use one or two braid reinforced hose to prevent collapse of suction line.
7. Use only approved, high pressure hose on the discharge side, and make sure all connections are tight.

NOTE: Use only pipe, fittings, accessories, hose, etc. rated for the maximum pressure rating of the pump.

Pump

1. Before installing the pump, clean all fittings and hoses.
2. Rotate the pump by hand to make sure it turns freely.
3. Make sure that all hose connections are tight and use the proper size fittings that are capable of safe operation.

Warning: The pumps are shipped from the factory without Hypro oil. Hypro recommends changing oil after 40 hours of break-in operation and every three months or 500 hours, whichever comes first. Use Hypro Oil (P/N 2160-0047). If not available, use SAE 30 weight non-detergent motor oil. Crankcase capacity: 4.5 Quarts

Discharge Side Installation

From the pump to the discharge hose, the following accessories are recommended: a dampened pressure

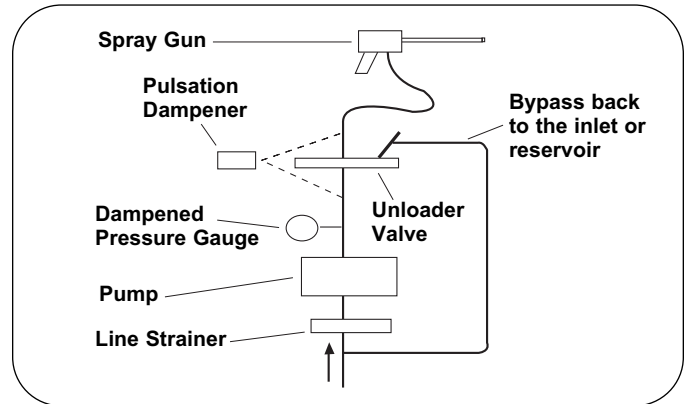

Figure 4

gauge with a face pressure double the maximum operating pressure, an unloader valve, a pulsation damper, an optional pressure gauge to monitor unloader, and discharge hose.

Accessories such as an unloader valve, a pressure gauge, a pulsation dampener - should be installed as close to the pump as possible. A hose must be used right after the accessories. If solid piping is used, a two to four foot section of hose must be installed between the accessories and the piping.

Inlet Side Installation

From the source of liquid to the pump, the following components are recommended: a shut-off valve, a bypass return tee from the unloader, a line strainer, and a compound pressure gauge.

Inlet Water Supply

Inlet filters should be an 80 mesh screen. Only use flexible hose. Do not use rigid pipe. Optimum pump performance is obtained with a positive lead on the inlet - 15 to 20 psi is ideal - but simply flooded is adequate.

Operation

WARNING: DO NOT pump flammable or explosive liquids such as gasoline, kerosene, etc. DO NOT pump corrosive or abrasive liquids because these will cause rapid wear or deterioration of plungers, valves and seals in the pump. The pump should be used only with liquids compatible with pump component materials. Do not exceed the maximum specified rpm and pressure. Observe the lubrication instructions. Failure to follow this warning will void the product warranty.

Lubrication

Before running the pump, check the oil level using the dipstick. Use Hypro Oil (P/N 2160-0047). Hypro oil is a specially-formulated, high grade, SAE 30 weight non-detergent motor oil, formulated to prolong pump life.

The crankcase capacity for these pumps is 4.5 quarts.

Priming the Pump

To prime the pump, adjust the unloader valve to its lowest pressure setting. After starting the pump, open and close the gun to aid priming and to clear the valves of air. If the pump does not prime within a few seconds, stop the motor and inspect the installation for suction line leaks and obstructions. In general, keep suction lift to a minimum and avoid unnecessary bends in the suction line. The unloader valve must be readjusted after the prime has been obtained.

Care of the Pump

Generally, after each use, flush the pump with a neutralizing solution for the liquid pumped. Follow with a clear water rinse. For storage under freezing conditions, flush the pump with a 50% mixture of automotive antifreeze and water.

VALVE SERVICE

DISASSEMBLY

1. Remove (6) 41mm hex valve plug (Fig. 5).
2. Remove the coil spring and thread a M10mm bolt into valve assembly (Fig. 6). Use a pliers to grip the bolt and remove valve assembly (Fig. 7). If resistance is encountered, gently rock bolt until valve comes free.
3. After removing, threading bolt more deeply into the assembly will separate the components.

REASSEMBLY

1. Inspect components and replace worn items as necessary.
2. Assemble valve cage, spring retainer, spring, disc, and valve seat by snapping together (Fig. 8).
3. Thread M10 bolt into assembly for installation.
4. Lubricate outer o-ring, back-up ring and walls of valve chamber. Install valve assembly squarely into the chamber. Remove M10 bolt.
5. Examine valve plug components and replace if worn. Lubricate back-up ring and o-ring before installing on valve cap to prevent damage. Install back-up ring first and then o-ring.
6. Place the spring over the top of the spring retainer.
7. Apply anti-seize compound to the threads of the valve cap and carefully thread it into the manifold. Torque to specifications.
(See Torque Specification Chart on Page 10.)

WARNING: Anti-seize must be applied to all valve caps to avoid the galling of components.



Figure 5



Figure 6



Figure 7



Figure 8

REMOVING THE DISCHARGE MANIFOLD

1. Using a 10mm hex allen wrench, remove (8) socket head cap screws (Fig. 9).
2. While supporting manifold, tap backside of discharge manifold with soft mallet, removing inlet manifold (Fig. 10).
3. Remove o-rings from the interior face of the inlet manifold.

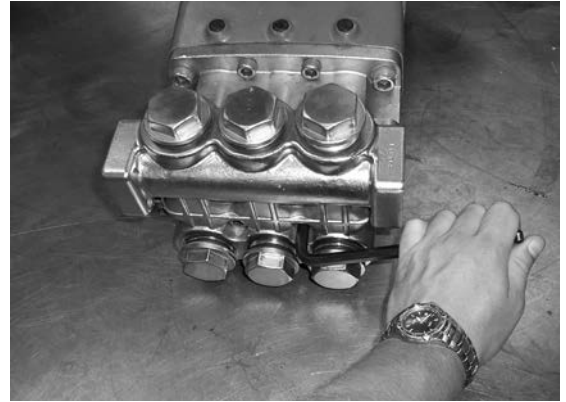

Figure 9

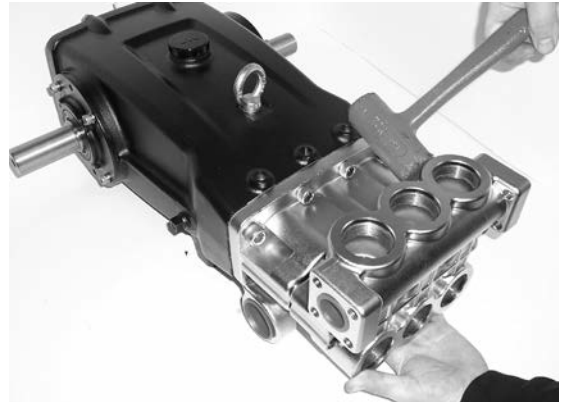

Figure 10

REMOVING THE INLET MANIFOLD

1. Using a 12mm hex allen wrench, remove (4) outer socket head cap screws. Using 10 mm hex allen wrench, remove (4) inner socket head cap screws (Fig. 11).
2. While supporting manifold, tap rear of inlet manifold with soft mallet and gradually work from pump. If necessary, use flat head screwdrivers to gently pry manifold off (Fig. 12).



Figure 11



Figure 12

PACKING SERVICE

DISASSEMBLING THE PACKINGS

1. Place inlet and discharge manifold spacer side up on work surface.
2. Remove the spacer. If spacer is stuck, two screwdrivers may be used on opposite sides to gently pry it out (Fig. 13).
3. Remove spring, spreader, packings and packing retainer from inlet manifold (Fig. 14).
4. Reinstall inlet manifold using proper torque specifications and torquing sequence. Add anti-seize to all bolts prior to installation. (See Torque Specification Chart on page 10.)
5. Inspect components and replace worn items as necessary. It is recommended to replace spacer o-rings and back-up rings at this time.
6. Lubricate packing cylinder and reinstall packing retainer.
7. Fit the packings together. Lightly lubricate the outside of the packings and insert, groove up, into the inlet manifold. Turn the crankshaft. Use the spreader and spring to help guide packings around the plunger and into the manifold until seated properly. If packings are tight, they can be started by tapping them into the manifold using the spreader, a 1.5" PVC pipe against the spreader, and a soft mallet.
8. Reinstall spreader so it meshes with packings; then install spring.
9. Lubricate spacer o-rings and back-up rings and install on spacer. Squarely reinstall packing spacer taking care not to damage o-rings.
10. Reinstall 3 o-rings on the interior face of the inlet manifold. Grease may be applied to hold o-rings in place.
11. Reinstall discharge manifold using proper torque specifications and torquing sequence. **Add anti-seize to all bolts prior to re-installation.** (See Torque Specification Chart on page 10.)

REMOVING AND INSTALLING OIL SEALS

1. Remove the seal retainer, wick, plunger retainer, plunger, washer, slinger, and insert. If plunger is not loose, reassemble the plunger retainer a few threads on the stud and tap with a soft mallet until loose (Fig. 15).
2. The oil seal can be removed from the bottom side of the insert using a reverse pliers, or tapped out with a punch and hammer from the plunger side of the insert.
3. If the studs attached to the plunger rod have become loose, remove and buff clean. Reinstall to the plunger rod using high strength threadlocker.
4. Reinstall oil seal by lubricating and pressing into insert. Replace o-ring.
5. Make sure washer is seated properly in the crankcase. Place insert in crankcase and seat in place using the handle of a soft mallet.
6. Install the plunger by sliding the slinger in place, cupped side toward the front, followed by the plunger and washer. Lubricate o-ring and back-up ring. Apply medium strength threadlocker to the plunger retainer and torque to specifications.

(See Torque Specification Chart on page 10.)



Figure 13



Figure 14



Figure 15

Model 2535S and Model 2545S

Ref. No.	Qty. Req'd	Part No.	Description
1	1	0100-2535A	CRANKCASE
2	2	6031-0438	DECAL
3	2	1600-0072	DOWEL PIN
4	3	2300-0041	PLUG, 1/4" NPT
5	1	2406-0040	PLUG, PIPE
6	3	2102-0042	OIL SEAL
7	3	0714-2535	INSERT (Model 2535S)
7	3	0714-2545	INSERT (Model 2545S)
8	3	1720-0232	O-RING
9	3	2270-0101	WASHER
10	2	1510-0110	BASE
11	4	2205-0018	STUD
12	4	2270-0102	WASHER
13	4	2260-0047	LOCKWASHER
14	4	2250-0089	NUT
15	2	2210-0147	BOLT
16	2	2250-0090	NUT
17	2	2270-0103	WASHER
18	3	3500-0072	PLUNGER ROD
19	3	2270-0104	SLINGER (Model 2535S)
19	3	2270-0126	SLINGER (Model 2545S)
20	3	3500-0073	PLUNGER (Model 2535S)
20	3	3500-0075	PLUNGER (Model 2545S)
21	3	2205-0019	STUD
22	3	2270-0105	WASHER
23	3	1630-0002	PLUNGER NUT
24	3	1720-0233	O-RING
25	3	1760-0014	BACK-UP RING
26	3	1600-0073	WRIST PIN
27	3	0500-2535	CONNECTING ROD ASSY
27-D	3	N/A	ROD
27-F	6	N/A	DOWEL PIN
27-C	3	N/A	RETAINING PLATE
27-B	6	N/A	WASHER
27-A	6	N/A	BOLT
27-E	3	N/A	BEARING
28	2	2029-0015	BEARING
29	1	0501-2535	CRANKSHAFT
30	1	1610-0063	KEY (M10x8x70)
31	2	2102-0040	OIL SEAL
32	2	0700-2535	BEARING COVER
33	2	1720-0234	O-RING
34	2	1430-0030	SHIM
35	8	2220-0108	BOLT
36	8	2260-0048	LOCKWASHER
37	8	2270-0107	WASHER
38	1	0701-2535	COVER
39	4	2220-0109	BOLT
40	4	2260-0049	LOCKWASHER
41	4	2270-0108	WASHER
42	1	0702-2535	REAR COVER
43	1	1720-0235	O-RING
44	8	2220-0110	BOLT
45	8	2260-0050	LOCKWASHER
46	8	2270-0109	WASHER
47	1	2630-0019	DIPSTICK
48	1	2406-0039	DRAIN PLUG 1/4"-18 NPT
49	1	2630-0020	OIL CAP

Plunger Kit No. 3430-0638 (Model 2535S) / 3430-0728 (Model 2545S):

Consists of: (1) Ref. 24 O-Ring, (1) Ref. 25 Back-up Ring, (1) Ref. 19 Slinger, (1) Ref. 22 Washer, (1) Ref. 20 Plunger, & (4) Anti-Seize Tubes

Packing Kit No. 3430-0639 (Model 2535S) / 3430-0729 (Model 2545S):

Consists of: (3) Ref. 62 Low Pressure Seal, (6) Ref. 65 Packing, & (4) Anti-Seize Tubes

Valve Kit No. 3430-0640 (Model 2535S) / 3430-0730 (Model 2545S):

Consists of: (6) Ref. 73 Valve Assembly, (6) Ref. 77 Back-up Ring, (6) Ref. 78 O-Ring, & (3) Anti-Seize Tubes

Ref. No.	Qty. Req'd	Part No.	Description
50	1	2214-0001	EYE BOLT
51	1	2270-0110	WASHER
52	1	2850-0010	OIL PAN
53	2	2270-0111	WASHER
54	2	2220-0111	BOLT
55	3	1700-0211	WICK (Model 2535S)
55	3	1700-0231	WICK (Model 2545S)
56	3	1830-0175	SEAL RETAINER (Model 2535S)
56	3	1830-0182	SEAL RETAINER (Model 2545S)
57	1	0200-2535	INLET MANIFOLD (Model 2535S)
57	1	0200-2545	INLET MANIFOLD (Model 2545S)
58	3	1720-0239	O-RING
59	4	2220-0112	BOLT
60	2	2220-0113	BOLT
61	2	2220-0114	BOLT
62	3	2102-0041	LOW PRESSURE SEAL (2535S)
62	3	2102-0045	LOW PRESSURE SEAL (2545S)
63	3	1410-0117	SPACER (Model 2535S)
63	3	N/A	SPACER (Model 2545S)
64	3	1830-0176	PACKING RETAINER
65	6	2140-0004	PACKING (Model 2535S)
65	6	2140-0005	PACKING (Model 2545S)
66	3	1830-0177	SPREADER (Model 2535S)
66	3	1830-0181	SPREADER (Model 2545S)
67	3	1900-0167	SPRING (Model 2535S)
67	3	1900-0181	SPRING (Model 2545S)
68	3	1410-0118	SPACER (Model 2535S)
68	3	1410-0124	SPACER (Model 2545S)
69	6	1720-0240	O-RING (Model 2535S)
69	6	1720-0264	O-RING (Model 2545S)
70	6	1760-0015	BACK-UP RING (Model 2535S)
70	6	1760-0018	BACK-UP RING (Model 2545S)
71	1	0201-2535	DISCHARGE MANIFOLD (2535S)
71	1	0201-2545	DISCHARGE MANIFOLD (2545S)
72	8	2220-0115	BOLT
73	6	3400-0169	VALVE ASSY (Model 2535S)
73	6	3400-0170	VALVE ASSY (Model 2545S)
73-A	6	N/A	VALVE CAGE
73-B	6	N/A	SPRING
73-C	6	N/A	DISC
73-D	6	N/A	VALVE SEAT
74	6	1720-0241	O-RING (Model 2535S)
74	6	1720-0265	O-RING (Model 2545S)
75	6	1760-0016	BACK-UP RING (Model 2535S)
75	6	1760-0019	BACK-UP RING (Model 2545S)
76	6	2404-0357	VALVE CAP
77	6	1760-0017	BACK-UP RING
78	6	1720-0242	O-RING
79	6	1900-0169	SPRING
80	6	3200-0062	SPRING RETAINER

Packing Rebuild Kit No. 3430-0641 (Model 2535S) / 3430-0731 (Model 2545S):

Consists of: (3) Ref. 58 O-Ring, (6) Ref. 69 O-Ring, (6) Ref. 70 Back-up Ring, (3) Ref. 64 Packing Retainer, (3) Ref. 62 Low Pressure Seal, (6) Ref. 65 Packing, & (4) Anti-Seize Tubes

Valve Seal Kit No. 3430-0642 (Model 2535S) / 3430-0732 (Model 2545S):

Consists of: (6) Ref. 74 O-Ring, (6) Ref. 78 O-Ring, (6) Ref. 75 Back-up Ring, (6) Ref. 77 Back-up Ring, & (3) Anti-Seize Tubes

Plunger Seal Kit No. 3430-0643 (Model 2535S) / 3430-0733 (Model 2545S):

Consists of: (3) Ref. 24 O-Ring, (3) Ref. 25 Back-up Ring, (3) Ref. 19 Slinger, (3) Ref. 22 Washer, & (4) Anti-Seize Tubes

Rod Oil Seal Kit No. 3430-0644 (Model 2535S) / 3430-0734 (Model 2545S):

Consists of: (3) Ref. 55 Wick, (3) Ref. 8 O-Ring, & (3) Ref. 6 Oil Seal, & (4) Anti-Seize Tubes

Mounting Kit No. 3430-0645 (Both Models):

Consists of: (2) Ref. 10 Base, (4) Ref. 11 Stud, (2) Ref. 15 Bolt, (4) Ref. 14 Nut, (2) Ref. 16 Nut, (4) Ref. 13 Lockwasher, (4) Ref. 12 Washer, & (2) Ref. 17 Washer

Performance Chart

Model	RPM	GPM	PSI	HP
2535S	800	38	1200	31.2
2545S	800	47	1200	36.1

Torque Specifications

Part Description	Ref. No.	Torque
Valve Cap **	95	110 ft.lbs.
Inlet Manifold Bolts **	74, 75, 76	40 ft.lbs.
Discharge Manifold Bolts **	87	30 ft.lbs.
Plunger Retainer *	23	18 ft.lbs.
Rear Cover Bolts	50	10 ft.lbs.
Bearing Cover Bolts	38	10 ft.lbs.
Connecting Rod Bolts	32	32 ft.lbs.

* Use Medium Strength Threadlocker on Assembly

** Use Anti-Seize on Assembly

Note: Use the following torquing pattern when mounting the Inlet and Discharge Manifold

8	1	3	5
7	4	2	6

Maintenance Schedule

Check	Daily	Weekly	40 hrs.	500 hrs.	1500 hrs.
Clean Filters	X				
Oil Level	X				
Oil Leaks	X				
Water Leaks	X				
Belts, Pulleys		X			
Plumbing		X			
Initial Oil Change			X		
Oil Change*				X	
Seal Service					X
Valve Service					X
Accessories					X

*If other than HYPRO pump oil is used, change frequency should be increased to every 250 hours.

Note: Maintenance cycles will vary by system design. If a negative change in system performance is noticed, promptly check pump and review checklist items.

Troubleshooting

Symptom	Probable Cause(s)	Corrective Action
Pump runs, but produces no flow.	Pump is not primed.	Flood suction, then restart pump.
Pump fails to prime.	Air is trapped inside pump.	Disconnect discharge hose from pump. Flood suction hose, restart pump, and run pump until all air has been evacuated.
Pump loses prime.	Air leak in suction hose or inlet fittings.	Remove suction hose and test for leaks by pressurizing hose with water.
Chattering noise.		Make sure thread sealant has been used on all fittings.
Pressure fluctuates.	Suction line is blocked, collapsed or too small.	Remove suction line and inspect it for a loose liner or debris lodged in hose. Avoid all unnecessary bends. Do not kink hose.
	Clogged suction strainer.	Clean strainer.
Low pressure at nozzle.	Unloader valve is bypassing.	Make sure unloader is adjusted properly and bypass seat is not leaking.
	Incorrect or worn nozzle.	Make sure nozzle is matched to the flow and pressure of the pump. If the nozzle is worn, replace.
	Restricted intake.	Refer to above priming information.
Pressure loss in general.	Screen clogged.	Check the screen for debris and clean or replace.
	Inlet size too small.	Make sure it is big enough.
	Worn or clogged valves are stuck due to corrosion.	Inspect valves for corrosion, wear, pitting and debris, and replace if necessary.
	Unloader bypassing.	Plumbed wrong. See if the flow is diverting out of the bypass line.
	System leaks.	Check for leaks.

Note: Cavitation Will Damage Your Pump!

Cavitation occurs when an inadequate amount of fluid is available for feeding the pump.

If it takes the supply water noticeably longer to fill the test container to the gallons per minute that your system requires, your pump could be experiencing cavitation. Cavitation can severely damage seals, pistons and valves and will shorten the life of all components in the hydraulic system.

To Avoid Cavitation:

- Keep the size of the suction line as large as possible, preferably the same size (or larger) as the inlet port.
- Use high-capacity, clean line strainers.
- Install a fitting at the suction side so you can check the vacuum periodically. The vacuum should not exceed 2-3 inches of Hg to obtain the best operation.
- Protect the pump from overheating.
 - Protect it from direct sunlight in hot weather.
 - Maintain adequate ventilation.
 - Keep lubricating fluids clean and at full levels.
- Protect the pump from severe cold by covering or operating indoors.
- Make sure the pump is secure and can't move around.
- Control the pressure with unloader valves and balanced relief valves. To prevent pressure spikes, don't over tighten the control valves.
- Use a pulsation dampener. Soft hose works well.
- To avoid vacuum leak, prevent the system from flowing against gravity.
- In a gravity-fed system, keep the rate of flow from gravity the same (or more) as the feed requirements of the pump.

Limited Warranty on Hypro Plunger Pumps

Hypro warrants to the original purchaser of its products (the "Purchaser") that oil crankcase plunger pumps will be free from defects in material and workmanship under normal use for the period of five (5) years, and accessories will be free from defects in material and workmanship under normal use for the period of ninety (90) days. In addition, Hypro warrants to the purchaser all stainless steel pump manifolds will be free from defects in material and workmanship under normal use and from damage resulting from environmental conditions for the life of the pump.

"Normal use" does not include use in excess of recommended maximum speeds, pressures, vacuums and temperatures, or use requiring handling of fluids not compatible with component materials, as noted in Hypro product catalogs, technical literature, and instructions. This warranty does not cover freight damage, freezing damage, normal wear and tear, or damage caused by misapplication, fault, negligence, alterations, or repair that affects the performance or reliability of the product.

THIS WARRANTY IS EXCLUSIVE. HYPRO MAKES NO OTHER WARRANTY, EXPRESS OR IMPLIED, INCLUDING BUT NOT LIMITED TO ANY WARRANTY OF MERCHANTABILITY OR FITNESS FOR A PARTICULAR PURPOSE.

Hypro's obligation under this warranty is, at Hypro's option, to either repair or replace the product upon return of the entire product to the Hypro factory in accordance with the return procedures set forth below. **THIS IS THE EXCLUSIVE REMEDY FOR ANY BREACH OF WARRANTY.**

IN NO EVENT SHALL HYPRO BE LIABLE FOR ANY INCIDENTAL OR CONSEQUENTIAL DAMAGES OF ANY KIND, WHETHER FOR BREACH OF ANY WARRANTY, FOR NEGLIGENCE, ON THE BASIS OF STRICT LIABILITY, OR OTHERWISE.

Return Procedures

All pumps or products must be flushed of any chemical (ref. OSHA Section 0910.1200 (d)(e)(f)(g)(h)) and hazardous chemicals must be labeled before being shipped* to Hypro for service or warranty consideration.

Hypro reserves the right to request a Material Safety Data sheet from the Purchaser for any pump or product Hypro deems necessary. Hypro reserves the right to "disposition as scrap" pumps or products returned which contain unknown substances, or to charge for any and all costs incurred for chemical testing and proper disposal of components containing unknown substances. Hypro requests this in order to protect the environment and personnel from the hazards of handling unknown substances.

For technical or application assistance, call the **Hypro Technical/Application number: 800-445-8360**, or send an email to: **technical@hypropumps.com**. To obtain service or warranty assistance, call the **Hypro Service and Warranty number: 800-468-3428**; or send a fax to the **Hypro Service and Warranty FAX: 651-766-6618**. Be prepared to give Hypro full details of the problem, including the following information:

1. Model number and the date and from whom you purchased your pump.
2. A brief description of the pump problem, including the following:
 - Liquid pumped. State the pH and any non-soluble materials, and give the generic or trade name.
 - Temperature of the liquid and ambient environment.
 - Suction lift or vacuum (measured at the pump).
 - Discharge pressure.
 - Size, type, and mesh of the suction strainer.
 - Drive type (gas engine/electric motor, direct/belt drive, tractor PTO) and rpm of pump.
 - Viscosity (of oil, or other than water weight liquid).
 - Elevation from the pump to the discharge point.
 - Size and material of suction and discharge line.
 - Type of spray gun, orifice size, unloader/relief valve.

Hypro may request additional information and may require a sketch to illustrate the problem. Contact the factory to receive a return material authorization before sending the product. All pumps returned for warranty work should be sent shipping charges prepaid to:

HYPRO / PENTAIR
Attention: Service Department
375 Fifth Avenue NW
New Brighton, Minnesota 55112

* Carriers, including U.S.P.S., airlines, UPS, ground freight, etc., require specific identification of any hazardous materials being shipped. Failure to do so may result in a substantial fine and/or prison term. Check with your shipping company for specific instructions.

