



FLUORIDE WATER FILTER SYSTEM
PF6-P



TABLE OF CONTENTS

PRODUCT OPERATION AND SPECIFICATIONS	3
COMPLETE PARTS LIST	3
INSTALLATION OVERVIEW.....	4
PRE-INSTALLATION.....	5
FLUORIDE FILTER SOAK.	6
FLUORIDE FILTER WASH.....	7
SEDIMENT FILTER INSTALLATION.....	8
FLUORIDE WATER FILTER SYSTEM TANK INSTALLATION.....	9
BYPASS VALVE OPERATIONS	10
MAINTENANCE	11
TROUBLESHOOTING.....	12
PRODUCT WARRANTY AND REGISTRATION FORM.....	13

IMPORTANT INFORMATION

- Read these instructions carefully and determine the location of all system components before beginning installation.
- Check all applicable plumbing, building, and electrical codes for installation compliance.
- Install the system on the main water supply.
- The use of plumber's tape and/or pipe thread seal paste will be needed on all threaded connections.
- To condition all water in the home, install the system close to the water supply inlet, and upstream of all other plumbing connections, except outside water pipes. Outside faucets should remain on unfiltered water.

WARNING

Installing this system in a metal (conductive) plumbing system, i.e., copper or galvanized metal, will interrupt the continuity of the plumbing system and grounding source in some homes. If your home's electrical appliances are grounded through the plumbing system, you will need to install a bypass that consists of the same material as the existing plumbing or a grounded "jumper wire" to bridge the equipment and re-establish the contiguous conductive nature of the plumbing before using this Pentair system. Failure to do so can result in errant electricity from improperly grounded appliances or potential galvanic activity in the plumbing system, which could increase the risk of fire or injury while using your home appliances. Please consult a licensed electrician before attempting to install.

CAUTION

When adding a filtration/softening system to homes/buildings supplied by well water, the system should be installed following the pressure tank. **DO NOT USE this system for pneumatic or hydropneumatic applications. If you are using a booster pump, then install this system following the booster pump.** If you have questions, please call customer service.

Customer Service Contact Information Section

Homeowners Phone: 877.842.1635

Professionals Phone: 877.842.1635

PRODUCT OPERATION AND SPECIFICATIONS





Specification Description	PF6-P
Max Flow Rate	15 GPM
Minimum Working Pressure	25 PSI
Maximum Working Pressure	80 PSI
Maximum Vacuum	5 inch/127 mm Hg
Operating Temperatures	36°F - 120°F
pH Range	6 - 11

COMPLETE PARTS LIST

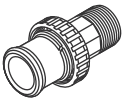
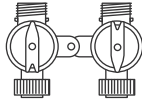
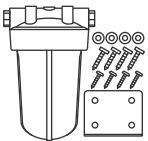

Note

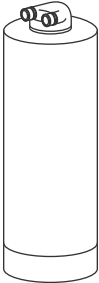
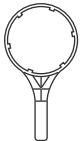
The parts supplied are intended to accommodate a variety of water supply lines. Additional fittings may be needed to fit to your plumbing. Visit pentair.com to view our full line of installation kits.

Part	Description	Qty.	Part	Description	Qty.
	1" Plastic Male NPT Assembly: V3007-04 1" Plastic Male NPT Assembly (2); O-Rings (2), Split Rings (2), and Connectors (2)	1		Bypass Valve: In/Out Bypass Valve with Red Arrow Handles	1
	Pre-Filter System: PP5 Big Blue Pre-Filter Housing, Mounting Bracket, Phillips Head Screws (4), BoltHead Screws (4), and Washers (4)	1		Hose Bib Assembly	1
	Sediment Filter: PC40-15 Micron Poly-Spun Sediment Filter	1		Whole House Fluoride Filter	1
	Pre-Filter Wrench	1			
	Non-Abrasive Auto Wax: 4 oz. Bottle	1			



Note

Drawings not to scale.

INSTALLATION OVERVIEW

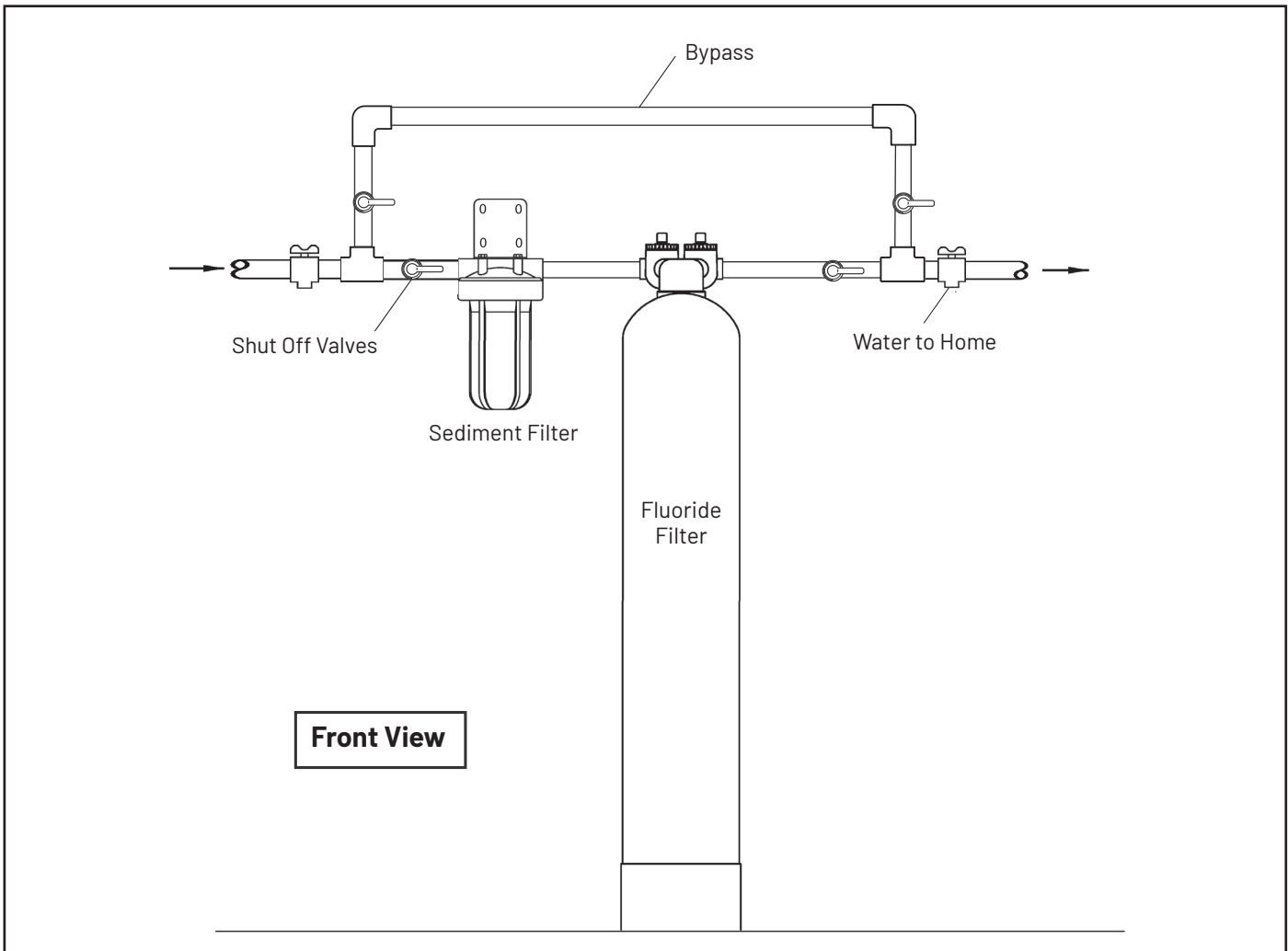
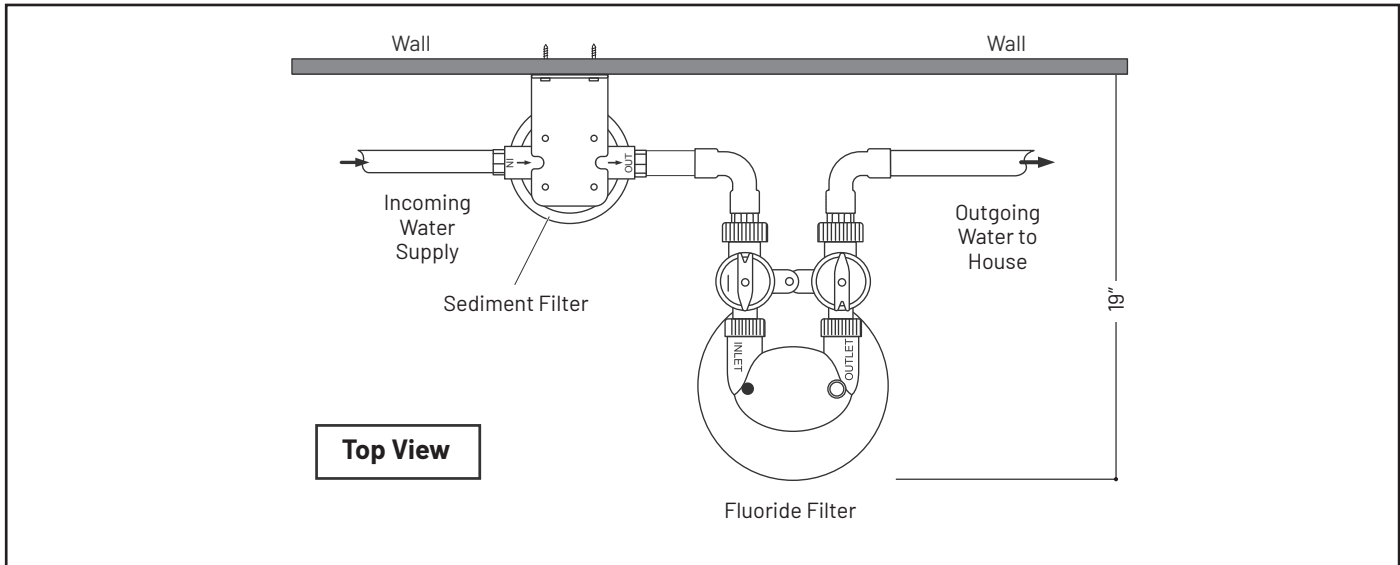

Note

Sediment filter position is at the discretion of your professional installer. As a general guideline, the sediment prefilter is typically installed in the "pre" position (as shown above) for well water applications. For city water applications, the sediment filter is typically installed in the "post" position after the fluoride filter tank.

PRE-INSTALLATION

Note

Head may come loose in transit. Please check head by tightening clock wise, hand tighten only, no more than $\frac{1}{4}$ turn.
Head may not move at all or less than $\frac{1}{4}$ turn.

Bypass Valve Installation

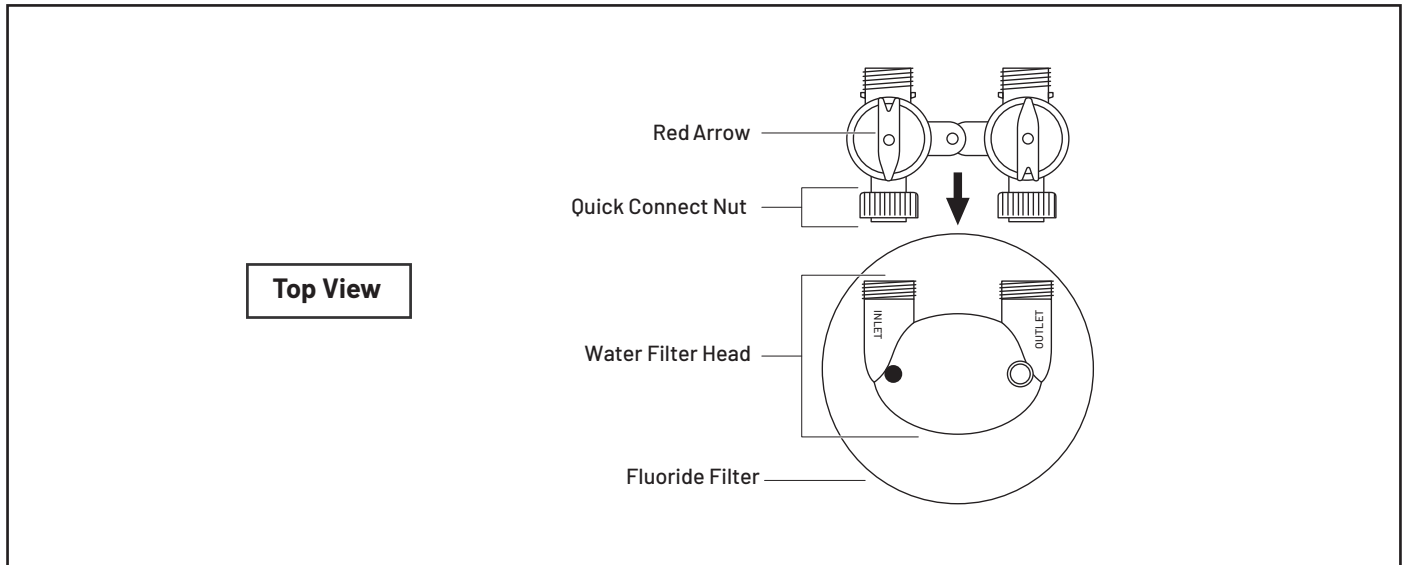

Figure 2

The bypass valve comes pre-assembled and ready to install with the o-rings, split rings, and quick connect nuts. Push the bypass valve into the head of the Fluoride Filter with the unthreaded ends oriented toward the tanks and hand-tighten the quick connect nuts.

Note

The bypass valve(s) included with this system are designed for multiple water systems. This may result in the arrows on the bypass valve(s) pointing differently than shown. If the arrows on your bypass valve(s) do not match the diagram, remove the red arrows by pulling them straight up, turn them 180° to match the drawing, and push them back down onto the stem.

FLUORIDE FILTER SOAK

IMPORTANT

Your system will not be ready for use for a minimum of 48 hours while the Fluoride Filter Soak process takes place. Please plan your installation accordingly.

Note

Water will flow out of the downflow inlet side of the Bypass Valve during this process. Be sure you perform this series of steps in a location suitable for water flow.

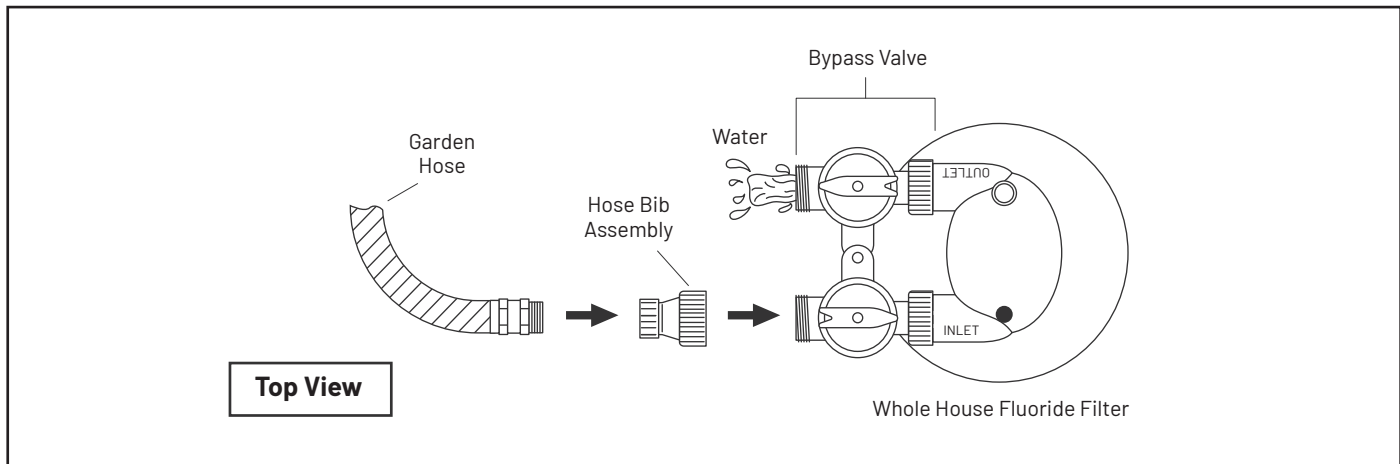

1. Attach a garden hose to the Hose Bib Assembly.
2. Connect the Hose Bib Assembly to the upflow inlet side of the Bypass Valve and hand tighten.
3. Fill the Pentair Whole House Fluoride Filter Tank full until water comes out of downflow inlet side of the Bypass Valve.
4. Turn the water off.
5. Remove the garden hose from the Hose Bib Assembly. Do not remove the fitting.
6. Allow the carbon tank to soak for at least 48 hours prior to tank installation.

FLUORIDE FILTER WASH



IMPORTANT

Do not perform the Fluoride Filter Wash until the Fluoride Filter Soak process is complete.



Note

Water will flow out of the downflow inlet side of the Bypass Valve during this process. Be sure you perform this series of steps in a location suitable for water flow.

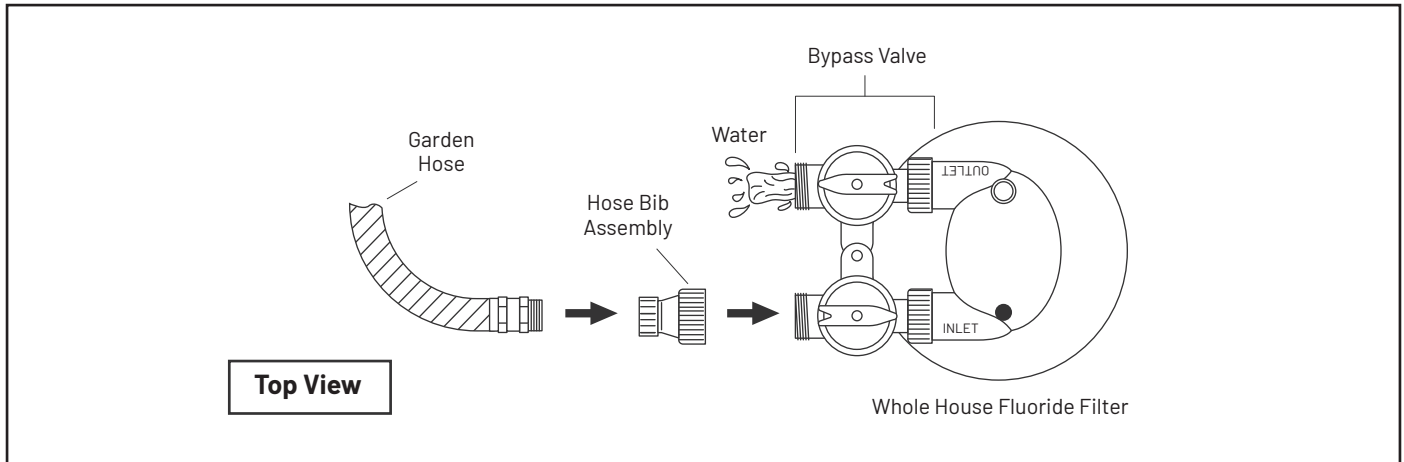

1. Reattach the garden hose to the Hose Bib Assembly.
2. Slowly turn on the water 1/4 turn for this entire process.
3. Run water through the upflow inlet side of the Bypass Valve for 15-30 minutes or until the water discharging from the downflow inlet side of the Bypass Valve runs clear.
4. Turn off the water.
5. Remove the Hose Bib Assembly from the upflow inlet side and attach it to the downflow inlet side of the Bypass Valve.
6. Run the water through the downflow inlet side for 1 minute or until water runs clear.
7. Turn off the water.
8. Remove the Hose Bib Assembly from the Bypass Valve and disconnect the garden hose.



Note

Please save the Hose Bib Assembly as this will be used in the future for the carbon exchange.

SEDIMENT FILTER INSTALLATION



Note

Sediment filter position is at the discretion of your professional installer. As a general guideline, the sediment pre filter is typically installed in the "pre" position (as shown above) for well-water applications. For city water applications, the sediment filter is typically installed in the "post" position after the fluoride filter tank.

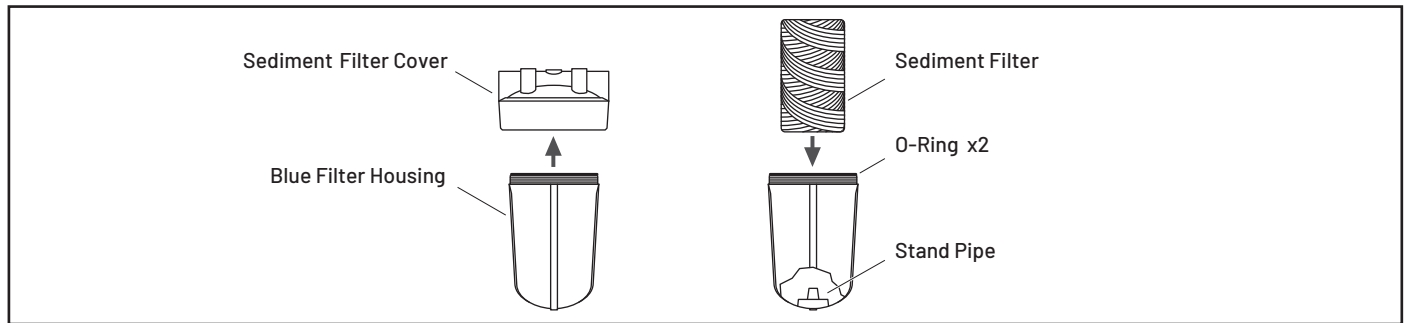

Part 1

1. Unscrew the cover from the blue filter housing.
2. Remove the plastic covering from the sediment filter.
3. Place the sediment filter onto the stand pipe in the blue filter housing and set aside.

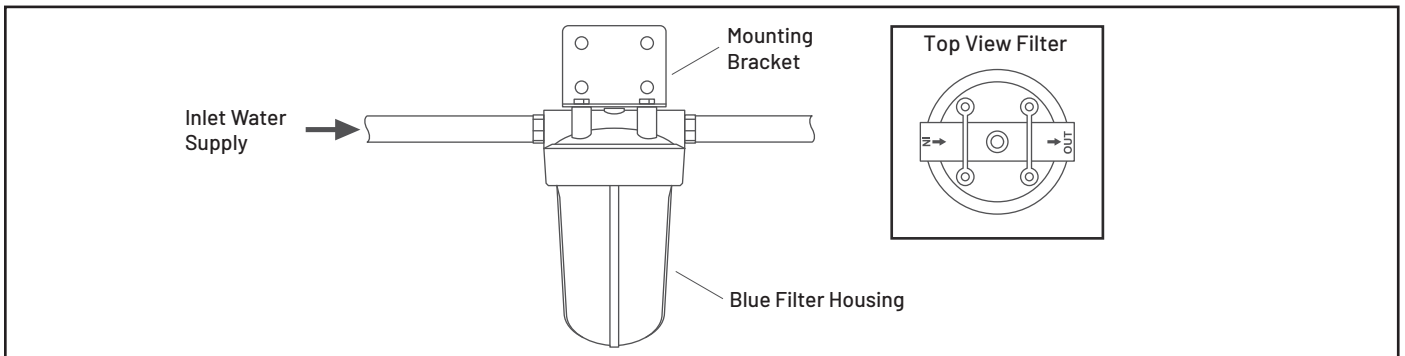

Part 2

1. Shut off the water.
2. Attach the filter cover to the mounting bracket using the supplied bolt head screws and washers. Make sure to properly orientate the IN and OUT to match your flow pattern.
3. Attach the mounting bracket to the wall using the supplied Phillips head screws.
4. Hand tighten the blue filter housing and then, using the supplied filter wrench, lightly snug the housing making sure not to over-tighten (counterclockwise).
5. Determine the size of your inlet water supply line.

FLUORIDE WATER FILTER SYSTEM TANK INSTALLATION

1. Level the fluoride filter tank.



Note

See "Troubleshooting" section on tips for leveling the tank.

If the tank is not level, lift the tank straight up 6 inches and tap it on the ground until the tank stands vertical. The bottom of the tank is round and the boot allows the tank to stand upright.

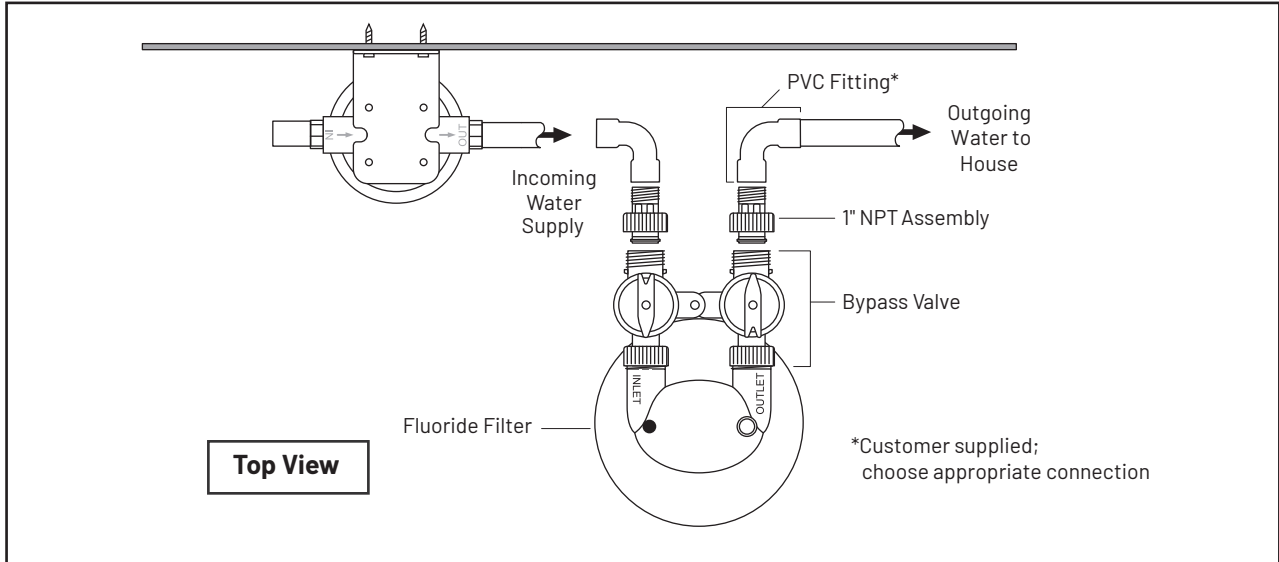

2. Determine the size and material of your incoming water supply line and choose the appropriate plumbing required to adapt to the 1" male NPT Assembly.



Note

Visit Pentair.com/homewater to view our full line of installation kits.



CAUTION

Do not over-tighten any of the fittings during installation.



Note

The fitting below is designed with a 1/4" give to allow for proper pipe alignment. It will not leak and is intended to have some flexibility.

Part	Description	Qty.
	1" Plastic Male NPT Assembly: V3007-04 WS1 Fitting 1" Plastic Male NPT Assembly (2); O-Rings (2), Split Rings (2), and Connectors (2)	1 bag

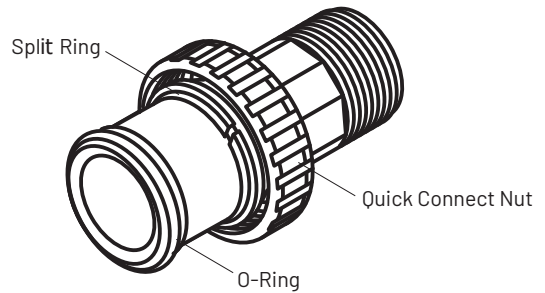

3. Install the fittings into the INLET and OUTLET sides of the bypass valve. Follow the diagram supplied with the fitting.
4. Connect the incoming water supply from the sediment filter to the fitting on the INLET side of the bypass valve.
5. Connect the outgoing water supply to the OUTLET side of the bypass valve.

BYPASS VALVE OPERATIONS

Figure A shows the system "in service" which allows water to flow in and out of the tank. In this position the system would be considered ON.

In Service

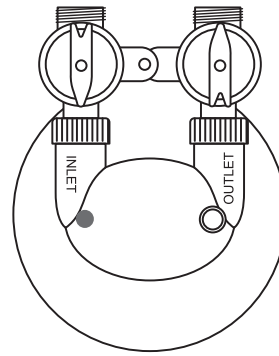

Figure A

Figure B shows the system "in bypass" which will direct water straight to the home without going in and out of the tank. In this position the system would be considered OFF.

In Bypass

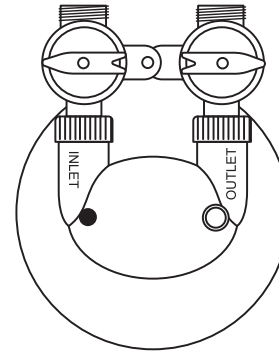
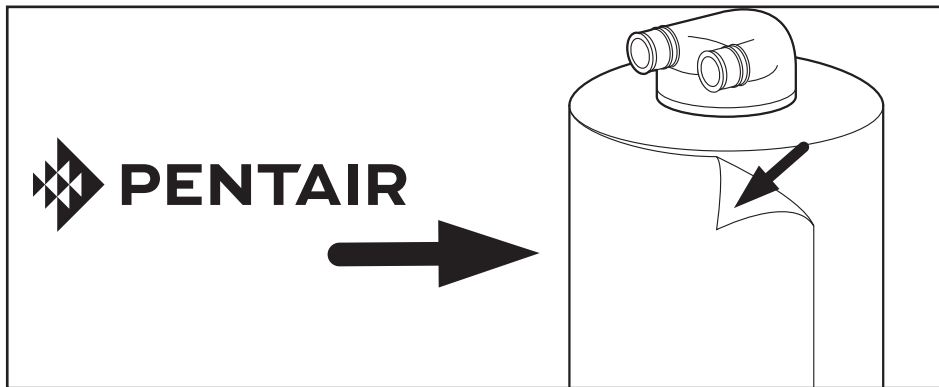

Figure B

COMPLETE THE INSTALLATION



1. Turn on main water supply and check for leaks.
2. Peel off the protective plastic wrap from the stainless steel tank jacket(s).
3. Add the Pentair logo sticker(s) in the desired location on the tank.
4. Wax stainless steel tank jacket(s) with wax provided (or any other non-abrasive auto wax) a minimum of 1-2 times per year or as needed based on the installed environment.

! CAUTION

Avoid high flow rates such as bathtub, utility sinks, hose bibs, multi-headed showers, body sprayers, or anything that is considered high flow for the first 72 hours to avoid flow restrictions caused by carbon blockage of the top basket inside the fluoride filter.

! CAUTION

Carbon dust may be released into the water lines of the house/building during the first few days of water use after fluoride filter installation. The carbon dust is harmless, but may give the water a gray appearance that should diminish within a week or 10 days depending on water use.

MAINTENANCE

Media Replacement

Your Pentair PF6-P Whole House Fluoride Filter requires care and cleaning after a period of 3 years. Replacement media and instructions can be ordered on-line at Pentair.com/homewater or by calling 877-842-1635.

Sediment Filter

It is recommended that the sediment filter be replaced every 6-9 months depending on the amount of sediment present in the water supply. If the system has been working properly and the pressure is slowing, it may be time to change the sediment filter. Check the sediment filter and replace if necessary.

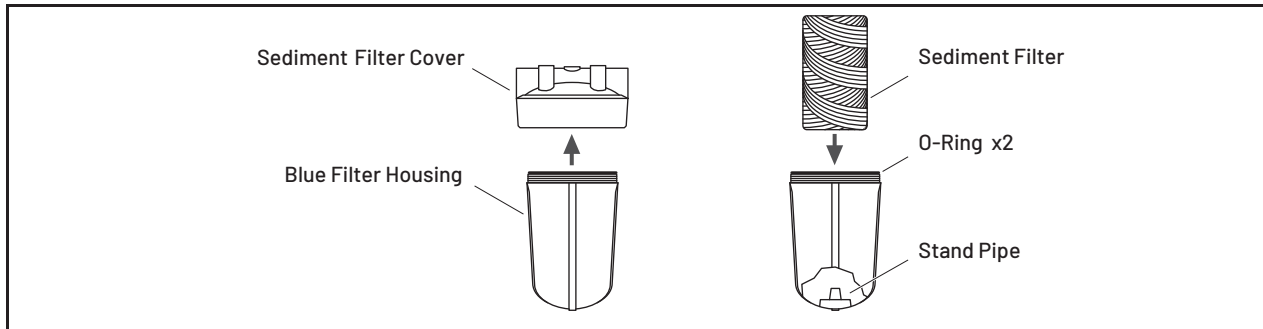

Replacing the Sediment Filter

1. Turn off the main water supply to the sediment filter system and bypass all tanks.
2. Run a faucet (cold water) inside the house to relieve the pressure. Leave the faucet open.
3. Unscrew the blue filter housing clockwise using the supplied filter wrench.
4. Remove the existing sediment filter and discard.
5. Remove the o-rings and wipe the upper groove clean. Lubricate two new o-rings with a coating of clean silicone grease. Replace both o-rings. Be sure to press the upper o-rings down into the groove with two fingers.



Note

This step is important to ensure the proper filter seal. Make sure the upper o-rings is seated level in the groove. If the o-ring appears damaged, stretched, or crimped it should be replaced.

6. Place a new sediment filter onto the stand pipe in the blue filter housing.
7. Screw the blue filter housing onto the filter cover hand tight. Lightly snug the housing with the spanner wrench making sure not to over-tighten.
8. Turn on the main water supply slowly to allow the sediment filter system to fill with water and expel air from lines. Put tanks back in service (out of bypass).
9. Check for leaks.

TROUBLESHOOTING

Problem	Solution
Water leaking at the top of the tank around the head.	You may need to turn the head to tighten it. The tank head is pre-installed hand-tight, do not overtighten the head (just turn it snug).
The tank leans to one side or is not level.	If the tank is not level, lift the tank straight up 6 inches and tap it on the ground until the tank stands vertical. The bottom of the tank is round and the boot allows the tank to stand upright.
Water pressure is slowing immediately after installation.	It is recommended that the sediment filter be replaced every 6-9 months depending on the amount of sediment present in the water supply. If the system has been working properly and the pressure is slowing, it may be time to change the sediment filter. Check the sediment filter and replace if necessary.
Water appears grey or cloudy.	Water may appear grey or cloudy for the first seven to ten days after installation due to extra carbon dust.

Note

If you have experienced a Boil Alert or require your system to be sanitized, please go to pentair.com/assets/pwsboilalert for product sanitization instructions.

PRODUCT WARRANTY AND REGISTRATION FORM

For details on your Pentair product warranty, please visit pentair.com/assets/residential-filtration-warranty.

Warranty Registration Form

Send in this Warranty Registration Form to validate your warranty or visit pentair.com/register-warranty to complete the warranty registration form online.

Date Item(s) were Received:	Order ID#:	Model:
_____	_____	_____
Dealer Purchased From:		

Model/Serial Number:		

Name:	_____	
Address:	_____	
City:	State:	Zip:
_____	_____	_____

Send to:

Pentair
2361 Mason Avenue, Suite 100
Daytona Beach, FL 32117
Phone: 1.800.842.1635



2361 Mason Ave | Suite 100 | Daytona Beach, FL 32117 | United States
P: 877.842.1635 | Technical Services: 877.842.1635 | pentair.com/homewater

© 2021 Pentair. All indicated Pentair trademarks and logos are property of Pentair. Third party registered and unregistered trademarks and logos are the property of their respective owners.

4006101 Rev B JLZ1