



AURORA[®]

MODELS 326A
IN LINE MOUNTED
CENTRIFUGAL PUMP REPAIR
INSTRUCTION MANUAL

NOTE! To the installer: Please make sure you provide this manual to the owner of the equipment or to the responsible party who maintains the system.

THIS PAGE INTENTIONALLY LEFT BLANK

CALIFORNIA PROPOSITION 65 WARNING:

 **Warning:** This product and related accessories contain chemicals known to the State of California to cause cancer, birth defects or other reproductive harm.

APPLICATIONS:

The 326A Series is a superior commercial in-line pump based on the Aurora Pump 320 series which has been manufactured and field tested under the severest demands of high temperature condensate service and boiler feed applications for over 45 years. Pumping applications for the 326A Series include: hot or chilled water circulation, pressure booster systems, and cooling towers for office buildings, hotels, hospitals, universities and warehouses.

Operational Limits.

Maximum Operating Pressure: 175 psi

Maximum Operating Temperature: 225°F (107°C)

ATTENTION: SAFETY WARNINGS:

Read and understand all warnings before installation or servicing pump.

ELECTRICAL SAFETY:

 **Warning:** Electrical Shock Hazard

All electrical connections are to be made by a qualified electrician in accordance with all codes and ordinances. Failure to follow these instructions could result in serious personal injury, death or property damage.

 **Warning:** Electrical Overload Hazard

Insure all motors have properly sized overload protection. Failure to follow these instructions could result in serious personal injury, death or property damage.

 **Warning:** Sudden Start-Up Hazard

Disconnect and lockout power source before servicing. Failure to follow these instructions could result in serious personal injury, death or property damage.

HIGH TEMPERATURE SAFETY:

 **Warning:** Hot Surface Hazard

If pumping hot water insure guards or proper insulation is installed to protect against skin contact to hot piping or pump components. Failure to follow these instructions could result in serious personal injury, death or property damage.

 **Warning:** Spraying Water Hazard

When servicing pump replace all gaskets and seals. Do not re-use old gaskets or seals. Failure to follow these instructions could result in serious personal injury, death or property damage.

HIGH PRESSURE SAFETY:

 **Warning:** High Pressure Hazard

The pump is rated at a maximum of 175 psi(175psi at 150°F). Do not exceed this pressure. Install properly sized pressure relief valves in system. Failure to follow these instructions could result in serious personal injury, death or property damage.

 **Warning:** Expansion Hazard

Water expands when heated. Install properly sized thermal expansion tanks and relief valves. Failure to follow these instructions could result in serious personal injury, death or property damage.

INSTALLATION:

The 326A pump can be installed either horizontally or vertically. Do not install with the motor below the pump. Install isolating valves on each side of pump so pump maintenance can be performed without draining the system. Special mounting requirements may be required if the pump is to be mounted near a noise or vibration sensitive area.

A minimum length of straight pipe is required on the suction side of the pump. Five times the pipe diameter is sufficient to allow a smooth entry of water into the pump.

Suction and discharge piping must be in line. Do not use pump casing to force the alignment of the piping. Properly support the piping to provide a rigid support for the pump. Tighten pump flanges evenly to prevent flange cocking and liquid leakage. The flange cap screw torque specification is 60 foot-pounds. Do not reuse old gaskets.

ELECTRICAL CONNECTIONS:

 **Warning:** Electrical Shock Hazard

All electrical connections are to be made by a qualified electrician in accordance with all codes and ordinances. Failure to follow these instructions could result in serious personal injury, death or property damage.

 **Warning:** Electrical Overload Hazard

Insure all motors have properly sized overload protection. Failure to follow these instructions could result in serious personal injury, death or property damage.

 **Warning:** Sudden Start-Up Hazard

Disconnect and lockout power source before servicing. Failure to follow these instructions could result in serious personal injury, death or property damage.

START UP:

The pump must be filled with water before start up or the mechanical seal will not be lubricated and will fail. Loosen vent plug on pump casing to insure all air is vented from casing and the casing is filled with water.

 **Warning:** Hot Surface Hazard

If pumping hot water, insure guards or proper insulation is installed to protect against skin contact to hot piping or pump components. Failure to follow these instructions could result in serious personal injury, death or property damage

 **Warning:** Spraying Water Hazard

When servicing pump replace all gaskets and seals. Do not re-use old gaskets or seals. Failure to follow these instructions could result in serious personal injury, death or property damage.

INSTALLATION:

Read and understand all safety warnings at the beginning of the manual before beginning installation or any repair work.

The Aurora Model 326A pump should be installed in an area where sufficient room is available for inspection and repair. We recommend that shut off valves be installed on both the suction and the discharge side of the pump to facilitate repair/replacement of the pump. The pump should not be located near any sound sensitive area and special precautions may be required to avoid sound and/or vibration transmission. Consult a vibration/sound specialist if applicable.

Insure that proper hydronic accessories such as pressure relief valves, thermal expansion tanks and flow/pressure control devices are installed in the system. Consult the responsible party for your system to insure these devices are installed and of the proper size.

The 326A pump can be installed in either vertical or horizontal mounting configurations. Under no circumstances should the pump be installed with the motor below the pump body. Insure that at least 5 diameters of straight pipe is present between the suction flange and the first pipe fitting. This allows a smooth and quite entrance of the pumped liquid into the pump.

Avoid all situations where pipe stain may be transferred to the pump casing. Expansion fittings and pipe hangers located close to the pump may be required. Do not force the piping to match the pump suction and discharge flanges. Re-cut the piping to avoid this situation. When tightening the suction and discharge flanges tighten each of the two mounting bolts equally to allow the flange faces to match squarely and the gaskets to seal correctly.

All electrical connections are to be completed by a qualified electrician. Insure properly sized overload protection is installed.

OPERATING:

Insure the system is filled with water and vented prior to pump start up. The pump rotation is clockwise when viewed from the back of the motor. Do not run the pump dry or the mechanical seal will be destroyed.

MAINTENANCE AND SERVICE TO THE PUMP:

The 326A pump requires no regular service. The ball bearings in the motor are permanently lubricated and require no re-greasing. A periodic inspection must be performed looking for seal leaks indicating the mechanical seal maybe worn out and any unusual noise or vibration that will indicate other pump components require service/repair.

**PUMP DISASSEMBLY:
READ AND UNDERSTAND ALL SAFETY WARNINGS AT THE BEGINNING OF THE MANUAL BEFORE BEGINNING INSTALLATION OR ANY REPAIR WORK.**

Refer to the exploded pump diagram for item numbers.

1. Insure the electrical power is locked out, the system pressure has been lowered to 0 psi and temperature of the unit is at a safe level.

 **Warning:** Sudden Start-Up Hazard

Disconnect and lockout power source before servicing. Failure to follow these instructions could result in serious personal injury, death or property damage.

 **Warning:** Hot Surface Hazard

If pumping hot water insure guards or proper insulation is installed to protect against skin contact to hot piping or pump components. Failure to follow these instructions could result in serious personal injury, death or property damage.

 **Warning:** High Pressure Hazard

The pump is rated at a maximum of 175 psi (175psi at 150°F). Do not exceed this pressure. Install properly sized pressure relief valves in system. Failure to follow these instructions could result in serious personal injury, death or property damage.

 **Warning:** Spraying Water Hazard

When servicing pump replace all gaskets and seals. Do not re-use old gaskets or seals. Failure to follow these instructions could result in serious personal injury, death or property damage.

2. Isolate the pump from the system by closing the valves that should be located on the suction and discharge side of the pump. Loosen one of the pipe plugs (#4) and drain the pump.
3. Remove the flange nuts and bolts (#21 & #20) and place the pump on a suitable work surface for pump disassembly.
4. Loosen the tube connector (#25).
5. Remove the four (4) casing bolts (#3) and separate the casing (#5) from the bracket (#16).
6. Remove the impeller bolt (#6) and washer (#7). The impeller (#8) can then be pulled straight off the motor shaft.
7. Remove the four (4) bolts (#14) holding the bracket (#16) to the motor and pull the bracket (along with the mechanical seal (#10) off the motor shaft.
8. The stationary seat of the mechanical seal (#10) can then be removed from the bracket (#16).
9. Always replace all gaskets (#19 & #11) and the mechanical seal (#10) when pump disassembly is required.

PUMP ASSEMBLY:

1. The pump can be re-assembled in the reverse order of its disassembly.
2. The mechanical seal stationary seat should be mounted in the bracket (#16) before the bracket is mounted to the motor. The rotating components of the mechanical seal should be lubricated with clean soapy solution to ease sliding the seal onto the motor shaft.
3. Always check for pump and system leaks prior to pump start up.

READ THE INSTALLATION AND OPERATING SECTION PRIOR TO PUMP START UP.

MODEL 326A

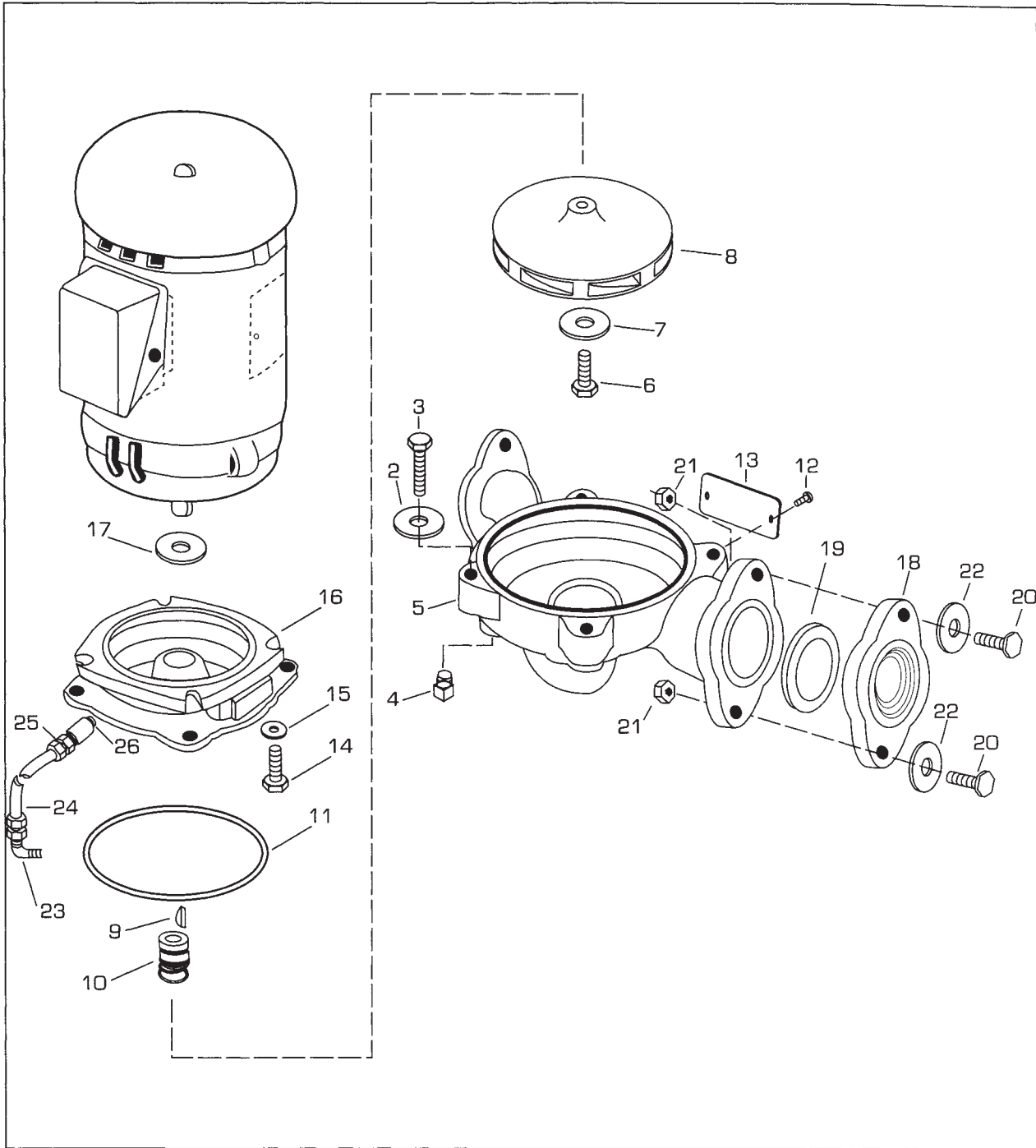

Figure 2. Model 326A Exploded View

THIS PAGE INTENTIONALLY LEFT BLANK

WARRANTY

Seller warrants equipment (and its component parts) of its own manufacture against defects in materials and workmanship under normal use and service for one (1) year from the date of installation or start-up, or for eighteen (18) months after the date of shipment, whichever occurs first. Seller does not warrant accessories or components that are not manufactured by Seller; however, to the extent possible, Seller agrees to assign to Buyer its rights under the original manufacturer's warranty, without recourse to Seller. Buyer must give Seller notice in writing of any alleged defect covered by this warranty (together with all identifying details, including the serial number, the type of equipment, and the date of purchase) within thirty (30) days of the discovery of such defect during the warranty period. No claim made more than 30 days after the expiration of the warranty period shall be valid. Guarantees of performance and warranties are based on the use of original equipment manufactured (OEM) replacement parts. Seller assumes no responsibility or liability if alterations, non-authorized design modifications and/or non-OEM replacement parts are incorporated. If requested by Seller, any equipment (or its component parts) must be promptly returned to Seller prior to any attempted repair, or sent to an authorized service station designated by Seller, and Buyer shall prepay all shipping expenses. Seller shall not be liable for any loss or damage to goods in transit, nor will any warranty claim be valid unless the returned goods are received intact and undamaged as a result of shipment. Repaired or replaced material returned to customer will be shipped F.O.B., Seller's factory. Seller will not give Buyer credit for parts or equipment returned to Seller, and will not accept delivery of any such parts or equipment, unless Buyer has obtained Seller's approval in writing. The warranty extends to repaired or replaced parts of Seller's manufacture for ninety (90) days or for the remainder of the original warranty period applicable to the equipment or parts being repaired or replaced, whichever is greater. This warranty applies to the repaired or replaced part and is not extended to the product or any other component of the product being repaired. Repair parts of its own manufacture sold after the original warranty period are warranted for a period of one (1) year from shipment against defects in materials and workmanship under normal use and service. This warranty applies to the replacement part only and is not extended to the product or any other component of the product being repaired. Seller may substitute new equipment or improve part(s) of any equipment judged defective without further liability. All repairs or services performed by Seller, which are not covered by this warranty, will be charged in accordance with Seller's standard prices then in effect.

THIS WARRANTY IS THE SOLE WARRANTY OF SELLER AND SELLER HEREBY EXPRESSLY DISCLAIMS AND BUYER WAIVES ALL OTHER WARRANTIES EXPRESSED, IMPLIED IN LAW OR IMPLIED IN FACT, INCLUDING ANY WARRANTIES OF MERCHANTABILITY OR FITNESS FOR A PARTICULAR PURPOSE. Seller's sole obligation under this warranty shall be, at its option, to repair or replace any equipment (or its component parts) which has a defect covered by this warranty, or to refund the purchase price of such equipment or part. Under the terms of this warranty, Seller shall not be liable for (a) consequential, collateral, special or liquidated losses or damages; (b) equipment conditions caused by normal wear and tear, abnormal conditions of use, accident, neglect, or misuse of said equipment; (c) the expense of, and loss or damage caused by, repairs or alterations made by anyone other than the Seller; (d) damage caused by abrasive materials, chemicals, scale deposits, corrosion, lightning, improper voltage, mishandling, or other similar conditions; (e) any loss, damage, or expense relating to or resulting from installation, removal or reinstallation of equipment; (f) any labor costs or charges incurred in repairing or replacing defective equipment or parts, including the cost of reinstalling parts that are repaired or replaced by Seller; (g) any expense of shipment of equipment or repaired or replacement parts; or (h) any other loss, damage or expense of any nature.

The above warranty shall not apply to any equipment which may be separately covered by any alternate or special warranties.

PERFORMANCE: In the absence of Certified Pump Performance Tests, equipment performance is not warranted or guaranteed. Performance curves and other information submitted to Buyer are approximate and no warranty or guarantee shall be deemed to arise as a result of such submittal. All testing shall be done in accordance with Seller's standard policy under Hydraulic Institute procedures.

LIABILITY LIMITATIONS: Under no circumstances shall the Seller have any liability under the Order or otherwise for liquidated damages or for collateral, consequential or special damages or for loss of profits, or for actual losses or for loss of production or progress of construction, regardless of the cause of such damages or losses. In any event, Seller's aggregate total liability under the Order or otherwise shall not exceed the contract price.

ACTS OF GOD: Seller shall in no event be liable for delays in delivery of the equipment or other failures to perform caused by fires, acts of God, strikes, labor difficulties, acts of governmental or military authorities, delays in transportation or procuring materials, or causes of any kind beyond Seller's control.

COMPLIANCE WITH LAW: Seller agrees to comply with all United States laws and regulations applicable to the manufacturing of the subject equipment. Such compliance shall include: The Fair Labor Standards Acts of 1938, as amended; Equal Employment Opportunity clauses of Executive Order 11246, as amended; Occupational Safety and Health Act of 1970 and the standards promulgated thereunder, if applicable. Since compliance with the various Federal, State, and Local laws and regulations concerning occupational health and safety, pollution or local codes are affected by the use, installation and operation of the equipment and other matters over which Seller has no control, Seller assumes no responsibility for compliance with those laws and regulations, whether by way of indemnity, warranty, or otherwise. It is incumbent upon the Buyer to specify equipment which complies with local codes and ordinances.



AURORA®

800 Airport Road
North Aurora, Illinois 60542
630-859-7000
www.aurorapump.com