

BERKELEY®

VERTICAL LINESHAFT TURBINES

No. Stages	Eff.
1	-2
2	-1
3	0
4	0

12VT2500 CLOSED IMPELLER 1770 R.P.M.

SINGLE STAGE LAB PERFORMANCE WITH STANDARD MATERIALS. EFFICIENCY SHOWN FOR 4 OR MORE STAGES. HORSE POWER SHOWN FOR ONE STAGE BASED ON 4 STAGE EFFICIENCY. CORRECTIONS SHOULD BE MADE FOR STAGES AND MATERIAL

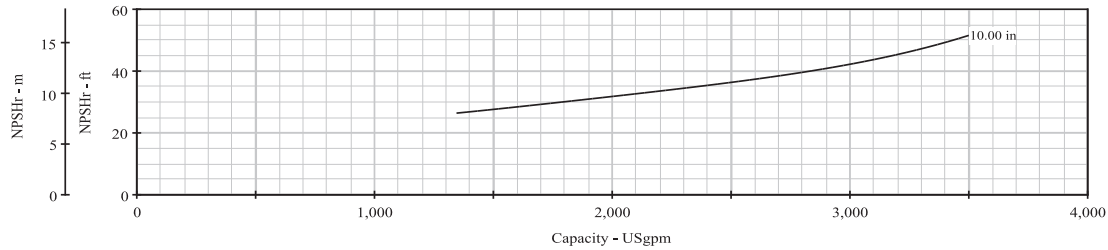
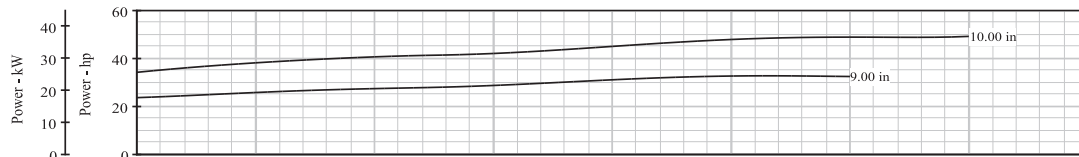
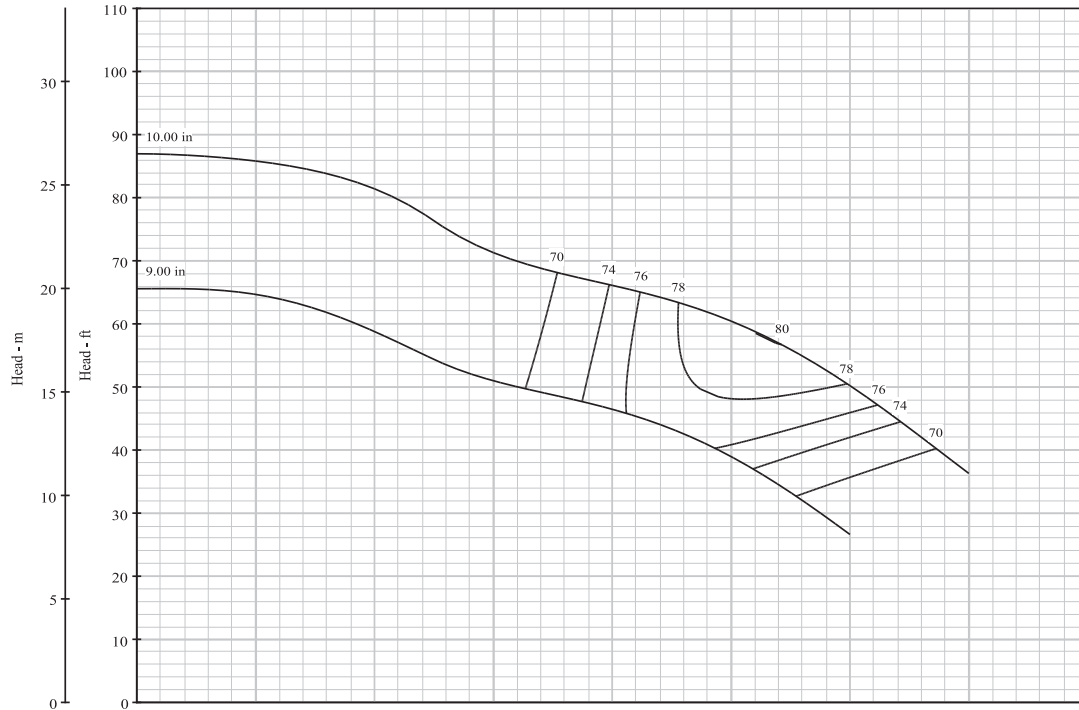

Maximum Operation Speed - RPM	1800	Maximum Sphere Size - inch	1.01
Pump Shaft Diameter - inch	1.687	Thrust Factor - Kt	10.97
Bowl Weight, 1st Stg W/L - lbs	193	WR2	1.07
Bowl Weight, 1st Stg O/L - lbs	241	Running Position (Above Seat) - inch	0.200
Bowl Weight, Ea. Add Stage - lbs	102	Submergence - inch	72
Allowable Shaft Stretch - inch	1.58	Max Bowl Brg Clearance - in. dia	0.014
Std Max Working Pressure - PSI	400	Max Wear Ring Clearance - in. dia	0.015
Optional Max Working Pressure - PSI	700	Max Bowl O.D. - inch	11.75
Impeller Eye Area - Sq. In	36.7	Suction Bell O.D. - inch	13
Rotor Weight 1st/add stages - lbs	29	Standard Max Number Stages	10
Additional Length Per Stage - inch	13.25	Optional Max Number Stages	10
Discharge Thread Column - inch	8 or 10	Suction Threads NPT - inch	8 or 10

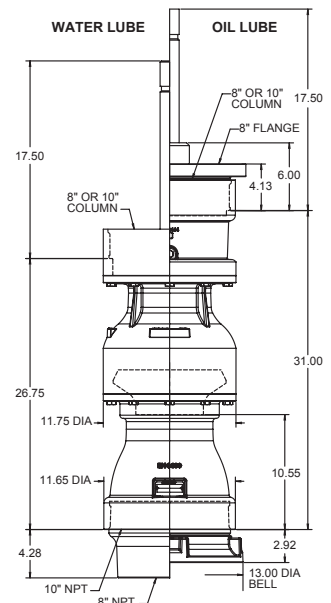

BERKELEY®

VERTICAL LINESHAFT TURBINES

No. Stages	Eff.
1	-2
2	-1
3	0
4	0

12VT2500K SEMI-OPEN IMPELLER 1770 R.P.M.

SINGLE STAGE LAB PERFORMANCE WITH STANDARD MATERIALS. EFFICIENCY SHOWN FOR 4 OR MORE STAGES. HORSE POWER SHOWN FOR ONE STAGE BASED ON 4 STAGE EFFICIENCY. CORRECTIONS SHOULD BE MADE FOR STAGES AND MATERIAL

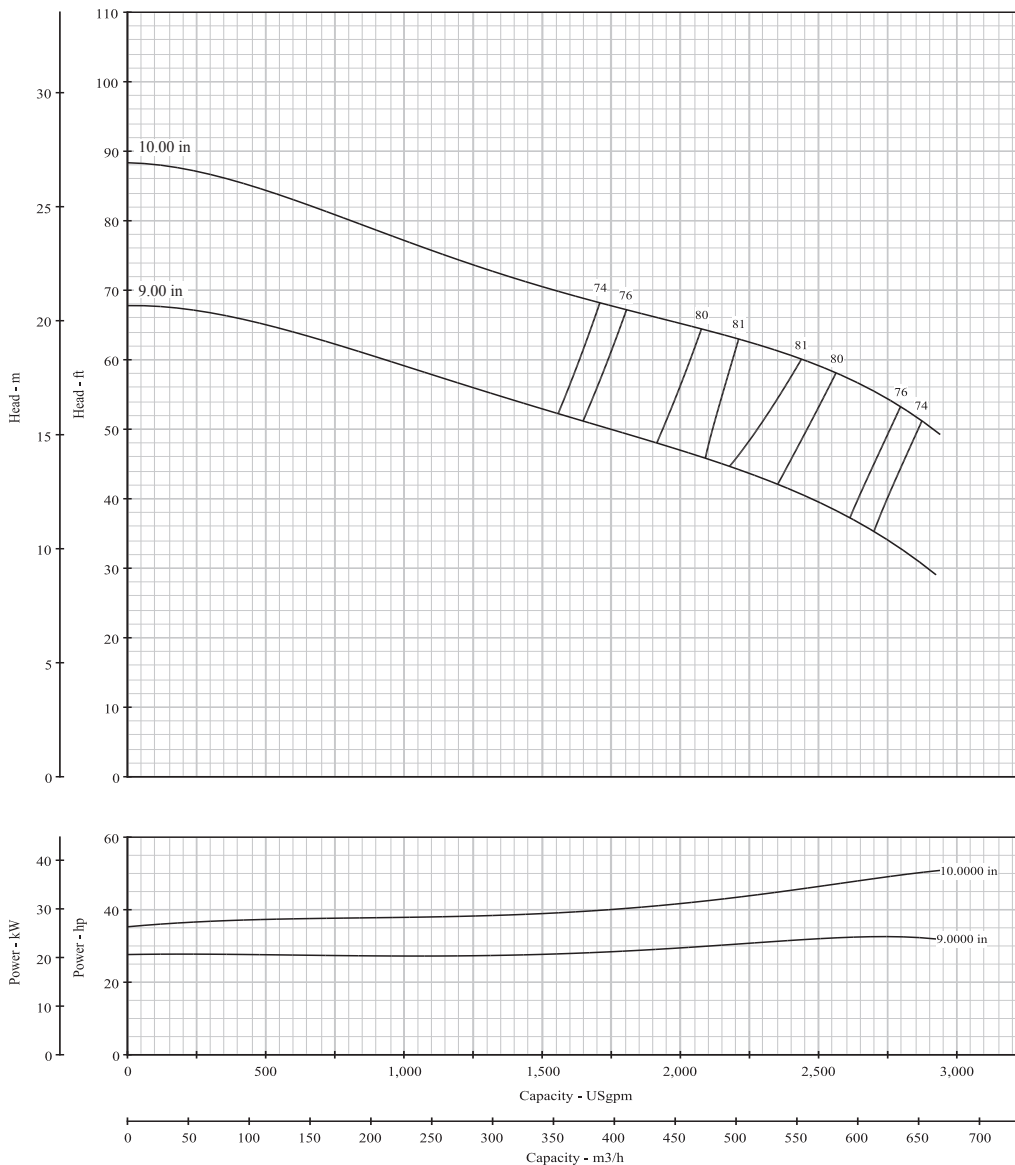

Maximum Operation Speed - RPM	1800	Maximum Sphere Size - inch	1.01
Pump Shaft Diameter - inch	1.687	Thrust Factor - Kt	13.16
Bowl Weight, 1st Stg W/L - lbs	193	WR ²	0.41
Bowl Weight, 1st Stg O/L - lbs	241	Running Position (Above Seat) - inch	0.015
Bowl Weight, Ea. Add Stage - lbs	102	Submergence - inch	65
Allowable Shaft Stretch - inch	1.58	Max Bowl Brg Clearance - in. dia	0.014
Std Max Working Pressure - PSI	400	Max Wear Ring Clearance - in. dia	N/A
Optional Max Working Pressure - PSI	0	Max Bowl O.D. - inch	11.75
Impeller Eye Area - Sq. In	36.7	Suction Bell O.D. - inch	13
Rotor Weight 1st/add stages - lbs	23.1	Standard Max Number Stages	10
Additional Length Per Stage - inch	13.25	Optional Max Number Stages	0
Discharge Thread Column - inch	8 or 10	Suction Threads NPT - inch	8 or 10

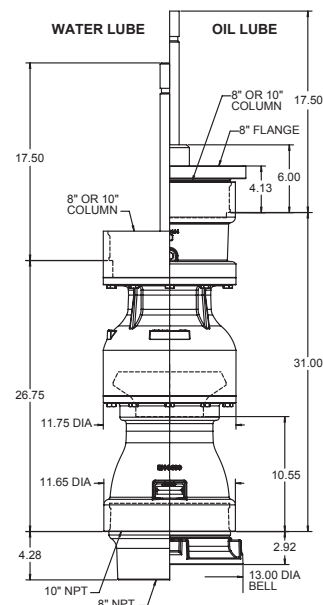

293 WRIGHT STREET, DELAVAN, WI 53115 WWW.BERKELEYPUMPS.COM
PH: 888-237-5353 ORDERS FAX: 800-321-8793

Because we are continuously improving our products and services, Pentair reserves the right to change specifications without prior notice.

B11736BK (08/10/16) © 2016 Pentair plc. All Rights Reserved.