

# Model ProFloSXT Upflow

---

## *Service Manual*

---



**IMPORTANT: Fill in Pertinent Information on Page 3 for Future Reference**

---

# Table of Contents

---



**IMPORTANT PLEASE READ:**

- The information, specifications and illustrations in this manual are based on the latest information available at the time of printing. The manufacturer reserves the right to make changes at any time without notice.
- This manual is intended as a guide for service of the valve only. System installation requires information from a number of suppliers not known at the time of manufacture. This product should be installed by a plumbing professional.
- This unit is designed to be installed on potable water systems only.
- This product must be installed in compliance with all state and municipal plumbing and electrical codes. Permits may be required at the time of installation.
- If daytime operating pressure exceeds 80 psi, nighttime pressures may exceed pressure limits. A pressure reducing valve must be installed.
- Do not install the unit where temperatures may drop below 32°F (0°C) or above 110°F (43°C).
- Do not place the unit in direct sunlight. Black units will absorb radiant heat increasing internal temperatures.
- Do not strike the valve or any of the components.
- Warranty of this product extends to manufacturing defects. Misapplication of this product may result in failure to properly condition water, or damage to product.
- A prefilter should be used on installations in which free solids are present.
- In some applications local municipalities treat water with Chloramines. High Chloramine levels may damage valve components.
- Correct and constant voltage must be supplied to the control valve to maintain proper function.

---

# Job Specification Sheet

---

Job Number: \_\_\_\_\_

Model Number: \_\_\_\_\_

Water Hardness: \_\_\_\_\_ ppm or gpg

Capacity Per Unit: \_\_\_\_\_

Mineral Tank Size: \_\_\_\_\_ Diameter: \_\_\_\_\_ Height: \_\_\_\_\_

Salt Setting per Regeneration: \_\_\_\_\_

**1. Type of Timer:**

- A. 7 Day or 12 Day      B. Meter Initiated

**2. Downflow      Upflow      Upflow Variable**

**3. Meter Size:**

- A. 3/4" Std Range (125 - 2,100 gallon setting)  
B. 3/4" Ext Range (625 - 10,625 gallon setting)  
C. 1" Std Range (310 - 5,270 gallon setting)  
D. 1" Ext Range (1,150 - 26,350 gallon setting)  
E. 1 1/2" Std Range (625 - 10,625 gallon setting)  
F. 1 1/2" Ext Range (3,125 - 53,125 gallon setting)  
G. 2" Std Range (1,250 - 21,250 gallon setting)  
H. 2" Ext Range (6,250 - 106,250 gallon setting)  
I. 3" Std Range (3,750 - 63,750 gallon setting)  
J. 3" Ext Range (18,750 - 318,750 gallon setting)  
K. Electronic \_\_\_\_\_ Pulse Count \_\_\_\_\_ Meter Size

**4. System Type:**

- A. System #4: 1 Tank, 1 Meter, Immediate, or Delayed Regeneration  
B. System #4: Time Clock  
C. System #4: Twin Tank  
D. System #5: 2-5 Tanks, 2 Meters, Interlock  
E. System #6: 2-5 Tanks, 1 Meter, Series Regeneration  
F. System #7: 2-5 Tanks, 1 Meter, Alternating  
G. System #9: Electronic Only, 2-4 Tanks, Meter per Valve, Alternating  
H. System #14: Electronic Only, 2-4 Tanks, Meter per Valve. Brings units on and offline based on flow.

**5. Timer Program Settings:**

- A. Backwash: \_\_\_\_\_ Minutes  
B. Brine and Slow Rinse: \_\_\_\_\_ Minutes  
C. Rapid Rinse: \_\_\_\_\_ Minutes  
D. Brine Tank Refill: \_\_\_\_\_ Minutes  
E. Pause Time: \_\_\_\_\_ Minutes  
F. Second Backwash: \_\_\_\_\_ Minutes

**6. Drain Line Flow Control:** \_\_\_\_\_ gpm

**7. Brine Line Flow Controller:** \_\_\_\_\_ gpm

**8. Injector Size#:** \_\_\_\_\_

**9. Piston Type:**

- A. Hard Water Bypass  
B. No Hard Water Bypass

---

# Installation Instructions

---

**WATER PRESSURE:** A minimum of 20 pounds of water pressure is required for regeneration valve to operate effectively.

**ELECTRICAL FACILITIES:** An uninterrupted alternating current (A/C) supply is required. Note: Other voltages are available. Please make sure your voltage supply is compatible with your unit before installation.

**EXISTING PLUMBING:** Condition of existing plumbing should be free from lime and iron buildup. Piping that is built up heavily with lime and/or iron should be replaced. If piping is clogged with iron, a separate iron filter unit should be installed ahead of the water softener.

**LOCATION OF SOFTENER AND DRAIN:** The softener should be located close to a drain to prevent air breaks and back flow.

**BY-PASS VALVES:** Always provide for the installation of a by-pass valve if unit is not equipped with one.

**CAUTION:** Water pressure is not to exceed 125 psi, water temperature is not to exceed 110°F, and the unit cannot be subjected to freezing conditions.

## Installation Instructions

1. Place the softener tank where you want to install the unit making sure the unit is level and on a firm base.
2. During cold weather, the installer should warm the valve to room temperature before operating.
3. All plumbing should be done in accordance with local plumbing codes. The pipe size for residential drain line should be a minimum of 1/2". Backwash flow rates in excess of 7 gpm or length in excess of 20' require 3/4" drain line. Commercial drain lines should be the same size as the drain line flow control.
4. Refer to the dimensional drawing for cutting height of the distributor tube. If there is no dimensional drawing, cut the distributor tube flush with the top of the tank.
5. Lubricate the distributor o-ring seal and tank "o" ring seal. Place the main control valve on tank.  
Note: Only use silicone lubricant.
6. Solder joints near the drain must be done prior to connecting the Drain Line Flow Control fitting (DLFC). Leave at least 6" between the DLFC and solder joints when soldering pipes that are connected on the DLFC. Failure to do this could cause interior damage to the DLFC.
7. Teflon tape is the only sealant to be used on the drain fitting. The drain from twin tank units may be run through a common line.
8. Make sure that the floor is clean beneath the salt storage tank and that it is level.
9. Place approximately 1" of water above the grid plate. If a grid is not utilized, fill to the top of the air check in the salt tank. Do not add salt to the brine tank at this time.
10. On units with a by-pass, place in by-pass position. Turn on the main water supply. Open a cold soft water tap nearby and let run a few minutes or until the system is free from foreign material (usually solder) that may have resulted from the installation. Once clean, close the water tap.
11. Slowly place the by-pass in service position and let water flow into the mineral tank. When water flow stops, slowly open a cold water tap nearby and let run until the air is purged from the unit.
12. Plug unit into an electrical outlet. Note: All electrical connections must be connected according to local codes. (Be certain the outlet is uninterrupted).

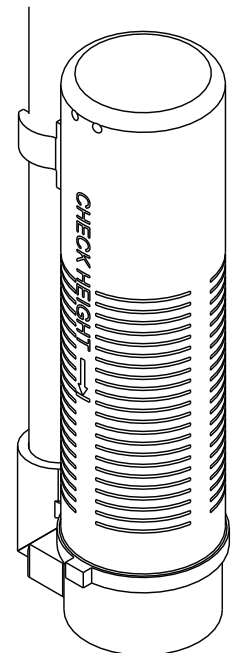

**NOTE: Residential Air Check Valve Pictured Above**

	<p><b>CAUTION</b></p> <ul style="list-style-type: none"><li>• Do not exceed 125 psi water pressure</li><li>• Do not exceed 110°F (43°C) water temperature</li><li>• Do not subject unit to freezing conditions</li></ul>
--	--

	<p><b>WARNING</b></p> <p>The system <b>MUST</b> be depressurized before removing any connections for servicing.</p>
--	---

---

## ***Start-Up Instructions***

---

The water softener should be installed with the inlet, outlet, and drain connections made in accordance with the manufacturer's recommendations, and to meet applicable plumbing codes.

1. Turn the manual regeneration knob slowly in a clockwise direction until the program micro switch lifts on top of the first set of pins. Allow the drive motor to move the piston to the first regeneration step and stop. Each time the program switch position changes, the valve will advance to the next regeneration step. Always allow the motor to stop before moving to the next set of pins or spaces.

**NOTE: For electronic valves, please refer to the manual regeneration part of the timer operation section. If the valve came with a separate electronic timer service manual, refer to the timer operation section of the electronic timer service manual.**

2. Position the valve to backwash. Ensure the drain line flow remains steady for 10 minutes or until the water runs clear (see above).
3. Position the valve to the brine / slow rinse position. Ensure the unit is drawing water from the brine tank (this step may need to be repeated).
4. Position the valve to the rapid rinse position. Check the drain line flow, and run for 5 minutes or until the water runs clear.
5. Position the valve to the start of the brine tank fill cycle. Ensure water goes into the brine tank at the desired rate. The brine valve drive cam will hold the valve in this position to fill the brine tank for the first regeneration.
6. Replace control box cover.
7. Put salt in the brine tank.

**NOTE: Do not use granulated or rock salt.**

---

## Timer Features

---

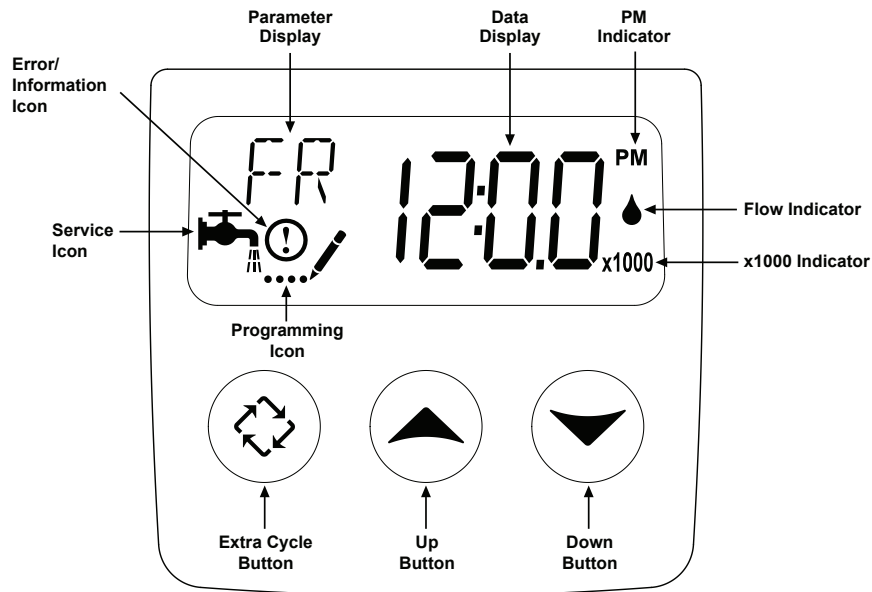

### Features of the SXT:

- Power backup that continues to keep time and the passage of days for a minimum of 48 hours in the event of power failure. During a power outage, the control goes into a power-saving mode. It does not monitor water usage during a power failure, but it does store the volume remaining at the time of power failure.
- Settings for both valve (basic system) and control type (method used to trigger a regeneration).
- Day-of-the-Week controls.
- While in service, the display alternates between time of day, volume remaining or days to regeneration, and tank in service (twin tank systems only).
- The Flow Indicator flashes when outlet flow is detected.
- The Service Icon flashes if a regeneration cycle has been queued.
- A Regeneration can be triggered immediately by pressing the Extra Cycle button for five seconds.
- The Parameter Display displays the current Cycle Step (BW, BF, RR, etc) during regeneration, and the data display counts down the time remaining for that cycle step. While the valve is transferring to a new cycle step, the display will flash. The parameter display will identify the destination cycle step (BW, BF, RR, etc) and the data display will read "----". Once the valve reaches the cycle step, the display will stop flashing and the data display will change to the time remaining. During regeneration, the user can force the control to advance to the next cycle step immediately by pressing the extra cycle button.

### Setting the Time of Day

1. Press and hold either the Up or Down buttons until the programming icon replaces the service icon and the parameter display reads TD.
2. Adjust the displayed time with the Up and Down buttons.
3. When the desired time is set, press the Extra Cycle button to resume normal operation. The unit will also return to normal operation after 5 seconds if no buttons are pressed.

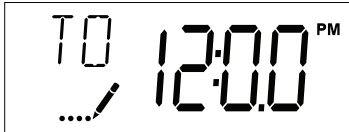

### Queueing a Regeneration

1. Press the Extra Cycle button. The service icon will flash to indicate that a regeneration is queued.
2. To cancel a queued regeneration, press the Extra Cycle button.

### Regenerating Immediately

Press and hold the Extra Cycle button for five seconds.

---

# Timer Operation

---

## Meter Immediate Control

A meter immediate control measures water usage and regenerates the system as soon as the calculated system capacity is depleted. The control calculates the system capacity by dividing the unit capacity (typically expressed in grains/unit volume) by the feedwater hardness and subtracting the reserve. Meter Immediate systems generally do not use a reserve volume. However, in twin tank systems with soft-water regeneration, the reserve capacity should be set to the volume of water used during regeneration to prevent hard water break-through. A Meter Immediate control will also start a regeneration cycle at the programmed regeneration time if a number of days equal to the regeneration day override pass before water usage depletes the calculated system capacity.

## Meter Delayed Control

A Meter Delayed Control measures water usage and regenerates the system at the programmed regeneration time after the calculated system capacity is depleted. As with Meter Immediate systems, the control calculates the system capacity by dividing the unit capacity by the feedwater hardness and subtracting the reserve. The reserve should be set to insure that the system delivers treated water between the time the system capacity is depleted and the actual regeneration time. A Meter Delayed control will also start a regeneration cycle at the programmed regeneration time if a number of days equal to the regeneration day override pass before water usage depletes the calculated system capacity.

## Time Clock Delayed Control

A Time Clock Delayed Control regenerates the system on a timed interval. The control will initiate a regeneration cycle at the programmed regeneration time when the number of days since the last regeneration equals the regeneration day override value.

## Day of the Week Control

This control regenerates the system on a weekly schedule. The schedule is defined in Master Programming by setting each day to either "off" or "on." The control will initiate a regeneration cycle on days that have been set to "on" at the specified regeneration time.

## Control Operation During Regeneration

During regeneration, the control displays a special regeneration display. In this display, the control shows the current regeneration step number the valve is advancing to, or has reached, and the time remaining in that step. The step number that displays flashes until the valve completes driving to this regeneration step position. Once all regeneration steps are complete the valve returns to service and resumes normal operation.

Pressing the Extra Cycle button during a regeneration cycle immediately advances the valve to the next cycle step position and resumes normal step timing.

## Control Operation During Programming

The control only enters the Program Mode with the valve in service. While in the Program Mode, the control continues to operate normally monitoring water usage and keeping all displays up to date. Control programming is stored in memory permanently, eliminating the need for battery backup power.

## Manually Initiating a Regeneration

1. When timer is in service, press the Extra Cycle button for 5 seconds on the main screen.
2. The timer advances to Regeneration Cycle Step #1 (backwash), and begins programmed time count down.
3. Press the Extra Cycle button once to advance valve to Regeneration Cycle Step #2 (brine draw & slow rinse).
4. Press the Extra Cycle button once to advance valve to Regeneration Cycle Step #3 (rapid rinse).
5. Press the Extra Cycle button once to advance valve to Regeneration Cycle Step #4 (brine refill).
6. Press the Extra Cycle button once more to advance the valve back to in service.

**NOTE:** If the unit is a filter or upflow, the cycle step order may change.

**NOTE:** A queued regeneration can be initiated by pressing the Extra Cycle button. To clear a queued regeneration, press the Extra Cycle button again to cancel. If regeneration occurs for any reason prior to the delayed regeneration time, the manual regeneration request shall be cleared.



### **Control Operation During A Power Failure**

The SXT includes integral power backup. In the event of power failure, the control shifts into a power-saving mode. The control stops monitoring water usage, and the display and motor shut down, but it continues to keep track of the time and day for a minimum of 48 hours.

The system configuration settings are stored in a non-volatile memory and are stored indefinitely with or without line power. The Time of Day flashes when there has been a power failure. Press any button to stop the Time of Day from flashing.

If power fails while the unit is in regeneration, the control will save the current valve position before it shuts down. When power is restored, the control will resume the regeneration cycle from the point where power failed. Note that if power fails during a regeneration cycle, the valve will remain in its current position until power is restored. The valve system should include all required safety components to prevent overflows resulting from a power failure during regeneration.

The control will not start a new regeneration cycle without line power. If the valve misses a scheduled regeneration due to a power failure, it will queue a regeneration. Once power is restored, the control will initiate a regeneration cycle the next time that the Time of Day equals the programmed regeneration time. Typically, this means that the valve will regenerate one day after it was originally scheduled. If the treated water output is important and power interruptions are expected, the system should be setup with a sufficient reserve capacity to compensate for regeneration delays.

# Master Programming Mode Chart

Master Programming Options			
Abbreviation	Parameter	Option Abbreviation	Options
DF	Display Format	GAL	Gallons
		Ltr	Liters
		Cu	Cubic Meters
VT	Valve Type	St1b	Standard Downflow/Upflow Single Backwash
		St2b	Standard Downflow/Upflow Double Backwash
		Filtr	Filter
		UFbF	Upflow Brine First
		Othr	Other
CT	Control Type	Fd	Meter (Flow) Delayed
		FI	Meter (Flow) Immediate
		tc	Time Clock
		dAY	Day of Week
NT	Number of Tanks	1	Single Tank System
		2	Two Tank System
TS	Tank in Service	U1	Tank 1 in Service
		U2	Tank 2 in Service
C	Unit Capacity		Unit Capacity (Grains)
H	Feedwater Hardness		Hardness of Inlet Water
RS	Reserve Selection	SF	Percentage Safety Factor
		rc	Fixed Reserve Capacity
SF	Safety Factor		Percentage of the system capacity to be used as a reserve
RC	Fixed Reserve Capacity		Fixed volume to be used as a reserve
DO	Day Override		The system's day override setting
RT	Regen Time		The time of day the system will regenerate
BW, BD, RR, BF	Regen Cycle Step Times		The time duration for each regeneration step. Adjustable from OFF and 0-199 minutes. <b>NOTE: If "Othr" is chosen under "Valve Type", then R1, R2, R3, etc, will be displayed instead</b>
D1, D2, D3, D4, D5, D6, & D7	Day of Week Settings		Regeneration setting (On or OFF) for each day of the week on day-of-week systems
CD	Current Day		The Current day of the week

**CAUTION: Before entering Master Programming, please contact your local professional water dealer.**

---

## **Master Programming Mode Chart**

---

<b>Master Programming Options</b>			
FM	Flow Meter Type	t0.7	3/4" Turbine Meter
		P0.7	3/4" Paddle Wheel Meter
		t1.0	1" Turbine Meter
		P1.0	1" Paddle Wheel Meter
		t1.5	1.5" Turbine Meter
		P1.5	1.5" Paddle Wheel Meter
		Gen	Generic or Other Meter
K	Meter Pulse Setting		Meter pulses per gallon for generic/other flow meter

**NOTES:**

Some items may not be shown depending on timer configuration.

The timer will discard any changes and exit Master Programming Mode if any button is not pressed for sixty seconds.

**CAUTION:** Before entering Master Programming, please contact your local professional water dealer.

---

# Master Programming Mode

---

When the Master Programming Mode is entered, all available option setting displays may be viewed and set as needed. Depending on current option settings, some parameters cannot be viewed or set.

## Entering Master Programming Mode

Set the Time Of Day display to **12:01 P.M.** Then press and hold the Up and Down buttons together until the programming icon replaces the service icon and the Display Format screen appears.

## Exiting Master Programming Mode

Press the Extra Cycle button to accept the displayed settings and cycle to the next parameter. Press the Extra Cycle button at the last parameter to save all settings and return to normal operation. The control will automatically disregard any programming changes and return to normal operation if it is left in Master Programming mode for 5 minutes without any keypad input.

## Resets:

**Soft Reset:** Press and hold the Extra Cycle and Down buttons for 25 seconds while in normal Service mode. This resets all parameters to the system default values, except the volume remaining in meter immediate or meter delayed systems and days since regeneration in the time clock system.

**Master Reset:** Hold the Extra Cycle button while powering up the unit. This resets all of the parameters in the unit. Check and verify the choices selected in Master Programming Mode.

## 1. Display Format (Display Code DF)

This is the first screen that appears when entering Master Programming Mode. The Display Format setting specifies the unit of measure that will be used for volume and how the control will display the Time of Day. This option setting is identified by "DF" in the upper left hand corner of the screen. There are three possible settings:

Display Format Setting	Unit of Volume	Time Display
GAL	U.S. Gallons	12-Hour AM/PM
Ltr	Liters	24-Hour
Cu	Cubic Meters	24-Hour

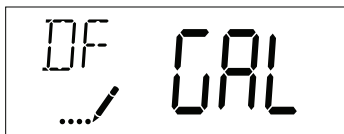

**CAUTION:** Before entering Master Programming, please contact your local professional water dealer.

---

# Master Programming Mode

---

## 2. Valve Type (Display Code VT)

Press the Extra Cycle button. Use this display to set the Valve Type. The Valve Type setting specifies the type of cycle that the valve follows during regeneration. Note that some valve types require that the valve be built with specific subcomponents. Ensure the valve is configured properly before changing the Valve Type setting. This option setting is identified by “VT” in the upper left hand corner of the screen. There are 5 possible settings:

Abbreviation	Parameter
St1b	Standard Downflow/Upflow, Single Backwash
St2b	Standard Downflow/Upflow, Double Backwash
Fltr	Filter
UFbF	Upflow Brine First
Othr	Other



## 3. Control Type (Display Code CT)

Press the Extra Cycle button. Use this display to set the Control Type. This specifies how the control determines when to trigger a regeneration. For details on how the various options function, refer to the “Timer Operation” section of this service manual. This option setting is identified by “CT” in the upper left hand corner of the screen. There are four possible settings:

Meter Delayed: Fd  
Meter Immediate: FI  
Time Clock: tc  
Day of Week: dAY

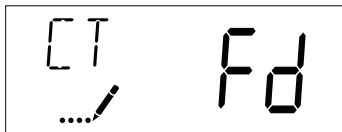

## 4. Number of Tanks (Display Code NT)

Press the Extra Cycle button. Use this display to set the Number of Tanks in your system. This option setting is identified by “NT” in the upper left hand corner of the screen. There are two possible settings:

Single Tank System: 1  
Two-Tank System: 2

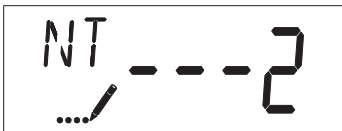

**CAUTION: Before entering Master Programming, please contact your local professional water dealer.**

---

# Master Programming Mode

---

## 5. Tank in Service (Display Code TS)

Press the Extra Cycle button. Use this display to set whether tank one or tank two is in service. This option setting is identified by "TS" in the upper left hand corner of the screen. This parameter is only available if the number of tanks has been set to 2. There are two possible settings:

Tank One in Service: U1

Tank Two in Service: U2

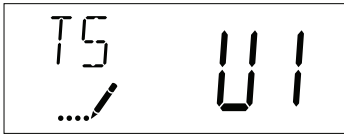

## 6. Unit Capacity (Display Code C)

Press the Extra Cycle button. Use this display to set the Unit Capacity. This setting specifies the treatment capacity of the system media. Enter the capacity of the media bed in grains of hardness when configuring a softener system, and in the desired volume capacity when configuring a filter system. This option setting is identified by "C" in the upper left hand corner of the screen. The Unit Capacity parameter is only available if the control type has been set to one of the metered options. Use the Up and Down buttons to adjust the value as needed.

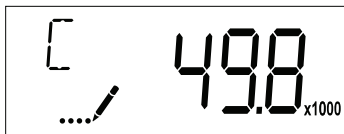

Range: 1-999,9900 grain capacity

## 7. Feedwater Hardness (Display Code H)

Press the Extra Cycle button. Use this display to set the Feedwater Hardness. Enter the feedwater hardness in grains per unit volume for softener systems, or 1 for filter systems. This option setting is identified by "H" in the upper left hand corner of the screen. The feedwater hardness parameter is only available if the control type has been set to one of the metered options. Use the Up and Down buttons to adjust the value as needed.

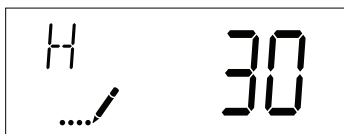

Range: 4-199 hardness

**CAUTION: Before entering Master Programming, please contact your local professional water dealer.**

---

# Master Programming Mode

---

## 8. Reserve Selection (Display Code RS)

Press the Extra Cycle button. Use this display to set the Safety Factor. Use this display to select the type of reserve to be used in your system. This setting is identified by "RS" in the upper left-hand corner of the screen. The reserve selection parameter is only available if the control type has been set to one of the metered options. There are two possible settings.

FS	Safety Fector
rc	Fixed Reserve Capacity

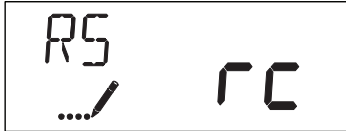

## 9. Safety Factor (Display Code SF)

Press the Extra Cycle button. Use this display to set the Safety Factor. This setting specifies what percentage of the system capacity will be held as a reserve. Since this value is expressed as a percentage, any change to the unit capacity or feedwater hardness that changes the calculated system capacity will result in a corresponding change to the reserve volume. This option setting is identified by "SF" in the upper left hand corner of the screen. Use the Up and Down buttons to adjust the value from 0 to 50% as needed.

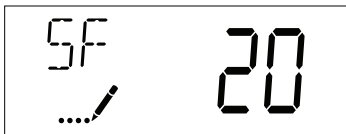

Range: 0-50%

## 10. Fixed Reserve Capacity (Display Code RC)

Press the Extra Cycle button. Use this display to set the Reserve Capacity. This setting specifies a fixed volume that will be held as a reserve. The reserve capacity cannot be set to a value greater than one-half of the calculated system capacity. The reserve capacity is a fixed volume and does not change if the unit capacity or feedwater hardness are changed. This option setting is identified by "RC" in the upper left-hand corner of the screen. Use the Up and Down buttons to adjust the value as needed.



Range: 0-half the calculated capacity

---

**CAUTION: Before entering Master Programming, please contact your local professional water dealer.**

---

---

# Master Programming Mode

---

## 11. Day Override (Display Code DO)

Press the Extra Cycle button. Use this display to set the Day Override. This setting specifies the maximum number of days between regeneration cycles. If the system is set to a timer-type control, the day override setting determines how often the system will regenerate. A metered system will regenerate regardless of usage if the days since last regeneration cycle equal the day override setting. Setting the day override value to "OFF" disables this function. This option setting is identified by "DO" in the upper left hand corner of the screen. Use the Up and Down buttons to adjust the value as needed.



Range: Off-99 days

## 12. Regeneration Time

Press the Extra Cycle button. Use this display to set the Regeneration Time. This setting specifies the time of day the control will initiate a delayed, manually queued, or day override triggered regeneration. This option setting is identified by "RT" in the upper left hand corner of the screen. Use the Up and Down buttons to adjust the value as needed.

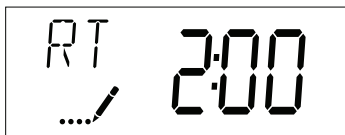

## 13. Regeneration Cycle Step Times

Press the Extra Cycle button. Use this display to set the Regeneration Cycle Step Times. The different regeneration cycles are listed in sequence based on the valve type selected for the system, and are identified by an abbreviation in the upper left-hand corner of the screen. The abbreviations used are listed below. If the system has been configured with the "OTHER" valve type, the regeneration cycles will be identified as R1, R2, R3, R4, R5, and R6. Each cycle step time can be set from 0 to 199 minutes, or "OFF." Setting a cycle step to "OFF" will disable all of the following steps. Setting a cycle step time to 0 will cause the control to skip that step during regeneration, but keeps the following steps available. Use the Up and Down buttons to adjust the value as needed. Press the Extra Cycle button to accept the current setting and move to the next parameter.

Cycle Step	Abbreviation
BD	Brine Draw
BF	Brine Fill
BW	Backwash
RR	Rapid Rinse
SV	Service

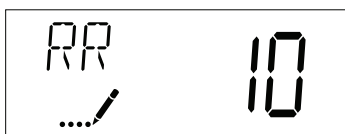

Range: 0-199 minutes

**CAUTION: Before entering Master Programming, please contact your local professional water dealer.**



---

# Master Programming Mode

---

## 14. Day of Week Settings

Press the Extra Cycle button. Use this display to set the regeneration schedule for a system configured as a Day of Week control. The different days of the week are identified as D1, D2, D3, D4, D5, D6, and D7 in the upper left-hand corner of the display. Set the value to "ON" to schedule a regeneration or "OFF" to skip regeneration for each day. Use the Up and Down buttons to adjust the setting as needed. Press the Extra Cycle button to accept the setting and move to the next day. Note that the control requires at least one day to be set to "ON." If all 7 days are set to "OFF", the unit will return to Day One until one or more days are set to "ON."

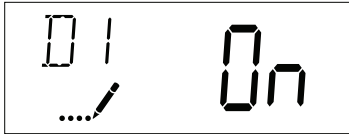

## 15. Current Day (Display Code CD)

Press the Extra Cycle button. Use this display to set the current day on systems that have been configured as Day of Week controls. This setting is identified by "CD" in the upper left-hand corner of the screen. Use the Up and Down buttons to select from Day 1 through Day 7.



## 16. Flow Meter Type (Display Code FM)

Press the Extra Cycle button. Use this display to set the type of flow meter connected to the control. This option setting is identified by "FM" in the upper left-hand corner of the screen. Use the Up and Down buttons to select one of the 7 available settings.

t0.7	Fleck 3/4" Turbine Meter
P0.7	Fleck 3/4" Paddle Wheel Meter
t1.0	Fleck 1" Turbine Meter
P1.0	Fleck 1" Paddle Wheel Meter
t1.5	Fleck 1 1/2" Turbine Meter
P1.5	Fleck 1 1/2" Paddle Wheel Meter
GEn	Generic/Other Meter

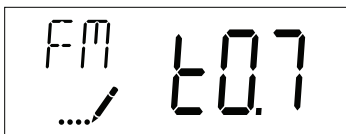

**CAUTION:** Before entering Master Programming, please contact your local professional water dealer.

---

## Master Programming Mode

---

### 17. Meter Pulse Setting (Display Code K)

Press the Extra Cycle button. Use this display to specify the meter pulse setting for a non-standard flow meter. This option setting is identified by "K" in the upper left-hand corner of the screen. Use the Up and Down buttons to enter the meter constant in pulses per unit volume.

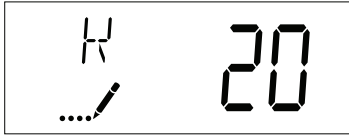

18. Press the Extra Cycle button to save all settings and exit Master Programming Mode.

---

# User Programming Mode

---

User Programming Mode Options		
Abbreviation	Parameter	Description
DO	Day Override	The timer's day override setting
RT	Regeneration Time	The time of day that the system will regenerate (meter delayed, timeclock, and day-of-week systems)
H	Feed Water Hardness	The hardness of the inlet water - used to calculate system capacity for metered systems
RC	Reserve Capacity	The fixed reserve capacity
CD	Current Day	The current day of week

## NOTES:

Some items may not be shown depending on timer configuration.

The timer will discard any changes and exit User Mode if any button is not pressed for sixty seconds.

## User Programming Mode Steps

1. Press the Up and Down buttons for five seconds while in service, and the time of day is NOT set to 12:01 PM.
2. Use this display to adjust the Day Override. This option setting is identified by "DO" in the upper left hand corner of the screen.



3. Press the Extra Cycle button. Use this display to adjust the Regeneration Time. This option setting is identified by "RT" in the upper left hand corner of the screen.

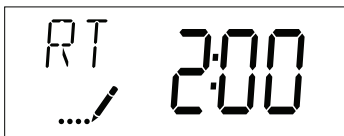

4. Press the Extra Cycle button. Use this display to adjust the Feed Water Hardness. This option setting is identified by "FH" in the upper left hand corner of the screen.

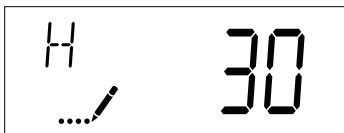

Range: 4-199 hardness

---

## User Programming Mode

---

1. Press the Extra Cycle button. Use this display to adjust the Fixed Reserve Capacity. This option setting is identified by "RC" in the upper left-hand corner of the screen.

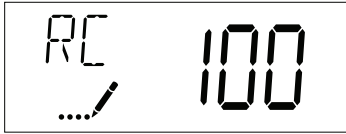

2. Press the Extra Cycle button. Use this display to set the Current Day of the Week. This option setting is identified by "CD" in the upper left hand corner of the screen.



3. Press the Extra Cycle button to end User Programming Mode.

---

# Diagnostic Programming Mode

---

Diagnostic Programming Mode Options		
Abbreviation	Parameter	Description
FR	Flow Rate	Displays the current outlet flow rate
PF	Peak Flow Rate	Displays the highest flow rate measured since the last regeneration
HR	Hours in Service	Displays the total hours that the unit has been in service
VU	Volume Used	Displays the total volume of water treated by the unit
RC	Reserve Capacity	Displays the system's reserve capacity calculated from the system capacity, feedwater hardness, and safety factor
SV	Software Version	Displays the software version installed on the controller

## NOTES:

Some items may not be shown depending on timer configuration.

The timer will exit Diagnostic Mode after 60 seconds if no buttons are pressed.

Press the Extra Cycle button to exit Diagnostic Mode at any time.

## Diagnostic Programming Mode Steps

1. Press the Up and Extra Cycle buttons for five seconds while in service.
2. Use this display to view the current Flow Rate. This option setting is identified by "FR" in the upper left hand corner of the screen.

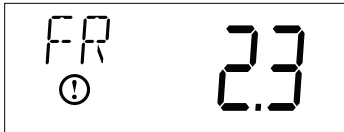

3. Press the Up button. Use this display to view the Peak Flow Rate since the last regeneration cycle. This option setting is identified by "PF" in the upper left hand corner of the screen.

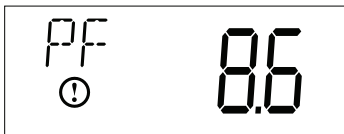

4. Press the Up button. Use this display to view the Hours in Service since the last regeneration cycle. This option setting is identified by "HR" in the upper left hand corner of the screen.

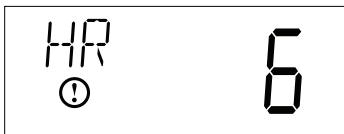

5. Press the Up button. Use this display to view the Volume Used since the last regeneration cycle. This option setting is identified by "VU" in the upper left hand corner of the screen.

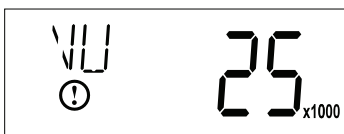

---

## Diagnostic Programming Mode

---

1. Press the Up button. Use this display to view the Reserve Capacity. This option setting is identified by “RC” in the upper left hand corner of the screen.



2. Press the Up button. Use this display to view the Software Version. This option setting is identified by “SV” in the upper left hand corner of the screen.

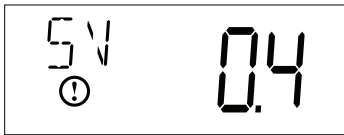

3. Press the Extra Cycle button to end Diagnostic Programming Mode.

# Powerhead Assembly

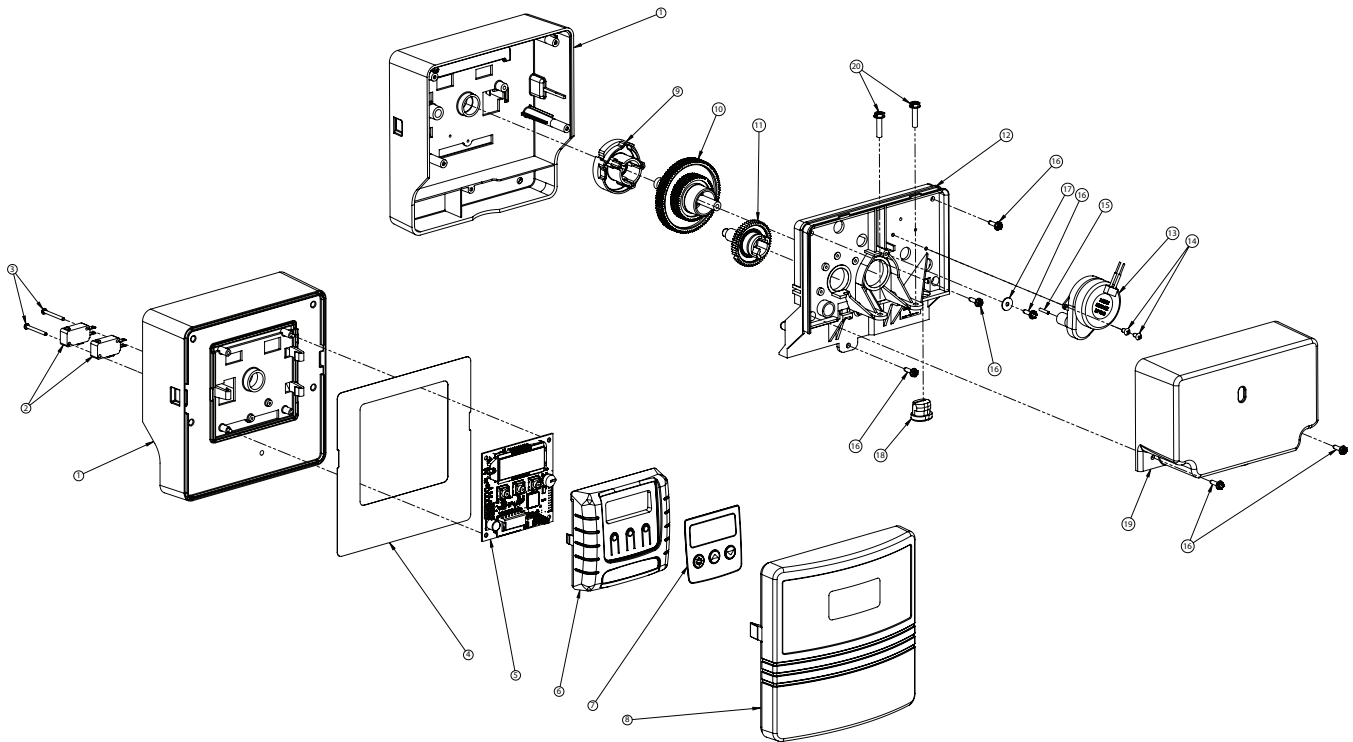

Item No.	Quantity	Part No.	Description
1	1	40269	PLATE, FRONT
2	2	10218	SWITCH, MICRO
3	2	17876	SCREW, PHIL PAN, 4-40 X 1-1/8"
4	1	40326	LABEL, COVER-UP, PROFLOSE
5	1	42196	CIRCUIT BOARD, SXT CONTROL
6	1	42635-01	FRONT COVER, SXT, SQUARE, BLACK
7	1	42637	LABEL, DISPLAY, SXT
8	1	18260	COVER, FRONT
9	1	19928	CAM, SWITCH, UPFLOW
10	1	18211-01	GEAR MAIN, DOWNFLOW, MACHD
11	1	18252	CAM, BRINE VALVE, UPFLOW
12	1	18202	BACK PLATE
13	1	40251	MOTOR, 24V - 50/60HZ
14	2	13602	SCREW, PHIL RD HD, 6-32 X 5/16
15	1	18655	PIN, ROLL, 3/32 X 1/2
16	6	13296	SCREW, HEXWASHER, 6-20 X 1/2
17	1	13363	WASHER, PLAIN, .145 ID SS
18	1	13547	STRAIN RELIEF, ROUND CORD
19	1	18259-02	COVER, BACK, BLACK
20	2	18261	SCREW, HEXWASHER HEAD, #10-24 X .81

**For Service Assembly Numbers, See the Back of this Manual**

# Control Valve Assembly

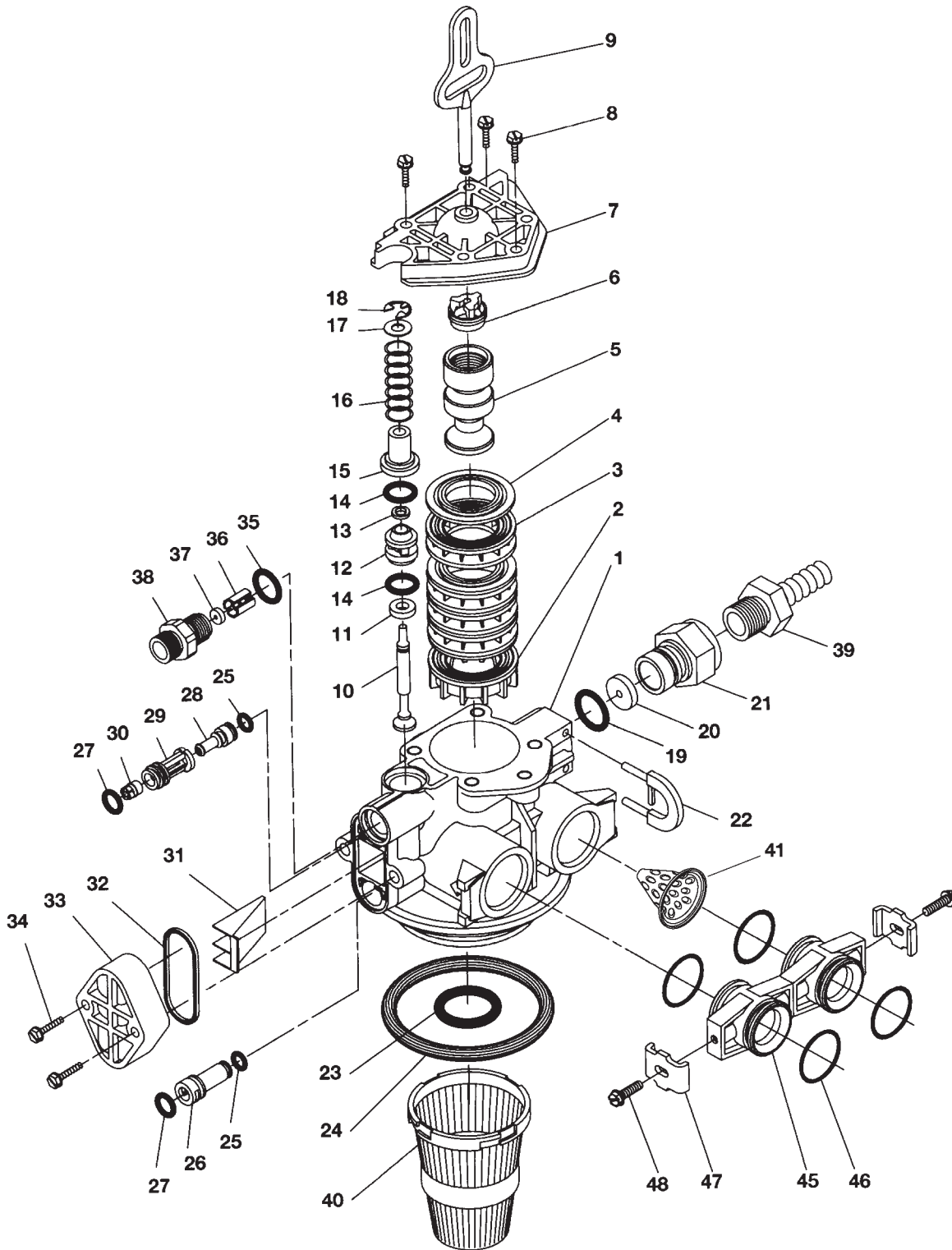



# Control Valve Assembly

Item No.	Quantity	Part No.	Description
1	1	18815-20	VALVE BODY ASSY,5000,W/MIXING
2	1	18264	Spacer, End, 5000
3	4	14241	Spacer, 5600
4	5	13242	Seal, 5600
5	1	18266	PISTON,5000,UPFLOW
6	1	14309	Retainer, Piston Rod
7	1	18268	End Plug Assy
8	3	18261	Screw, Hex Wsh Hd, 10-24 x 13/16
9	1	18267	Rod, Piston
10	1	17978	Brine Valve Stem, 5600, Plastic
11	1	18755	O-ring, Brine Seat
12	1	13167	Spacer, Brine Valve
13	1	12550	Quad Ring, -009
14	2	13302	O Ring, -014
15	1	13165	Cap, Brine Valve
16	1	11973	Spring, Brine Valve
17	1	16098	Washer, Nylon, Brine
18	1	11981-01	Ring, Retaining
19	1	11183	O-Ring, -017
20	1		Flow Washer (specify size)
21	1	11385-01	Housing, Flow Control, Plastic
22	1	18312	Retainer, Drain
23	1	13304	O-Ring, -121
24	1	18303	O-Ring, -336
25	2	10141	O-Ring, -010
26	1	18276	Plug, Injector
27	2	13771	O-Ring, -012
28	1	18275-X	Throat, Injector (specify size) 000, 00, 0, 1, 2, 3
29	1	18274-X	Nozzle, Injector (specify size) 000, 00, 0, 1, 2, 3
30	1	18273	Vortex, Generator
31	1	18271	Screen, Injector, 5000
32	1	40064	Seal, Injector, 4200
33	1	18278-20	INJECTOR CAP ASSY,1610, REGULATED,5000,20 PSI,BLACK
	1	18278-30	INJECTOR CAP ASSY,1610, REGULATED,5000 30 PSI,GRAY
34	2	18262	Screw, Hex Wsh Hd, 10-24 x 1
35	1	12977	O-Ring, -015
36	1	13245	Retainer, BLFC
37	1		Flow Washer (specify size)
38	1	13244	Adapter, BLFC
39	1	13308	Fitting, Hose Barb, Black
	1	12338	Fitting, Elbow, 90 Deg, 1/2 Black
40	1	18280	Collector, Top, 1" x .011 Gray Bayonet
	1	18280-01	Collector, Top, 1" x .020, White Wide Slot, Bayonet
	1	18280-02	Collector, Top, 1" x .008, Red Narrow Slot, Bayonet
41	1	14613	Flow Straightener

**Filter Only (Not Shown)**

.....1	13857	Injector Plug Assy, w/O-ring
.....1	13918	Plug, BLFC Module
.....1	18276-01	INJECTOR ASSY,PLUG,W/O-RINGS

**OPTION - Adapter Coupling Day Clock Only**

45	2	19228	Coupling, Adapter
46	4	13305	O-Ring, -119
47	2	13255	Clip, Mounting
48	2	13314	Screw, Slot Ind Hex, 18-8 x .60

**For Service Assembly Numbers, See the Back of this Manual**

# 3/4" Turbine Meter Assembly

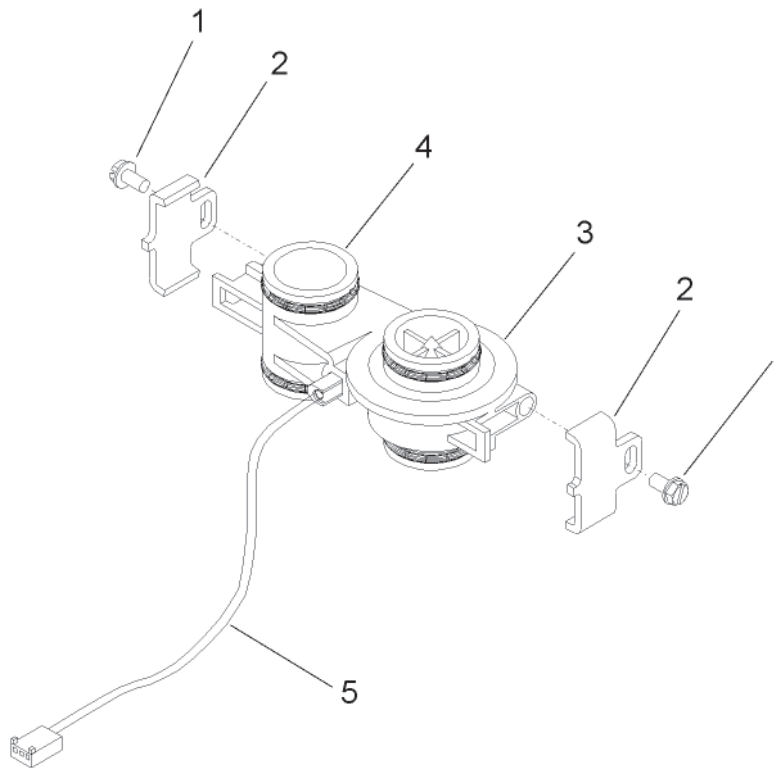

Item No.	Quantity	Part No.	Description
1.....	2 .....	13314 .....	Screw, Hex Washer, 8-18 x 5/8
2.....	2 .....	19569 .....	Clip, Flow Meter
3.....	1 .....	19797 .....	Meter Body Assembly, 3/4" Turbine
4.....	4 .....	13305 .....	O-ring, 119
5.....	1 .....	19791-01 .....	Harness Assembly, Flow Meter
.....	1 .....	19791-02 .....	Meter Cable Assy, 35"

**Not Shown:**

.....	1 .....	14613 .....	Flow Straightener
-------	---------	-------------	-------------------

**For Service Assembly Numbers, See the Back of this Manual**

## Bypass Valve Assembly (Plastic)

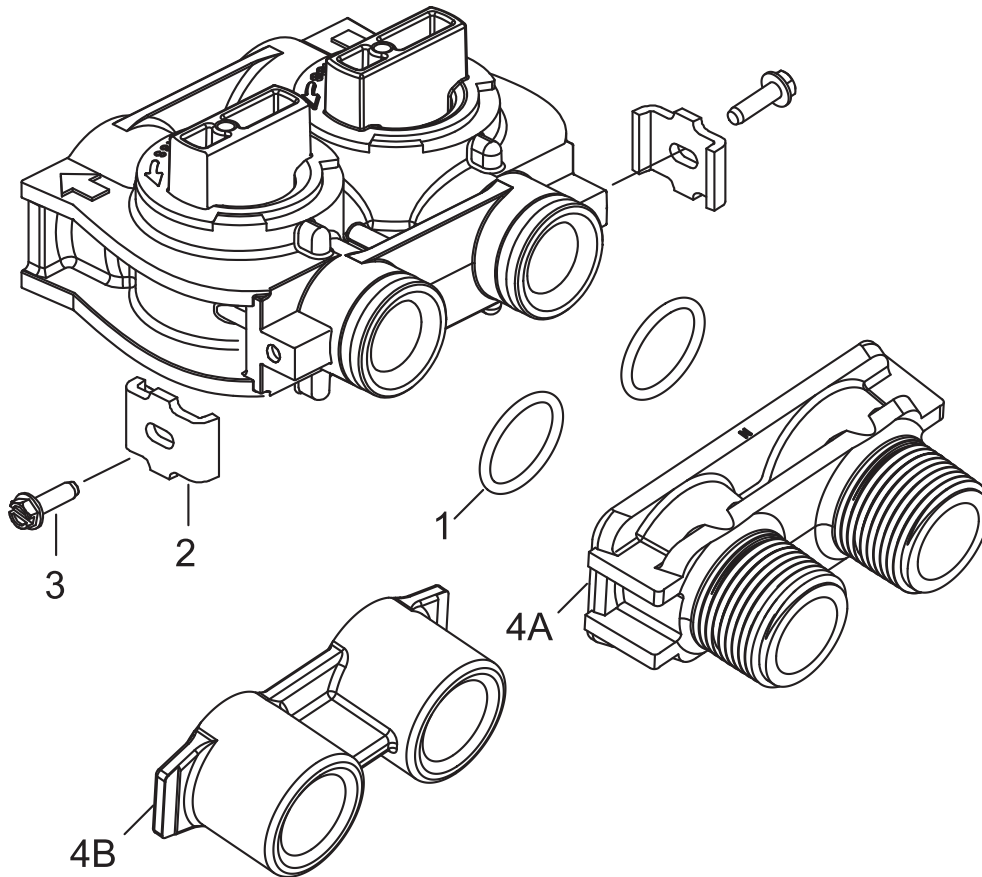

Item No.	Quantity	Part No.	Description
1.....	2	13305	O-ring, -119
2.....	2	13255	Clip, Mounting
3.....	2	13314	Screw, Slot Ind Hex, 8-18 x .60
4A.....	1	18706	Yoke, 1", NPT, Plastic
.....		18706-02	Yoke, 3/4", NPT, Plastic
4B.....	1	13708-40	Yoke, 1", Sweat
.....		13708-45	Yoke, 3/4", Sweat
.....		19275	Yoke, Angle 90 Deg, 3/4", NPT
.....		19275-45	Yoke, Angle 90 Deg, 3/4" Sweat
.....		19620-01	Yoke Assy, 3/4", R/Angle, 90 Deg w/O-rings, Clips & screws
.....		40636	Yoke, 1 1/4", NPT
.....		40636-49	Yoke, 1 1/4", Sweat
.....		41027-01	Yoke, 3/4", NPT, Cast, Machd
.....		41026-01	Yoke, 1", NPT, Cast, Machd, SS

**For Service Assembly Numbers, See the Back of this Manual**

# Bypass Valve Assembly (Metal)

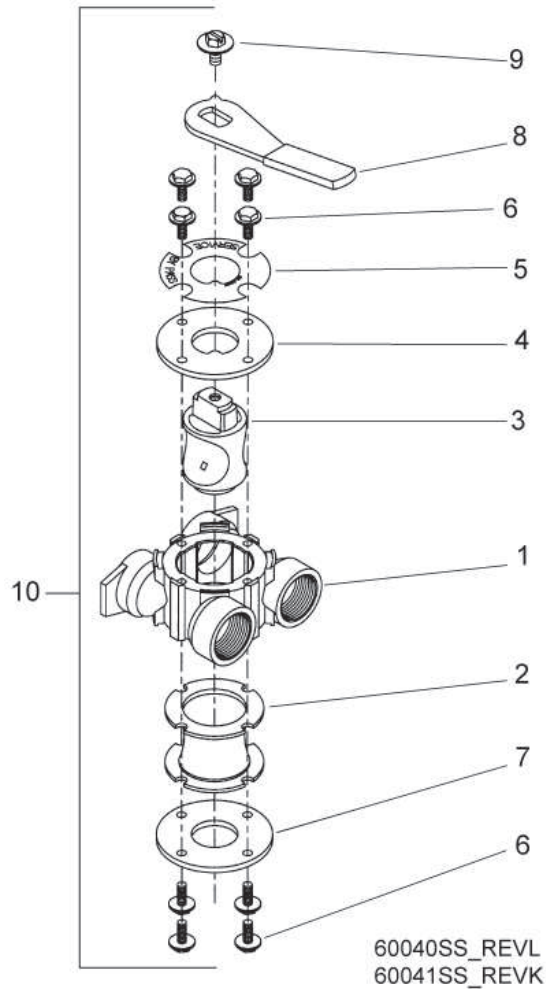

Item No.	Quantity	Part No.	Description
1.....	1.....	40614.....	By-Pass Body, 3/4"
.....	.....	40634.....	By-Pass Body, 1", SS
2.....	1.....	14105.....	Seal, By-Pass, 560CD
3.....	1.....	11972.....	Plug, Bypass, w/Wax
4.....	1.....	11978.....	Plate, Bypass, Top
5.....	1.....	13604-01.....	Label, Bypass, Standard Mount
6.....	8.....	15727.....	Screw, Hex Wsh Hd, 10-24 x 1/2
7.....	1.....	11986.....	Plate, Bypass, Bottom
8.....	1.....	11979.....	Lever, Bypass
9.....	1.....	11989.....	Screw, Sltd Indent, 1/4 - 14 x 1 1/2
10.....	1.....	60040SS.....	Bypass Valve, 5600, 3/4" NPT Blk Grip Lever, Stainless Steel
.....	.....	60041SS.....	Bypass Valve, 5600, 1" NPT Blk Grip Lever, Stainless Steel

**For Service Assembly Numbers, See the Back of this Manual**

# 2300 Safety Brine Valve

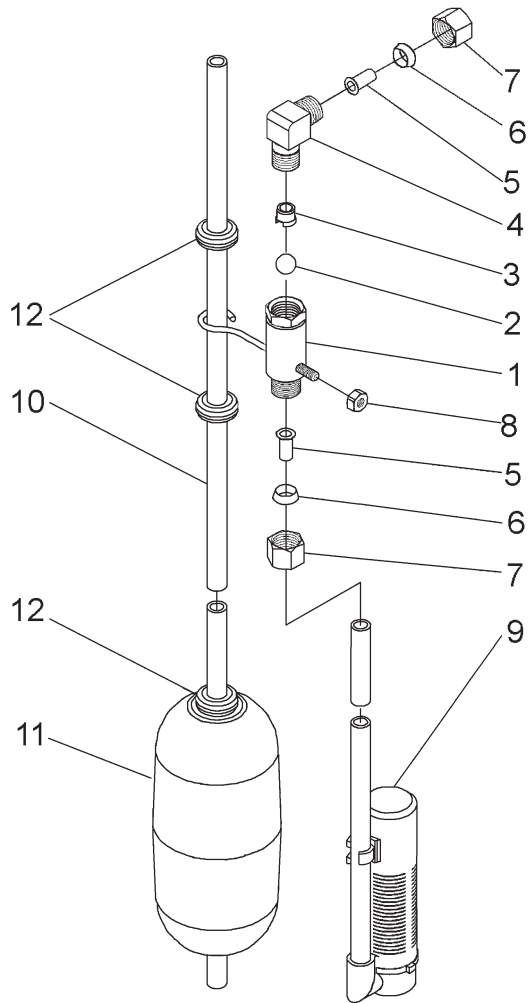

Item No.	Quantity	Part No.	Description
1.....	1.....	60027-00.....	Safety Brine Valve, 2300, Less Elbow
2.....	1.....	10138.....	Ball, 3/8", Brass
3.....	1.....	11566.....	Ball Stop, Slow Fill
4.....	1.....	10328.....	Fitting, Elbow, 90 Deg. 1/4 NPT x 3/8T
5.....	1.....	10332.....	Fitting, Insert, 3/8
6.....	1.....	10330.....	Fitting, Sleeve, 3/8 Celcon
7.....	1.....	10329.....	Fitting, Tube, 3/8 Nut, Brass
8.....	1.....	10186.....	Nut, Hex, 10-32
9.....	1.....	60002-34.....	Air Check, #500, 34" Long
		60003-34.....	Air Check, #500, HW, 34" Tube
10.....	1.....	10149.....	Rod, Float
11.....	1.....	10700.....	Float Assy, White
12.....	3.....	10150.....	Grommet, .30 Dia

**For Service Assembly Numbers, See the Back of this Manual**

# 2310 Safety Brine Valve

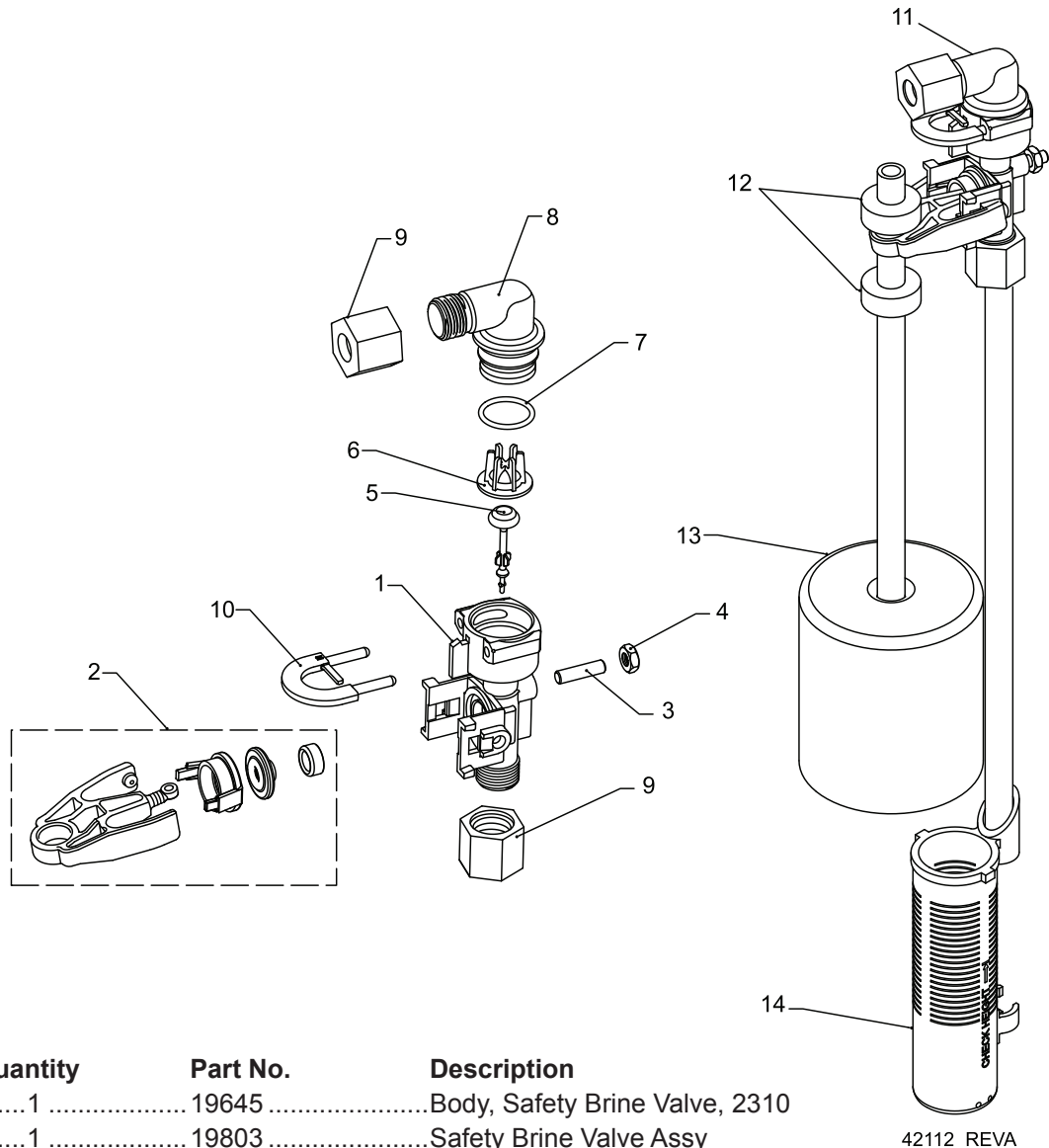

42112\_REVA

Item No.	Quantity	Part No.	Description
1.....	1	19645	Body, Safety Brine Valve, 2310
2.....	1	19803	Safety Brine Valve Assy
3.....	1	19804	Screw, Sckt Hd, Set, 10-24 x .75
4.....	1	19805	Nut, Hex, 10-24, Nylon Black
5.....	1	19652-01	Poppet Assy, SBV w/O-Ring
6.....	1	19649	Flow Dispenser
7.....	1	11183	O-Ring, -.017
8.....	1	19647	Elbow, Safety Brine Valve
9.....	2	19625	Nut Assy, 3/8" Plastic
10.....	1	18312	Retainer, Drain
11.....	1	60014	Safety Brine Valve Assy, 2310
12.....	2	10150	Grommet, .30 Dia
13.....	1	60068-30	Float Assy, 2310, w/30" Rod
14.....	1	60002-34	Air Check, #500, 34" Long

**For Service Assembly Numbers, See the Back of this Manual**

## Troubleshooting

<b>Problem</b>	<b>Cause</b>	<b>Correction</b>
1. Water conditioner fails to regenerate.	A. Electrical service to unit has been interrupted	A. Assure permanent electrical service (check fuse, plug, pull chain, or switch)
	B. Timer is defective.	B. Replace timer.
	C. Power failure.	C. Reset time of day.
2. Hard water.	A. By-pass valve is open.	A. Close by-pass valve.
	B. No salt is in brine tank.	B. Add salt to brine tank and maintain salt level above water level.
	C. Injector screen plugged.	C. Clean injector screen.
	D. Insufficient water flowing into brine tank.	D. Check brine tank fill time and clean brine line flow control if plugged.
	E. Hot water tank hardness.	E. Repeated flushings of the hot water tank is required.
	F. Leak at distributor tube.	F. Make sure distributor tube is not cracked. Check O-ring and tube pilot.
	G. Internal valve leak.	G. Replace seals and spacers and/or piston.
3. Unit used too much salt.	A. Improper salt setting.	A. Check salt usage and salt setting.
	B. Excessive water in brine tank.	B. See problem 7.
4. Loss of water pressure.	A. Iron buildup in line to water conditioner.	A. Clean line to water conditioner.
	B. Iron buildup in water conditioner.	B. Clean control and add mineral cleaner to mineral bed. Increase frequency of regeneration.
	C. Inlet of control plugged due to foreign material broken loose from pipes by recent work done on plumbing system.	C. Remove piston and clean control.
5. Loss of mineral through drain line.	A. Air in water system.	A. Assure that well system has proper air eliminator control. Check for dry well condition.
	B. Improperly sized drain line flow control.	B. Check for proper drain rate.
6. Iron in conditioned water.	A. Fouled mineral bed.	A. Check backwash, brine draw, and brine tank fill. Increase frequency of regeneration. Increase backwash time.
7. Excessive water in brine tank.	A. Plugged drain line flow control.	A. Clean flow control.
	B. Plugged injector system.	B. Clean injector and screen.
	C. Timer not cycling.	C. Replace timer.
	D. Foreign material in brine valve.	D. Replace brine valve seat and clean valve.
	E. Foreign material in brine line flow control.	E. Clean brine line flow control.

---

## Troubleshooting

---

<b>Problem</b>	<b>Cause</b>	<b>Correction</b>
8. Softener fails to draw brine.	A. Drain line flow control is plugged.	A. Clean drain line flow control.
	B. Injector is plugged.	B. Clean injector
	C. Injector screen plugged.	C. Clean screen.
	D. Line pressure is too low.	D. Increase line pressure to 20 P.S.I.
	E. Internal control leak	E. Change seals, spacers, and piston assembly.
	F. Service adapter did not cycle.	F. Check drive motor and switches.
9. Control cycles continuously.	A. Misadjusted, broken, or shorted switch.	A. Determine if switch or timer is faulty and replace it, or replace complete power head.
10. Drain flows continuously.	A. Valve is not programming correctly.	A. Check timer program and positioning of control. Replace power head assembly if not positioning properly.
	B. Foreign material in control.	B. Remove power head assembly and inspect bore. Remove foreign material and check control in various regeneration positions.
	C. Internal control leak.	C. Replace seals and piston assembly.



## Error Codes

**Note:** Error codes appear on the In Service display.

Error Code	Probable Cause	Recover and Resetting
[Err 0]	Drive motor is stalled	Unplug the unit from the power source
[Err 1]	Drive motor is running continuously	When power is restored to the unit, the Err _ display code clears. If the condition causing the error has not been resolved the Err _ code reappears in the four digit display. Do not attempt to troubleshoot this problem any further.
[Err 2]	<p>There have been more than 99 days since the last Regeneration. If the Day of the Week mode of regeneration is selected and days since last regeneration exceeds 7 days.</p> <p><b>[ 7 - - 5 ]:</b> There have been more than 7 days since the last regeneration. All individual settings (d1, d2, d3, d4, d5, d6, d7) are set to 0.</p>	<p>Regeneration must occur for the unit to recover, the display to clear and the valve to function normally.</p> <p><b>[ 7 - - 5 ]:</b> To recover from [Err2], the user must initiate a regeneration or set at least one individual day to 1.</p>
[Err 3]	Control board memory failure.	Perform a Master Reset. If the error returns, do not attempt to troubleshoot this problem any further.

## Error Display Example



**NOTE:** Unit will flash when an error exists.

---

# Water Conditioner Flow Diagrams

---

## Service Position

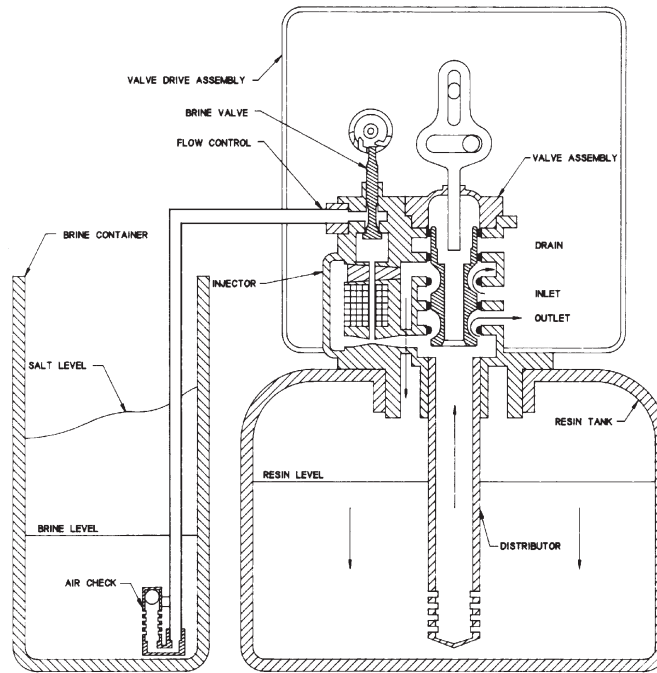

## 1. Brine Draw / Slow Rinse Position

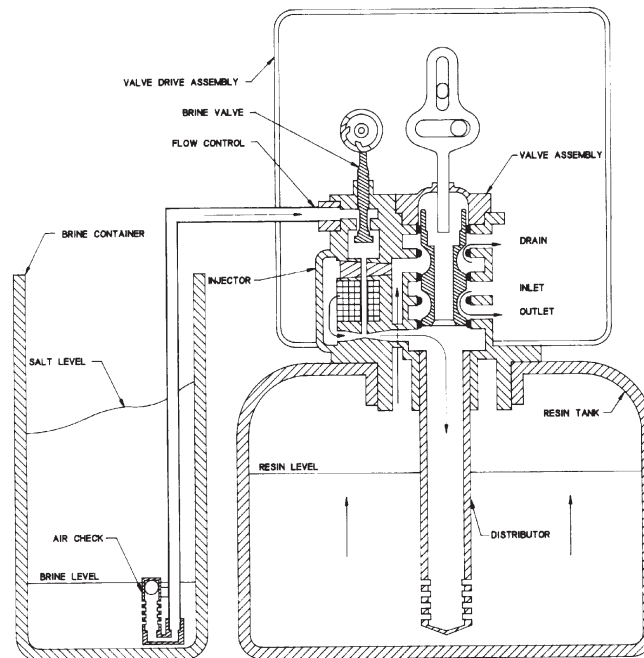

---

# Water Conditioner Flow Diagrams

---

## 2. Backwash

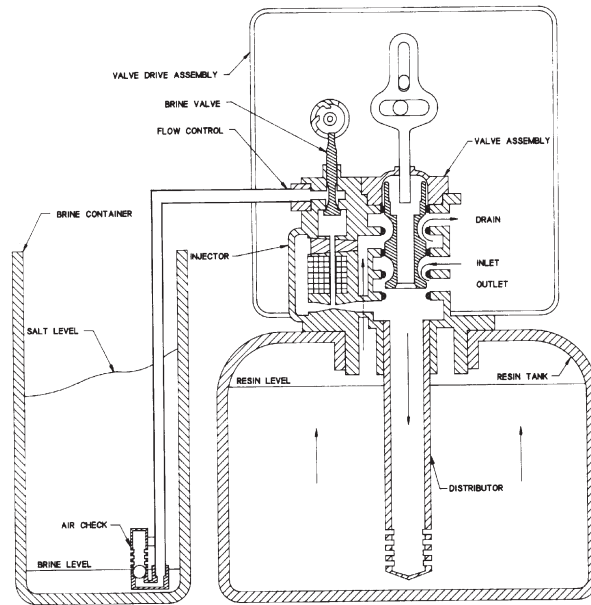

## 3. Rapid Rinse

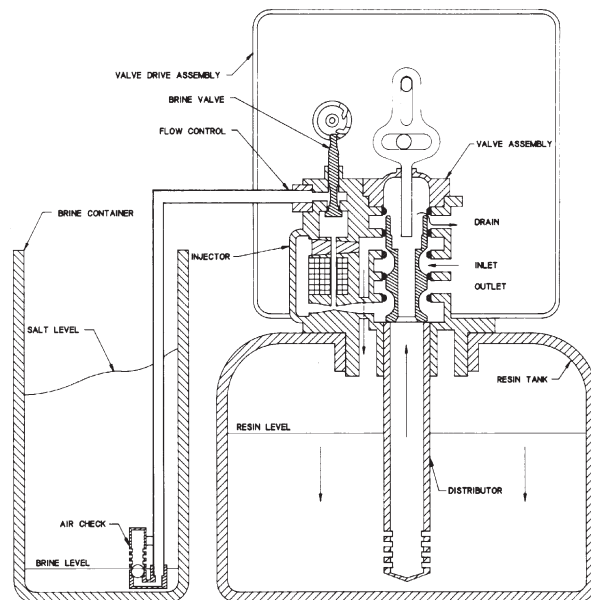

---

# Water Conditioner Flow Diagrams

---

## 4. Brine Tank Fill

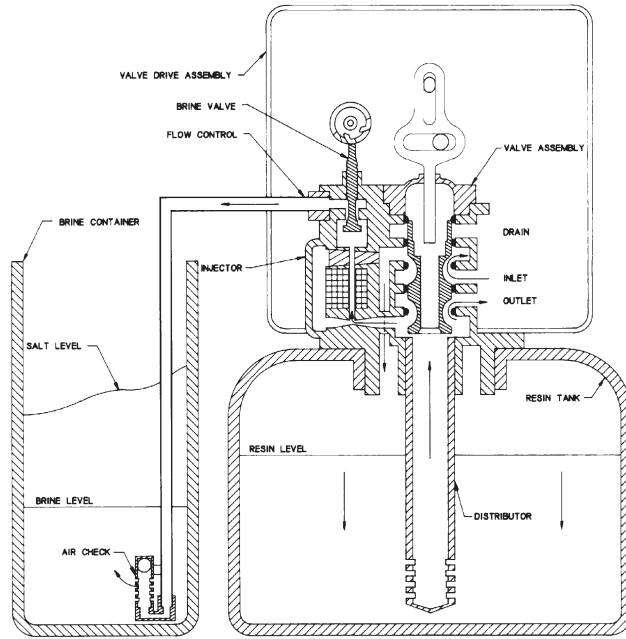

# Flow Data, Injector Draw & Slow Rinse Rates

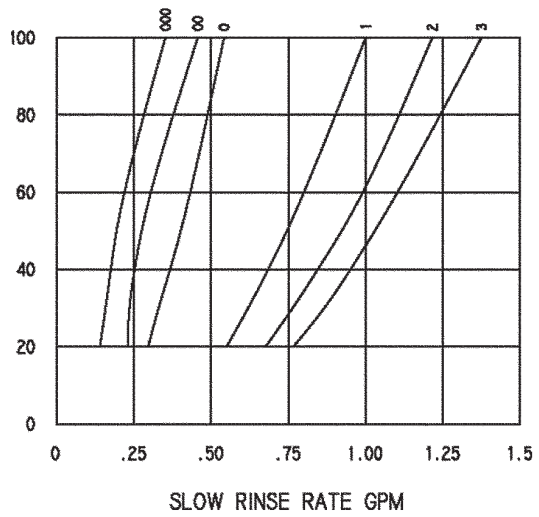
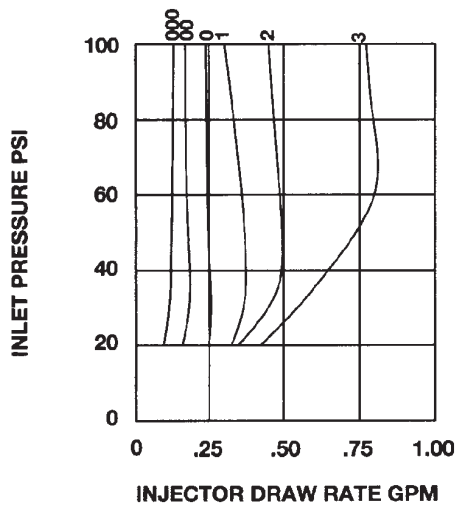
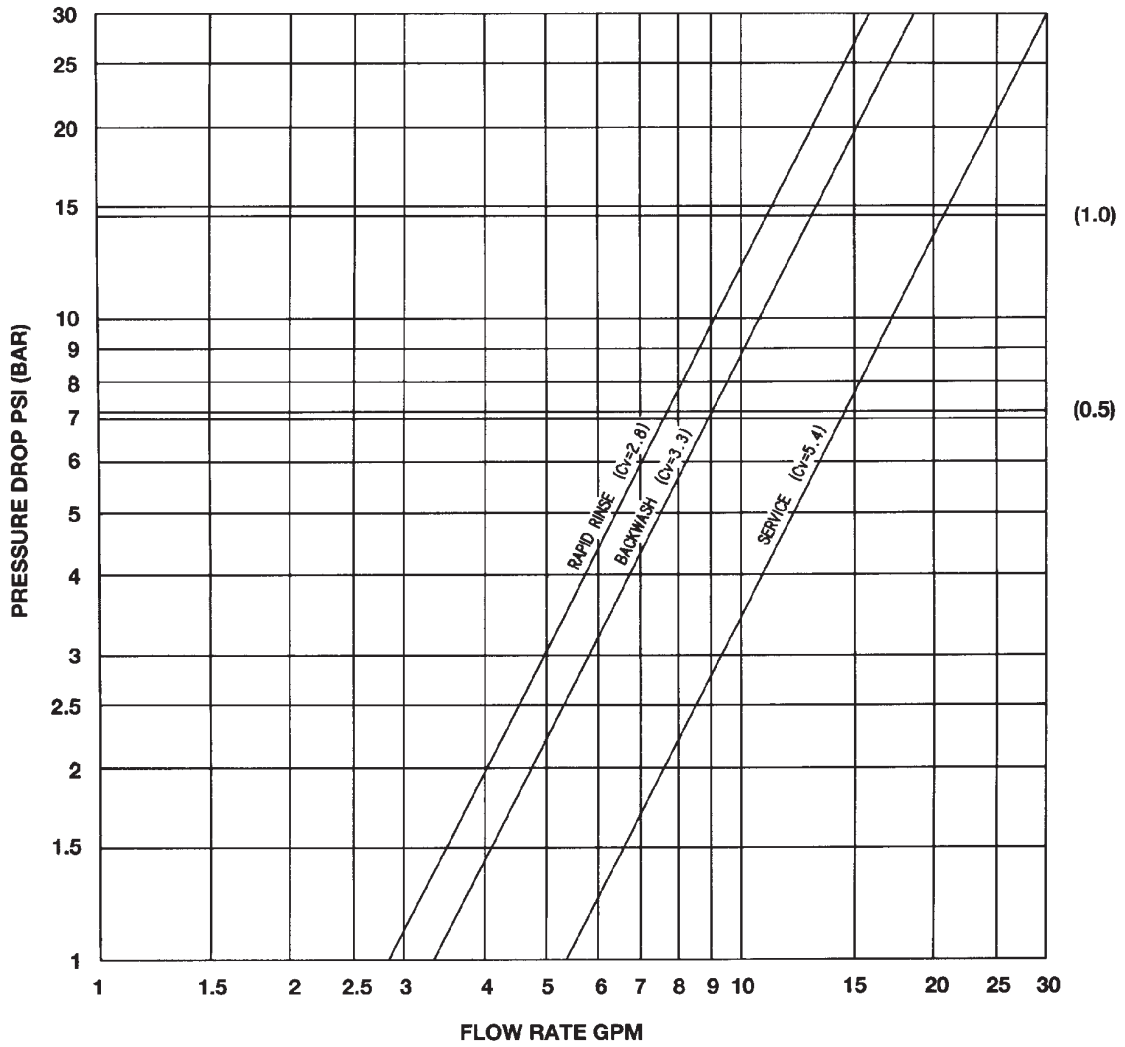

# Dimensional Drawing

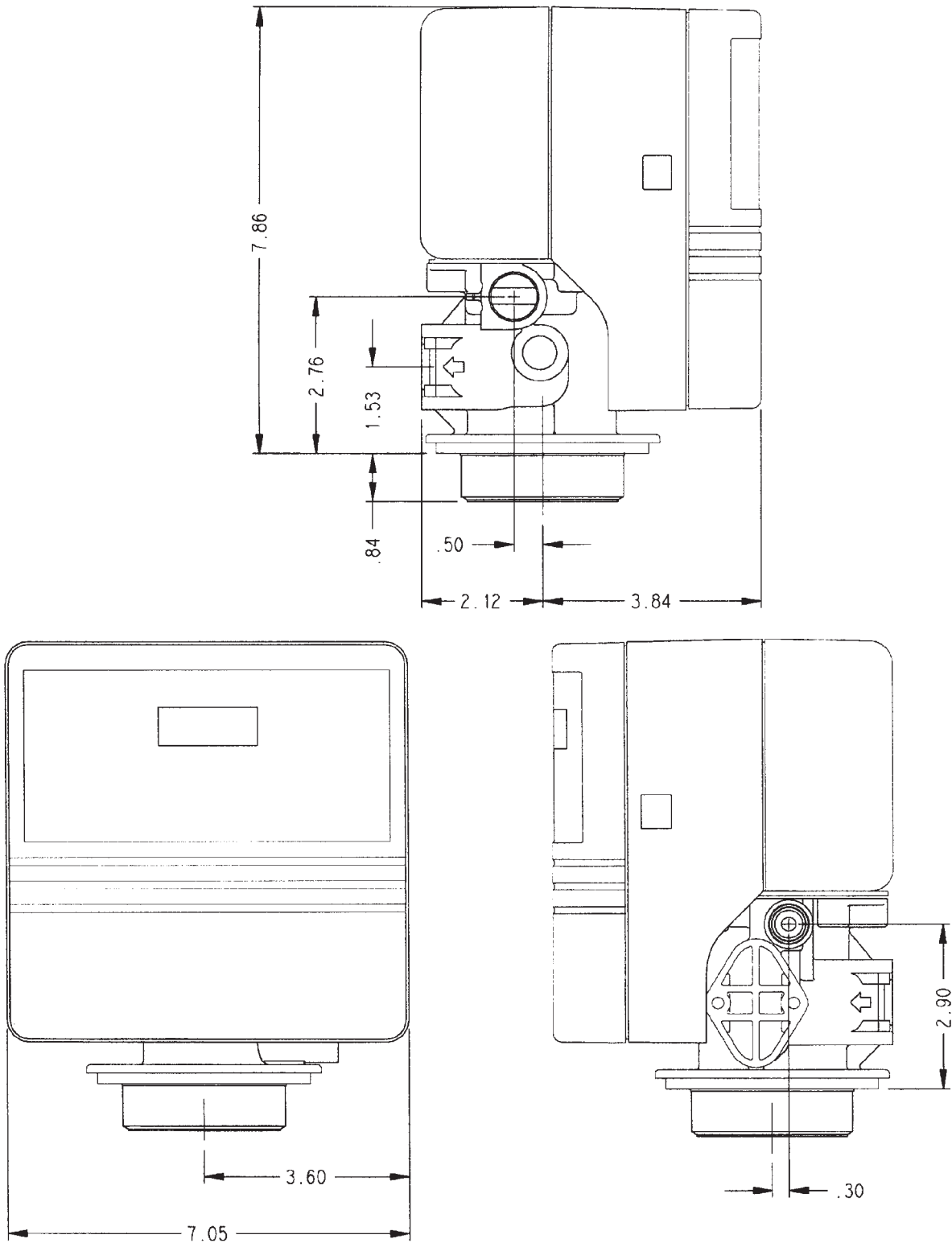

# Wiring Diagram

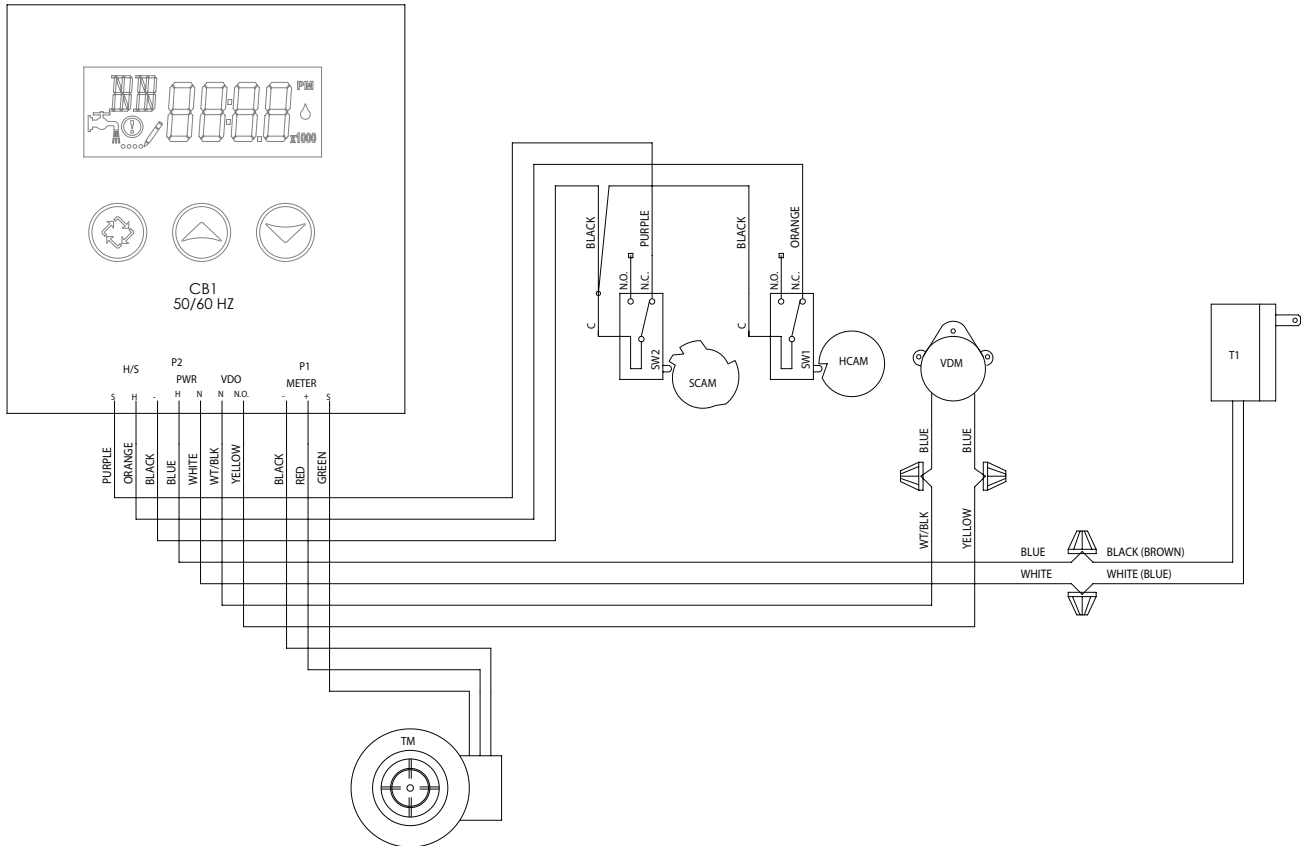

- CB1 - SXT Timer
- T1 - 24V Transformer
- TM - 3/4" Turbine Flow Meter (Optional)
- VDM - Valve Drive Motor
- SW1 - Valve Homing Switch
- SW2 - Valve Step Switch
- HCAM - Valve Homing
- SCAM - Valve Step

---

# Service Instructions

---

## Replacing Brine Valve, Injectors and Screen

1. Turn off water supply to conditioner:  
If the conditioner installation has a “three valve” bypass system, first open the valve in the bypass line, then close the valves at the conditioner inlet and outlet.  
If the conditioner has an integral bypass valve, put it in the Bypass position.  
If there is only a shut-off valve near the conditioner inlet, close it.
2. Relieve water pressure in the conditioner by stepping the control into the Backwash position momentarily. Return the control to the In Service position.
3. Unplug electrical cord from outlet.
4. Disconnect brine tube and drain line connections at the injector body.
5. Remove the two injector body mounting screws. The injector and brine module can now be removed from the control valve. Remove and discard brine body o-rings.

## Brine Valve Replacement

1. Pull brine valve from injector body. Also remove and discard o-ring at bottom of brine valve hole.
2. Apply silicone lubricant to new o-ring and reinstall at bottom of brine valve hole.
3. Apply silicone lubricant to o-ring on new valve assembly and press into brine valve hole. Be sure shoulder on bushing is flush with injector body.

## Injectors/Screen Replacement

1. Remove injector cap and screen, discard o-ring. Unscrew injector nozzle and throat from injector body.
2. Screw in new injector throat and nozzle, be sure they are sealed tightly. Install a new screen.
3. Apply silicone lubricant to new o-ring and install around oval extension on injector cap.
4. Apply silicone lubricant to three new o-rings and install over three bosses on injector body.
5. Insert screws thorough injector cap and injector. Place this assembly thorough hole in timer housing and into mating holes in the valve body. Tighten screws.
6. Reconnect brine tube and drain line.
7. Return bypass or inlet valving to normal In Service position. Water pressure automatically builds in the conditioner.

**NOTE: Be sure to shut off any bypass line.**

8. Check for leaks at all seal areas. Check drain seal with the control in the Backwash position.
9. Plug electrical cord into outlet.
10. Set Time Of Day and cycle the control valve manually to assure proper function. Make sure control valve is returned to the In Service position.
11. Be sure there is enough salt in the brine tank.
12. Start regeneration cycle manually if water is hard.



### Timer Replacement

To replace timer refer to Replacing Brine Valve, Injectors and Screen, steps 1–3.

1. Remove the control valve back cover. Disconnect the meter cable from the meter assembly.
2. Remove screw and washer at drive yoke. Remove timer mounting screws. The entire timer assembly then lifts off easily.
3. Put new timer on top of valve. Be sure drive pin on main gear engages slot in drive yoke.
4. Replace timer mounting screws. Replace screw and washer at drive yoke. Replace meter signal wire.
5. Return bypass or inlet valving to normal In Service position. Water pressure automatically builds in the conditioner.

**NOTE: Be sure to shut off any bypass line.**

6. Replace the control valve back cover.
7. Follow Injectors/Screen Replacement, steps 9–12.

### Piston Assembly Replacement

To replace piston assembly refer to Replacing Brine Valve, Injectors and Screen, steps 1–3.

1. Remove the control valve back cover. Disconnect the meter cable from the meter assembly.
2. Remove screw and washer at drive yoke. Remove timer mounting screws. The entire timer assembly will now lift off easily. Remove end plug retainer plate.
3. Pull upward on end of piston yoke until assembly is out of valve.
4. Inspect the inside of the valve to make sure that all spacers and seals are in place, and that there is no foreign matter that would interfere with the valve operation.
5. Take new piston assembly as furnished and push piston into valve by means of the end plug. Twist yoke carefully in a clockwise direction to properly align it with drive gear. Replace end plug retainer plate.
6. Place timer on top of valve. Be sure drive pin on main gear engages slot in drive yoke.
7. Replace timer mounting screws. Replace screw and washer at drive yoke.
8. Return bypass or inlet valving to normal In Service position. Water pressure automatically builds in the conditioner.

**NOTE: Be sure to shut off any bypass line.**

9. Replace the control valve back cover.
10. Follow Injectors/Screen Replacement, steps 9–12.

---

## Service Instructions

---

### Seal and Spacer Replacement

To replace seals and spacers, refer to Replacing Brine Valve, Injectors and Screen, steps 1–3.

1. Remove the control valve back cover. Disconnect the meter cable from the meter assembly.
2. Remove screw and washer at drive yoke. Remove timer mounting screws. The entire timer assembly will now lift off easily. Remove end plug retainer plate.
3. Pull upward on end of piston rod yoke until assembly is out of valve. Remove and replace seals and spacers.
4. Take piston assembly and push piston into valve by means of the end plug. Twist yoke carefully in a clockwise direction to properly align it with drive gear. Replace end plug retainer plate.
5. Place timer on top of valve. Be sure drive pin on main gear engages slot in drive yoke.
6. Replace timer mounting screws. Replace screw and washer at drive yoke.
7. Return bypass or inlet valving to normal In Service position. Water pressure automatically builds in the conditioner.

**NOTE: Be sure to shut off any bypass line.**

8. Replace the control valve back cover.
9. Follow Injectors/Screen Replacement, steps 9–12.

### Meter Replacement

To replace meter refer to Replacing Brine Valve, Injectors and Screen, steps 1–3.

1. Remove two screws and clips at bypass valve or yoke. Pull resin tank away from plumbing connections.
2. Pull meter module out of control valve.
3. Remove the meter cable from the meter module.
4. Apply silicone lubricant to four new o-rings and assemble to four ports on new meter module.
5. Install signal wire into new meter module.
6. Assemble meter to control valve. Note, meter portion of module must be assembled at valve outlet.
7. Push resin tank back to the plumbing connections and engage meter ports with bypass valve or yoke.
8. Attach two clips and screws at bypass valve or yoke. Be sure clip legs are firmly engaged with lugs.
9. Return bypass or inlet valving to normal In Service position. Water pressure automatically builds in the conditioner.

**NOTE: Be sure to shut off any bypass line.**

10. Check for leaks at all seal areas.
11. Follow Injectors/Screen Replacement, steps 9–12.

---

# Service Assemblies

---

## AIR CHECK

60002-34 ..... AIR CHECK,#500,34" LONG

## BRINE LINE FLOW CONTROLS (BLFC)

60022-12 ..... BLFC, .125 GPM,5000/5600/9000  
60022-25 ..... BLFC, .25 GPM,5000/5600/9000  
60022-50 ..... BLFC, .50 GPM,5000/5600/9000  
60022-100 ..... BLFC, 1.0 GPM,5000/5600/9000  
60022-12 ..... BLFC, .125 GPM,5000/5600/9000  
60022-25 ..... BLFC, .25 GPM,5000/5600/9000  
60022-50 ..... BLFC, .50 GPM,5000/5600/9000

## BRINE LINE FLOW CONTROL WASHERS

17307 ..... WASHER, FLOW, .125 GPM  
12094 ..... WASHER, FLOW, .25 GPM  
10759 ..... LABEL, .5 GPM, 1.5 LBS SALT/MIN  
12097 ..... WASHER, FLOW, 1.0 GPM

## BRINE VALVE

60032 ..... BRINE VALVE, 4600/5600

## BYPASSES

60040SS ..... BYPASS VALVE, 5600, 3/4" NPT, BLK GRIP  
..... LEVER, STAINLESS STEEL  
60041SS ..... BYPASS VALVE, 5600, 1" NPT, BLK GRIP  
..... LEVER, STAINLESS STEEL  
60049 ..... 3/4" BYPASS, PLASTIC

## COLLECTORS, UPPER

18280 ..... COLLECTOR, TOP, 1" X .011, GRAY BAYONET  
18280-01 ..... COLLECTOR, TOP, 1" X .020, WHITE  
..... WIDE SLOT BAYONET  
18280-02 ..... COLLECTOR, TOP, 1" X .008, RED  
..... NARROW SLOT, BAYONET

## COVER

18260-00 ..... COVER, FRONT, SMOKE

## DISTRIBUTORS

60795-00 ..... DISTRIBUTOR ASSY, 1", STD, GRAY, .011,  
..... W/72" TUBE  
60795-01 ..... DISTRIBUTOR ASSY, 1", WIDE, WHITE,  
..... .020, W/72" TUBE  
60795-02 ..... DISTRIBUTOR ASSY, 1" NARROW, RED  
..... .008, W/72" TUBE

## DRAIN LINE FLOW CONTROLS

60705-XX ..... DRAIN LINE FLOW CONTROL  
..... (FROM .6 - 7.0 GPM)  
60706-XX ..... DRAIN LINE FLOW CONTROL W/QUICK  
..... CONNECT (FROM 8-15 GPM)  
60700-XX ..... DRAIN LINE FLOW CONTROL (8-15 GPM)

## DRAIN LINE FLOW CONTROL WASHERS

19153 ..... .06 GPM  
19152 ..... .08 GPM  
19151 ..... 1.0 GPM  
12085 ..... 1.2 GPM  
19150 ..... 1.3 GPM  
12086 ..... 1.5 GPM  
19149 ..... 1.7 GPM  
12087 ..... 2.0 GPM  
12088 ..... 2.4 GPM  
12089 ..... 3.0 GPM  
12090 ..... 3.5 GPM  
12091 ..... 4.0 GPM  
19147 ..... 4.5 GPM  
12092 ..... 5.0 GPM  
17814 ..... 6.0 GPM  
12408 ..... 7.0 GPM  
17943 ..... 8.0 GPM  
17944 ..... 9.0 GPM  
16529 ..... 10 GPM  
16735 ..... 12 GPM  
16736 ..... 15 GPM

## FLOATS

60068-30 ..... FLOAT ASSY, 2310, W/30" ROD

## METER MODULE

60626 ..... METER ASSY, TURBINE, ELECTRONIC, 3/4"  
..... WITH CLIPS AND SCREWS  
19797 ..... METER ASSY, 3/4" DUAL PORT, SLP,  
..... ELEC, PLAS, TURB, W/O CLPS&SCRS

## INJECTORS (1610)

18272-000 ..... #000 BROWN INJECTOR  
18272-00 ..... #00 VIOLET INJECTOR  
18272-0 ..... #0 RED INJECTOR  
18272-1 ..... #1 WHITE INJECTOR  
18272-2 ..... #2 BLUE INJECTOR

## PISTON

60115-10 ..... PISTON ASSEMBLY

## SAFETY BRINE VALVE

60014 ..... 2310 PLASTIC

## SALES & SERVICE AIDS

40734 ..... SPEC SHEET  
40272 ..... SERVICE MANUAL

## SEALS & SPACERS

60120 ..... SEAL AND SPACER KIT

## SERVICE EQUIPMENT

12763 ..... STUFFER TOOL ASSY, 5600/9000  
12874 ..... HOOK, SEAL  
13061 ..... PULLER ASSY, PORT RING  
16174 ..... SILICONE GREASE, 2 OZ. TUBE  
16586-8 ..... SILICONE GREASE, 8 LB. PAIL  
41891 ..... WRENCH, PLASTIC BY-PASS

## TIMER

42739 ..... TIMER ASSY, SXT, PROFLO

## YOKES

13708 ..... 3/4" NPT  
13708-10 ..... 3/4" BSP  
13708NP ..... 3/4" NPT, NICKEL PLATED  
13708-10NP ..... 3/4" BSP, NICKEL PLATED  
13708-45 ..... 3/4" SWEAT  
13708-45NP ..... 3/4" SWEAT, NICKEL PLATED  
13708-40 ..... 1" SWEAT  
13708-40NP ..... 1" SWEAT, NICKEL PLATED  
13398 ..... 1" NPT  
13398-10 ..... 1" BSP  
13398NP ..... 1" NPT, NICKEL PLATED  
13398-10NP ..... 1" BSP, NICKEL PLATED  
18706 ..... 1" PLASTIC, MNPT  
18706-10 ..... 1" PLASTIC, MBSP  
18706-02 ..... 3/4" PLASTIC, MNPT  
18706-12 ..... 3/4" PLASTIC, MBSP  
19275 ..... 3/4" 90 DEG ANGLE, NPT  
19275-10 ..... 3/4" 90 DEG ANGLE, BSP  
19275NP ..... 3/4" 90 DEG ANGLE, NPT, NICKEL PLATED  
19275-10NP ..... 3/4" 90 DEG ANGLE, BSP, NICKEL PLATED  
19275-45 ..... 3/4" 90 DEG ANGLE SWEAT  
19275-45NP ..... 3/4" 90 DEG ANGLE SWEAT, NICKEL PLATED  
19620-01 ..... 90 DEG ADAPTER COUPLING

