

HYDROMATIC® SKV50 SUBMERSIBLE SEWAGE EJECTOR PUMP

- Residential Sewage
- High-Capacity Sump
- Septic Tank Effluent

Features

The Hydromatic SKV50 submersible pump is specifically designed to meet the demands of residential wastewater and sewage applications, and the quality standards of the professional plumber. The 2 inch NPT discharge pump is available with powerful 1/2 HP performance, in both automatic and manual configurations. The SKV50 can handle capacities up to 180 gallons per minute and heads over 20 feet.

Maximum Efficiency - New PSC motor offers same amp draw as before with better torque and flow.

Clog Resistant Design - High-capacity vortex thermoplastic impeller efficiently handles up to 2 inch spherical solids and features a screenless bottom inlet and pump-out vanes on the back of the impeller that prevent stringy materials from binding the impeller or shaft.

Water Resistant Power Cord - Molded plug is available in 10 or 20 foot lengths.

Cast Iron Construction - Heavy-duty design provides long life by dissipating heat for cooler motor operation.

Low Friction Design - Ball bearing design is oil filled and supports the motor shaft, providing perfect alignment of rotor resulting in less friction and less frequent service intervals.

Mechanical Shaft Seals - Carbon and ceramic faced for long lasting life free of leaking.

Best In Class Warranty - Unparalleled 3 Year Warranty, your guarantee of quality and performance.



New And Improved Diaphragm Switch

Features

- A More Reliable Operation** - New diaphragm design eliminates leakage resulting in reliable on and off points over the life of the switch.
- B Greater Water Protection** - Improved sealing of both the diaphragm and cord entry helps prevent water entering switch housing.
- C Added Corrosion Prevention** - Desiccant pack inside the switch housing stops false pump activation by absorbing any trace of moisture in switch housing.
- D Maximum Durability** - Stronger & thicker housing material is more robust and resistant to abuse.
- E Closed End Insert** - Prevents bracket screw from penetrating the switch housing and completely prevents failure due to the bracket screw penetrating the switch housing.

Quality Assurance From Start To Finish

In an effort to provide our customers with the most reliable switch operation, extensive lab, agency, and field testing was employed at all phases of development to make the best switch possible. Each switch is also checked and tested for on/off points, seals, and vent tube before being leaving our facility, your guarantee of quality and performance.

HYDROMATIC® SKV50 SUBMERSIBLE SEWAGE EJECTOR PUMP

Pump Characteristics

Pump/Motor Unit	Submersible	
Manual Models	SKV50M1	SKV50M2
Automatic Models	SKV50A1	--
Horsepower	1/2	
Full Load Amps	12	6.0
Motor Type	PSC	
R.P.M.	1650	
Phase Ø	1	
Voltage	115	230
Hertz	60	
Operation	Intermittent	
Temperature	140°F Ambient	
Insulation	Class B	
Discharge Size	2" NPT std.	
Solids Handling	2"	
Unit Weight	54 lbs.	
Power Cord	16/3, SJTW, 115V = 10' std. (20' opt.) 230V = 20' std.	

Performance Data

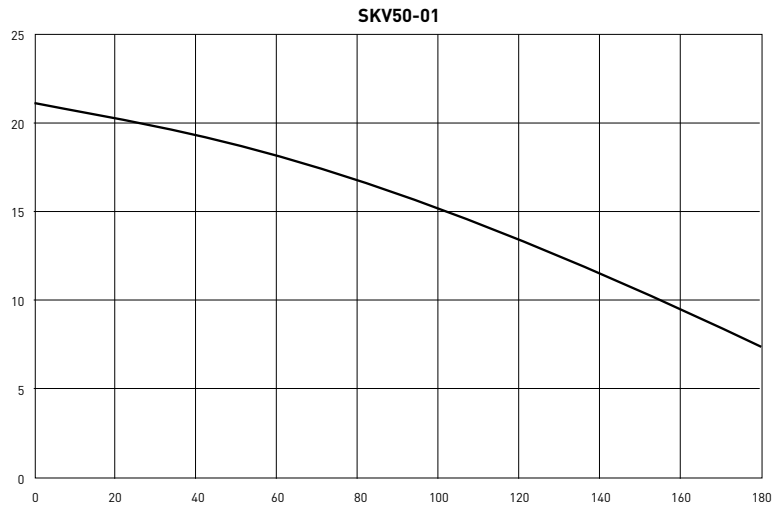

Dimensional Data

SWITCH	DIAPHRAM	TETHERED
PUMP ON	12.85 [325.2]	14.00 [355.6]
PUMP OFF	3.95 [100.3]	7.60 [193.0]

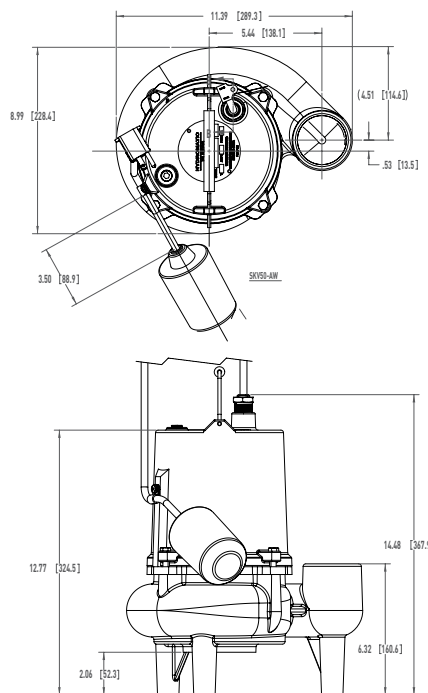

All dimensions in inches. Component dimensions may vary $\pm 1/8$ inch. Dimensional data not for construction purpose unless certified. Dimensions and weights are approximate. On/Off level adjustable.

Materials of Construction

Handle	Steel
Lubricating Oil	Dielectric Oil
Motor Housing	Cast Iron
Seal Plate	Cast Iron
Pump Casing	Cast Iron
Shaft	Stainless Steel
Mechanical Shaft Seal	Seal Faces: Carbon/Ceramic Seal Body: Brass Spring: Stainless Steel Bellows: Buna-N
Impeller	Engineered Thermoplastic
Upper Bearing	Sleeve
Lower Bearing	Single Row Ball Bearing
Fastener	Stainless Steel



USA
293 WRIGHT STREET, DELAVAN, WI 53115 WWW.HYDROMATIC.COM
PH: 888-957-8677 ORDERS FAX: 800-426-9446

CANADA
269 TRILLIUM DRIVE, KITCHENER, ONTARIO, CANADA N2G 4W5
PH: 519-896-2163 ORDERS FAX: 519-896-6337

Because we are continuously improving our products and services, Pentair reserves the right to change specifications without prior notice.