

# 5800 Horizontal Split Case Pumps Performance

## Table of Contents

### Hydraulic Coverage Charts

3600 RPM.....	005
1800 RPM.....	006
1200 RPM.....	007
900 RPM & Below .....	008
Additional Larger Sizes.....	009

#### 3600 RPM

2"-5874 (G2A1B).....	011
3"-5874 (G3A1B).....	011
4"-5874 (G4A1A).....	012
5"-5874 (G5A1A).....	012
2"-5876 (G2B1A).....	013
3"-5876 (G3B1A).....	013
4"-5876 (G4B1A).....	014
5"-5876 (G5B1A).....	014
6"-5876 (G6B1A).....	015

#### 1800 RPM

4"-5821 (D4C1A).....	016
5"-5821 (D5C1B).....	016
6"-5821 (D6C1A).....	017
8"-5821 (D8C1A).....	017
8"-5821 (D8C1C).....	018
10"-5821 (D10C1E).....	018
4"-5822 (D4B1C).....	019
5"-5822 (D5B1K).....	019
6"-5822 (D6B1F).....	020
8"-5822 (D8B1R).....	020
4"-5823 (D4A1C).....	021
5"-5823 (D5A1G).....	021
6"-5823 (D6A1F).....	022
8"-5823 (D8A1F).....	022
10"-5823 (D10A1A).....	023
4"-5824 (D4D1B).....	023
5"-5824 (D5D1F).....	024
6"-5824 (D6D1AM).....	024
8"-5824 (D8D1G).....	025
10"-5824 (D10D1W).....	025
6"-5826 (D6F1A).....	026
8"-5826 (D8F1A).....	026

10"-5826 (D10F1A).....	027
2"-5874 (G2A1B).....	027
3"-5874 (G3A1B).....	028
4"-5874 (G4A1A).....	028
5"-5874 (G5A1A).....	029
2"-5876 (G2B1A).....	029
3"-5876 (G3B1A).....	030
4"-5876 (G4B1A).....	030
5"-5876 (G5B1A).....	031
6"-5876 (G6B1A).....	031

#### 1200 RPM

4"-5821 (D4C1A).....	032
5"-5821 (D5C1B).....	032
6"-5821 (D6C1A).....	033
8"-5821 (D8C1A).....	033
8"-5821 (D8C1C).....	034
10"-5821 (D10C1A).....	034
12"-5821 (D12C1B).....	035
14"-5821 (D14C1A).....	035
4"-5822 (D4B1C).....	036
5"-5822 (D5B1K).....	036
6"-5822 (D6B1F).....	037
8"-5822 (D8B1R).....	037
12"-5822 (D12B1A).....	038
4"-5823 (D4A1C).....	038
5"-5823 (D5A1G).....	039
6"-5823 (D6A1F).....	039
8"-5823 (D8A1F).....	040
10"-5823 (D10A1A).....	040
12"-5823 (D12A1A).....	041
16"-5823 (M16A1C).....	041
16"-5823 (M16A1L).....	042
18"-5823 (D18A1B).....	042
4"-5824 (D4D1B).....	043
5"-5824 (D5D1F).....	043
6"-5824 (D6D1AM).....	045
8"-5824 (D8D1G).....	045
10"-5824 (D10D1W).....	046
10"-5825 (D10E1A).....	046
6"-5826 (D6F1A).....	047
8"-5826 (D8F1A).....	047

10"-5826 (D10F1A) .....	048
20"-5822A (D20L1A) .....	049
20"-5826A (D20H1A).....	049

**900 RPM**

10"-5821 (D10C1A).....	051
12"-5821 (D12C1B).....	051
14"-5821 (D14C1A).....	052
20"-5821 (D20C1A).....	052
12"-5822 (D12B1A).....	053
20"-5822 (D20B1A).....	053
12"-5823 (D12A1A).....	054
16"-5823 (M16A1A).....	054
16"-5823 (M16A1C).....	055
16"-5823 (M16A1L).....	055
20"-5823 (D20A1A).....	056
18"-5823 (D18A1B).....	056
20"-5824 (D20D1A).....	057
10"-5825 (D10E1A).....	057
24"-5823A (D24L1A).....	059
20"-5825A (D20M1A).....	059
24"-5826A (D24H1A).....	060
30"-5826A (D30H1A).....	060

**720 RPM**

20"-5821 (D20C1A).....	061
20"-5822 (D20B1A).....	061
16"-5823 (M16A1A).....	062
16"-5823 (M16A1C).....	062
30"-5822A (D30L1A).....	063
24"-5825A (D24M1A).....	063
20"-5823 (D20A1A).....	065
20"-5824 (D20D1A).....	065

**600 RPM**

20"-5821 (D20C1A).....	066
20"-5822 (D20B1A).....	066
24"-5822 (D24B1A).....	067
16"-5823 (M16A1A).....	067
20"-5823 (D20A1A).....	068
30"-5823 (D30A1A).....	068
30"-5825A (D30M1A).....	069
20"-5824 (D20D1A).....	071
36"-5824 (D36D1A).....	071

**514 RPM**

24"-5822 (D24B1A).....	072
30"-5823 (D30A1A).....	072
36"-5824 (D36D1A).....	073

**450 RPM**

24"-5822 (D24B1A).....	074
30"-5823 (D30A1A).....	074
36"-5824 (D36D1A).....	075

**400 RPM**

36"-5821 (D36C1A).....	076
------------------------	-----

**360 RPM**

36"-5821 (D36C1A).....	076
------------------------	-----

**326 RPM**

36"-5821 (D36C1A).....	077
------------------------	-----

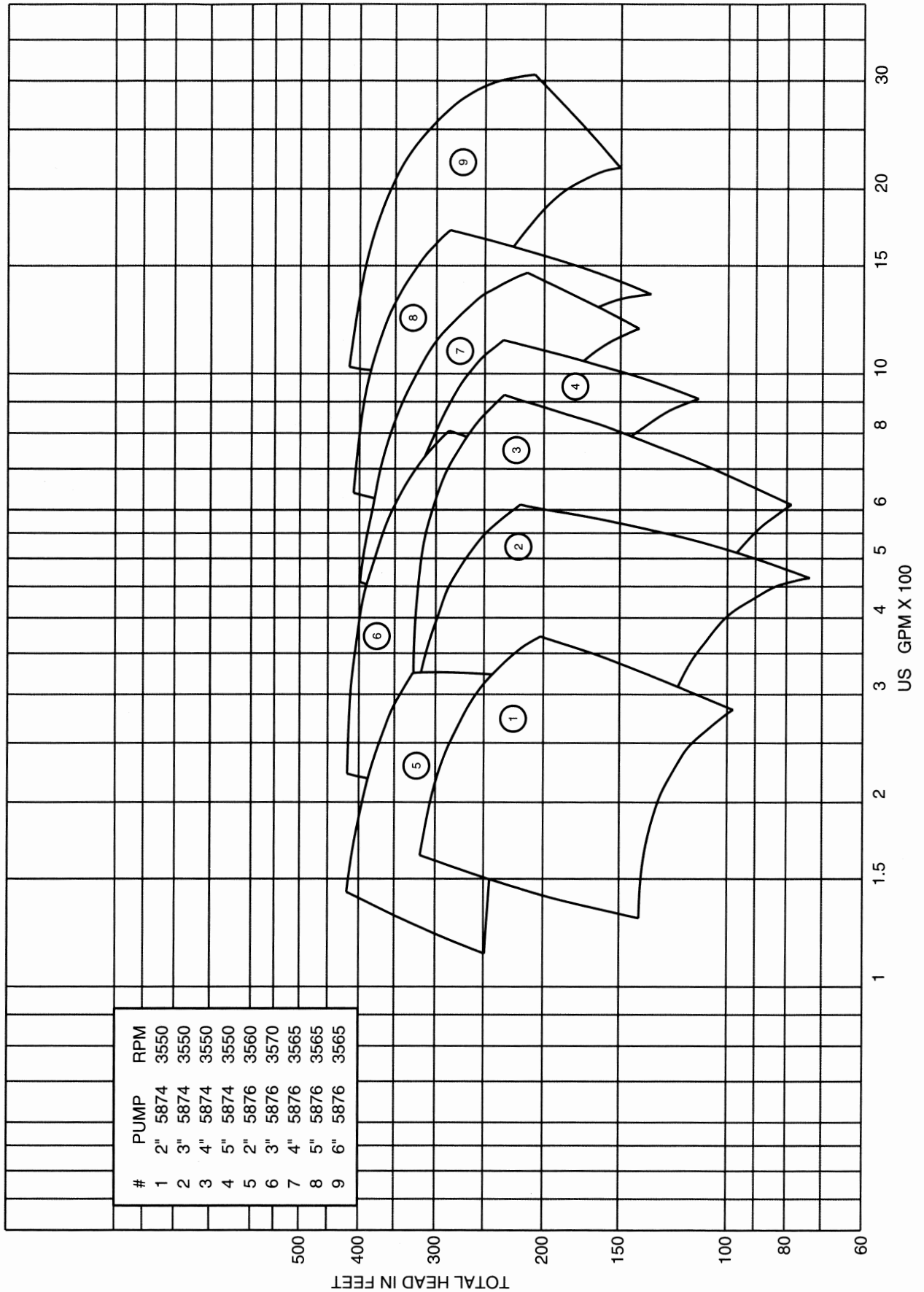

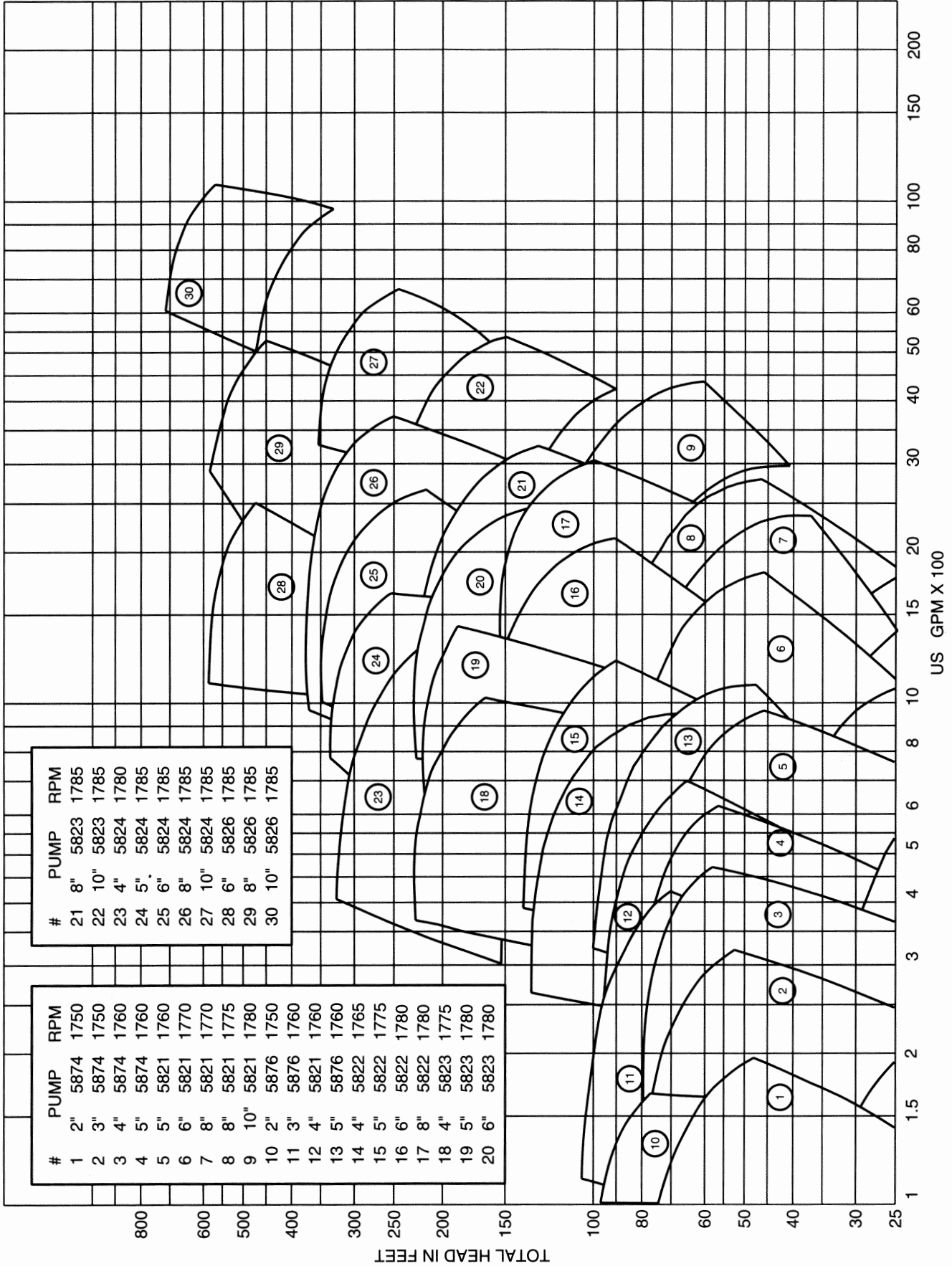



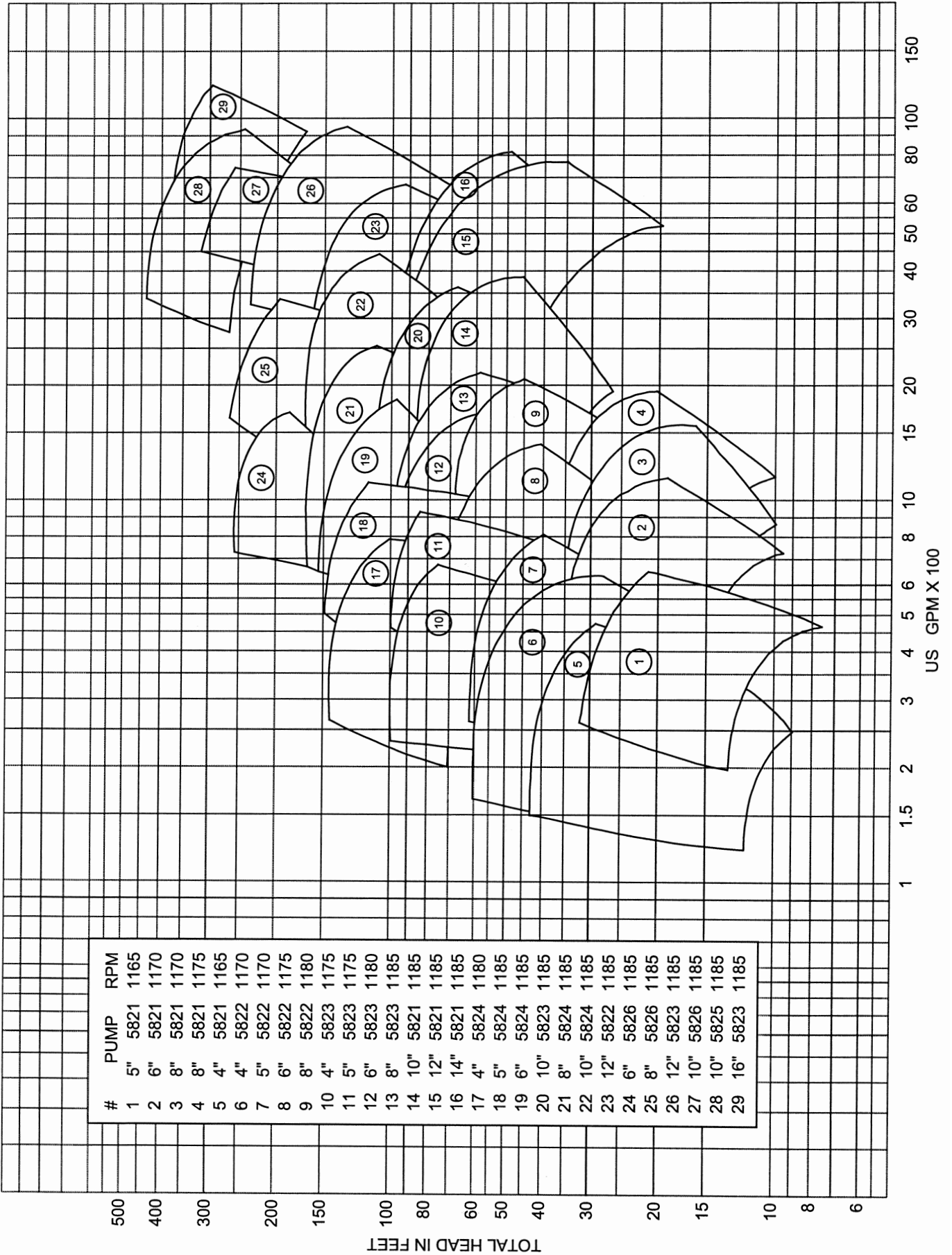

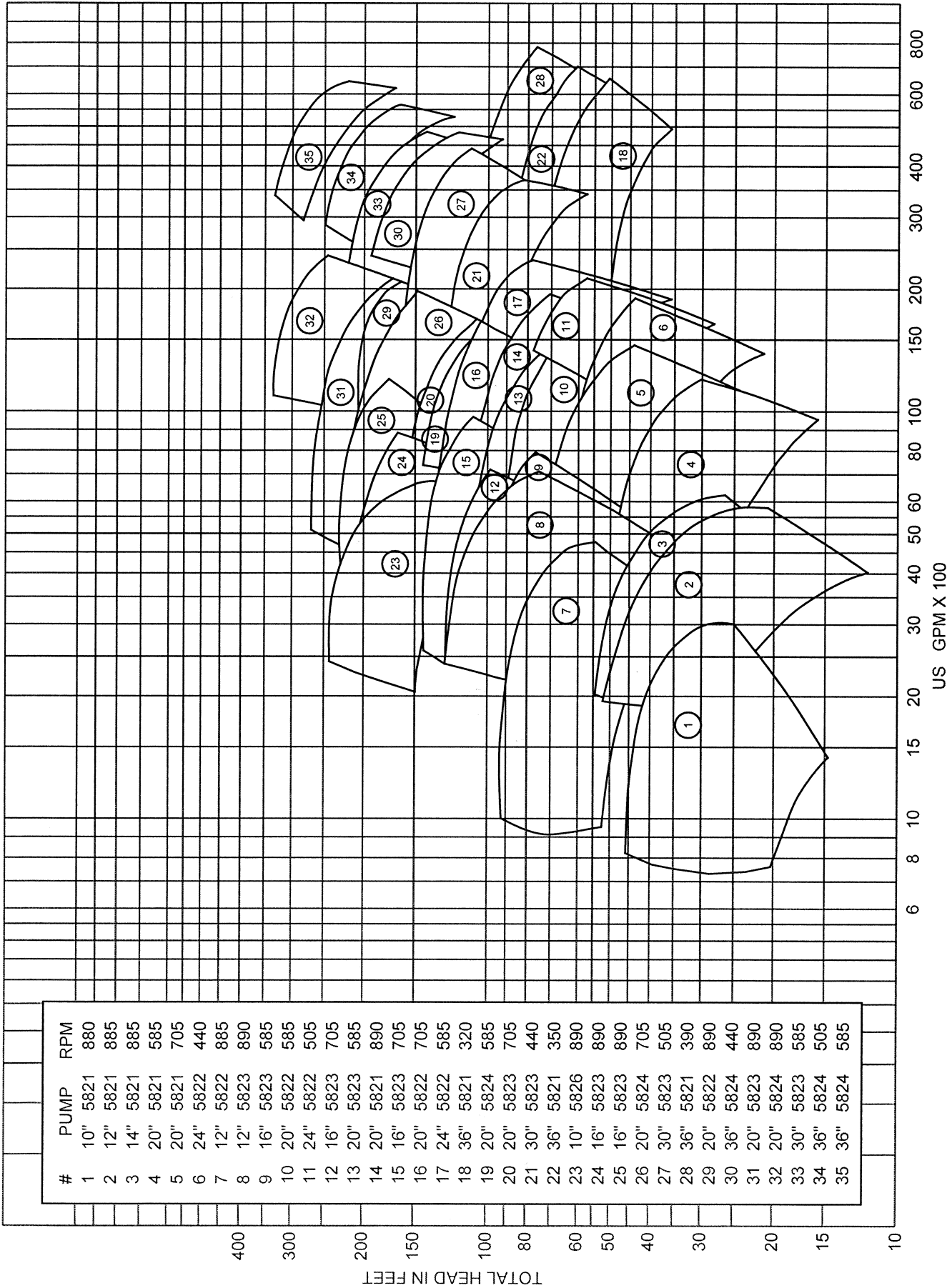

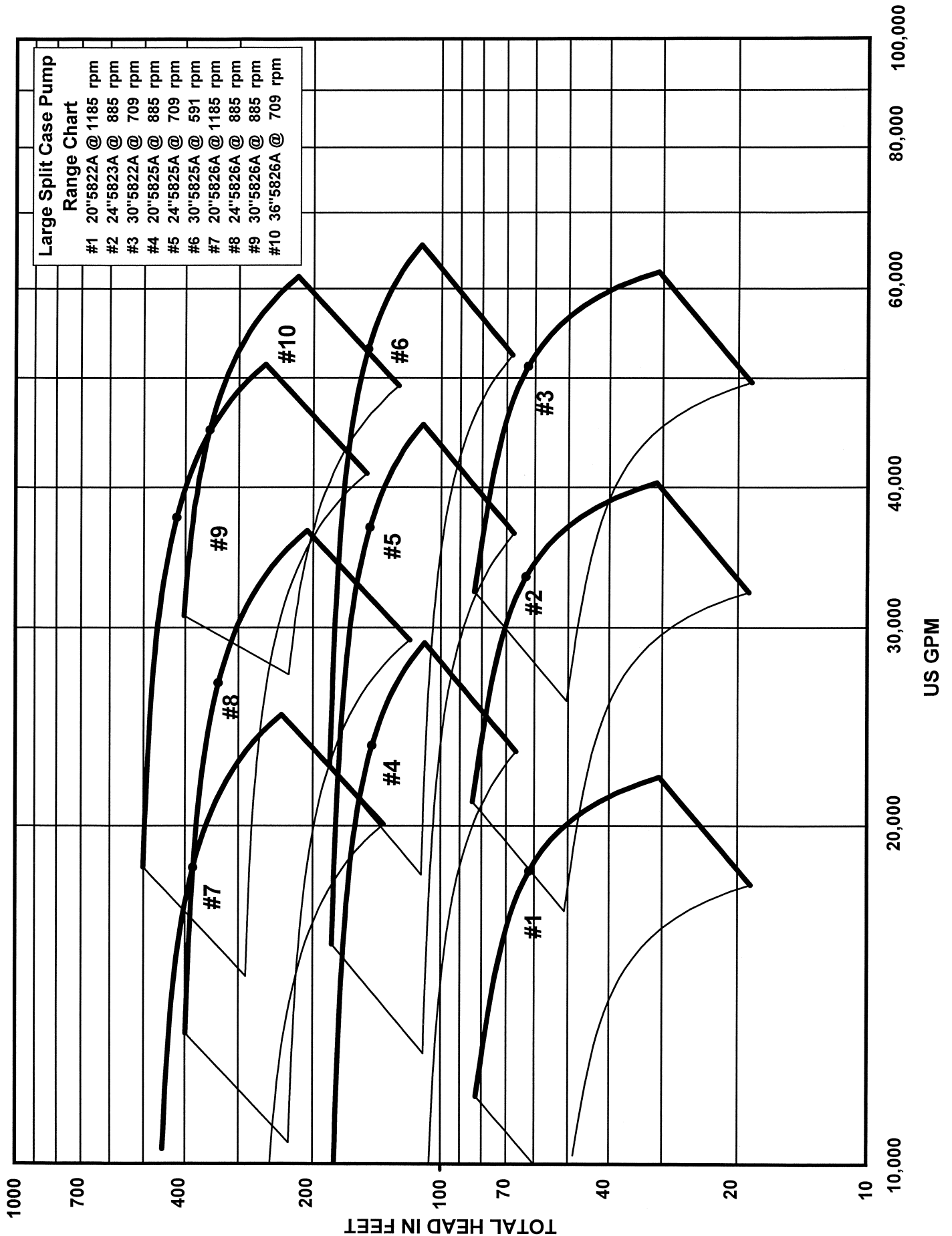

 Notes:



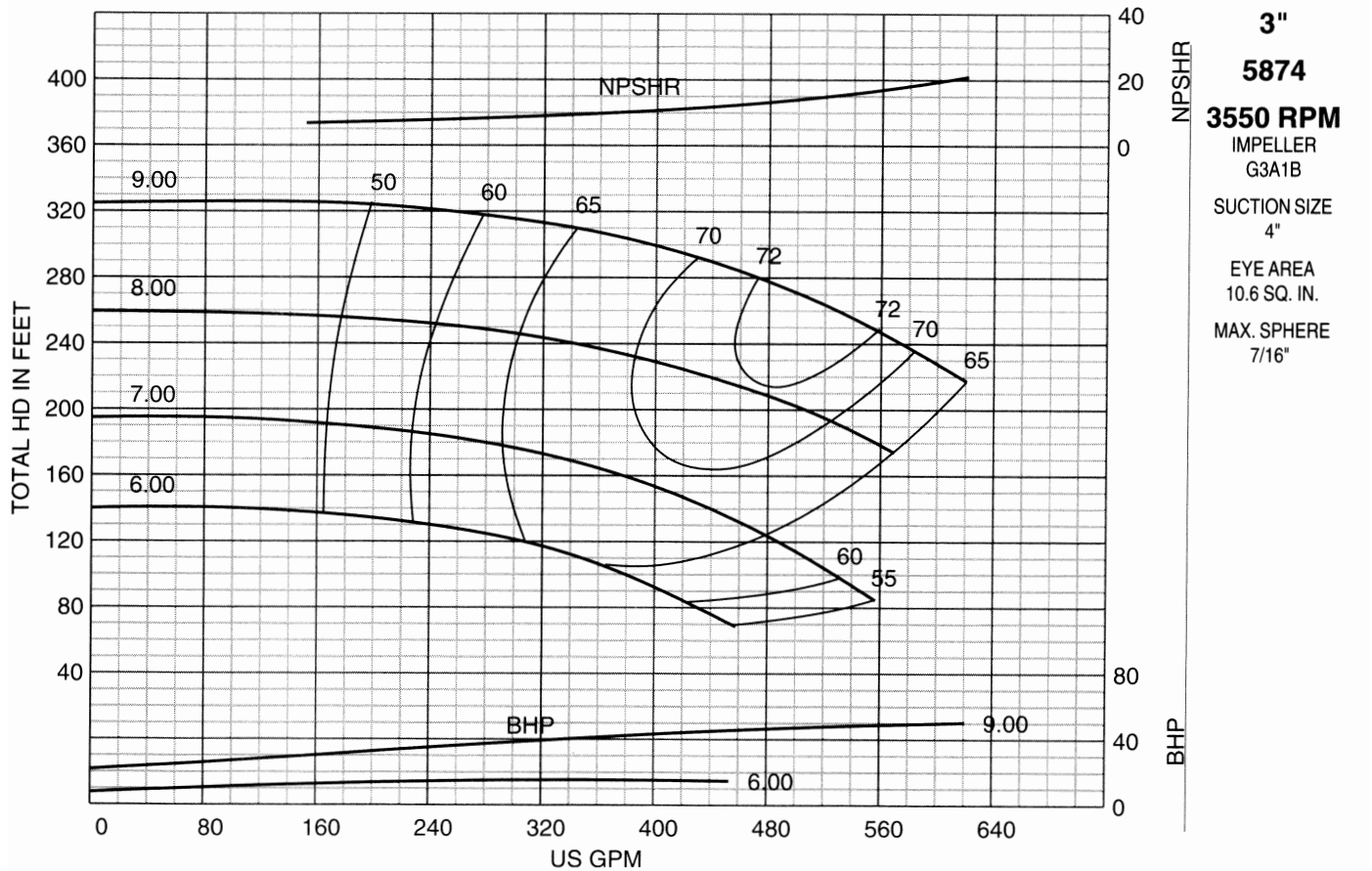
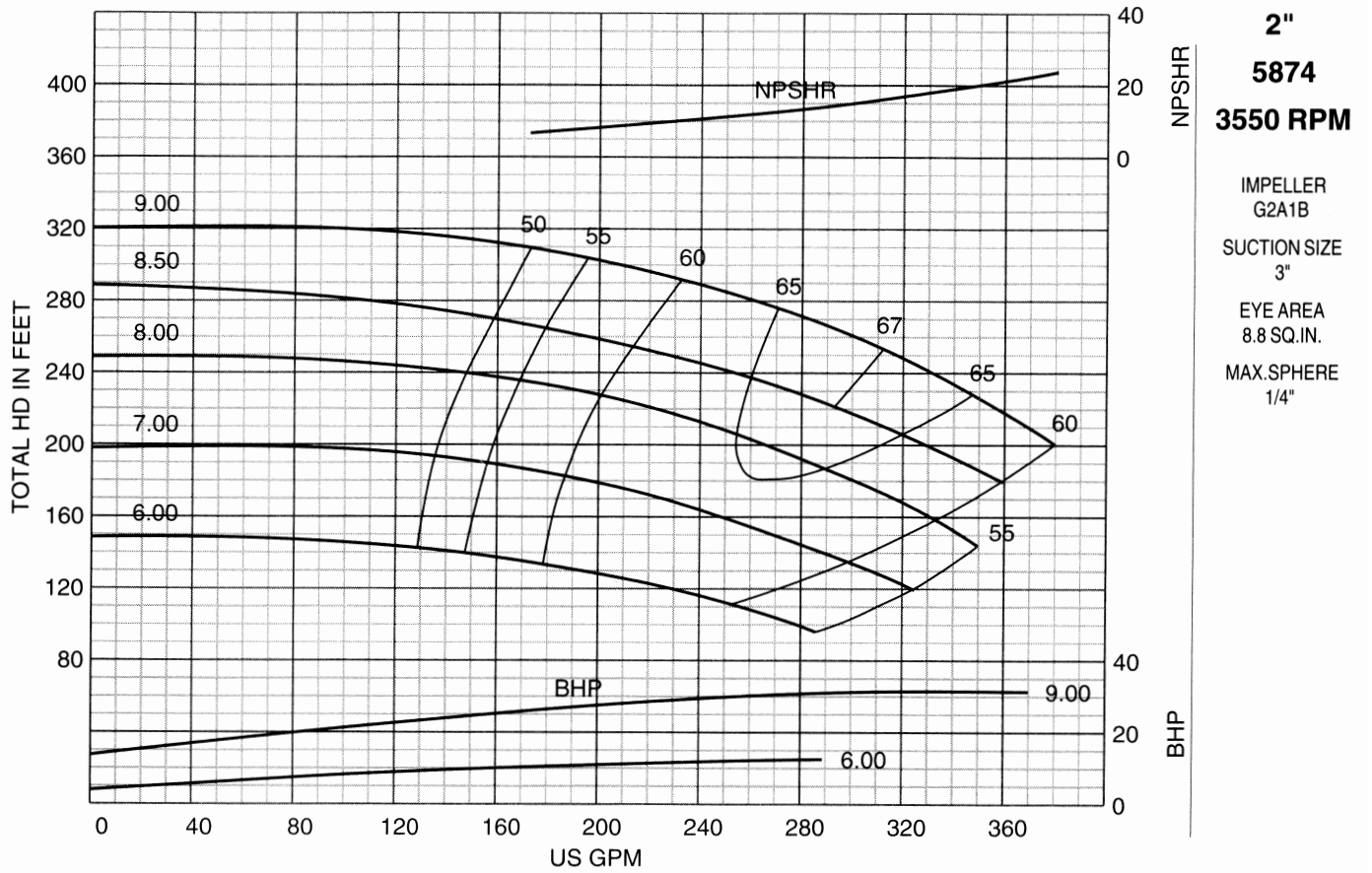



**4"**  
**5874**  
**3550 RPM**  
 IMPELLER  
 G4A1A  
 SUCTION SIZE  
 5"  
 EYE AREA  
 16.6 SQ. IN.  
 MAX.SPHERE  
 .5"

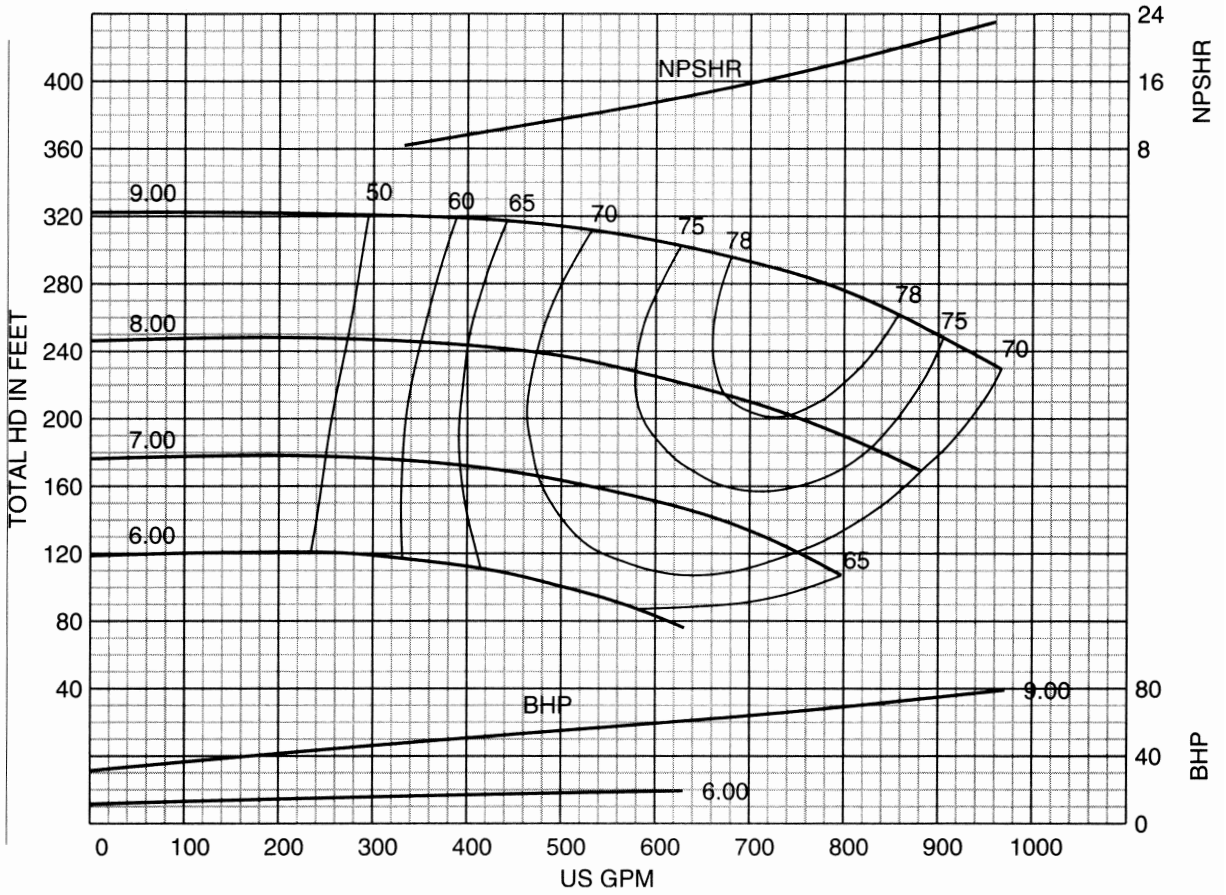

**5"**  
**5874**  
**3550 RPM**  
 IMPELLER  
 G5A1A  
 SUCTION SIZE  
 6"  
 EYE AREA  
 24.2 SQ. IN.  
 MAX.SPHERE  
 .5625"

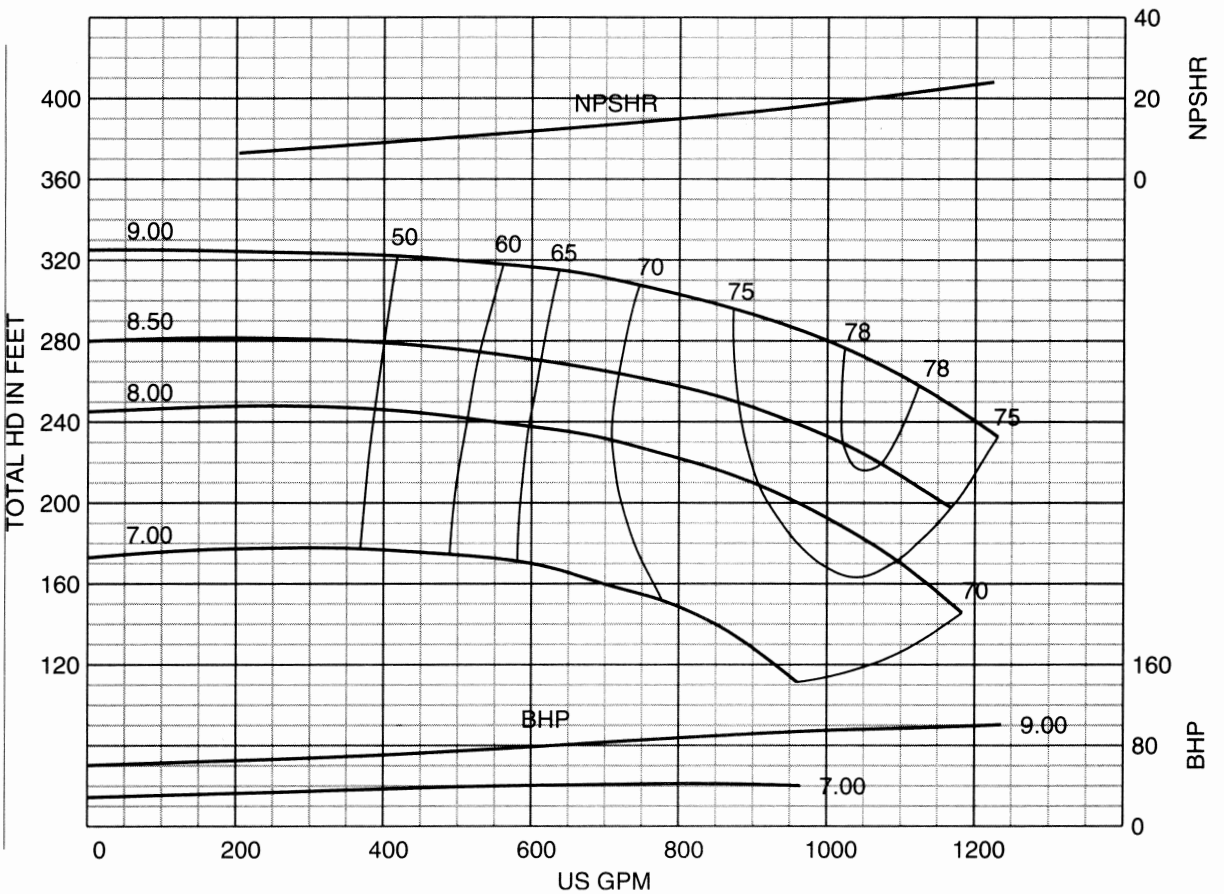

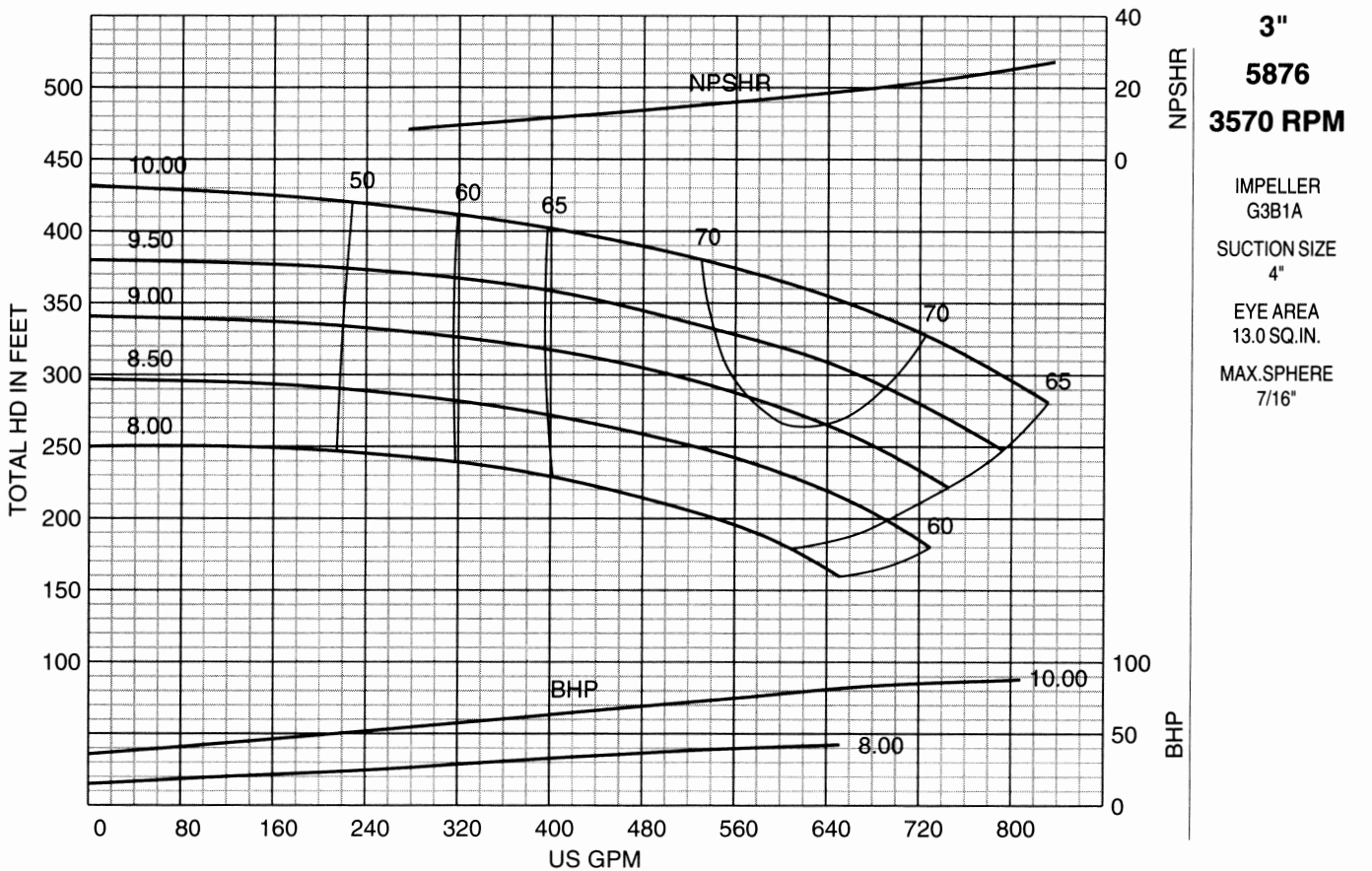
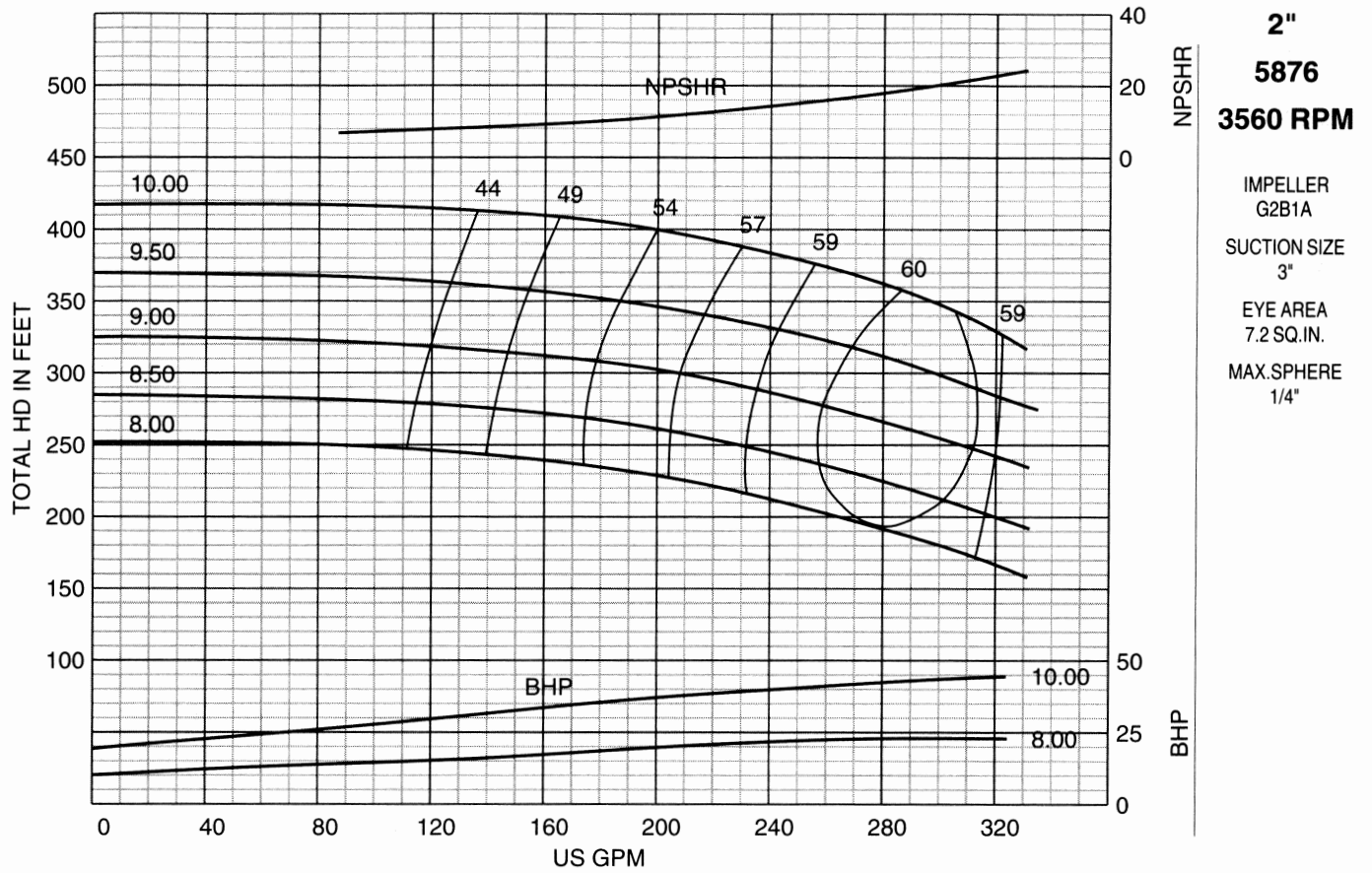



**4"**  
**5876**  
**3565 RPM**  
 IMPELLER  
 G4B1A  
 SUCTION SIZE  
 6"  
 EYE AREA  
 21.9 SQ. IN.  
 MAX.SPHERE  
 .5

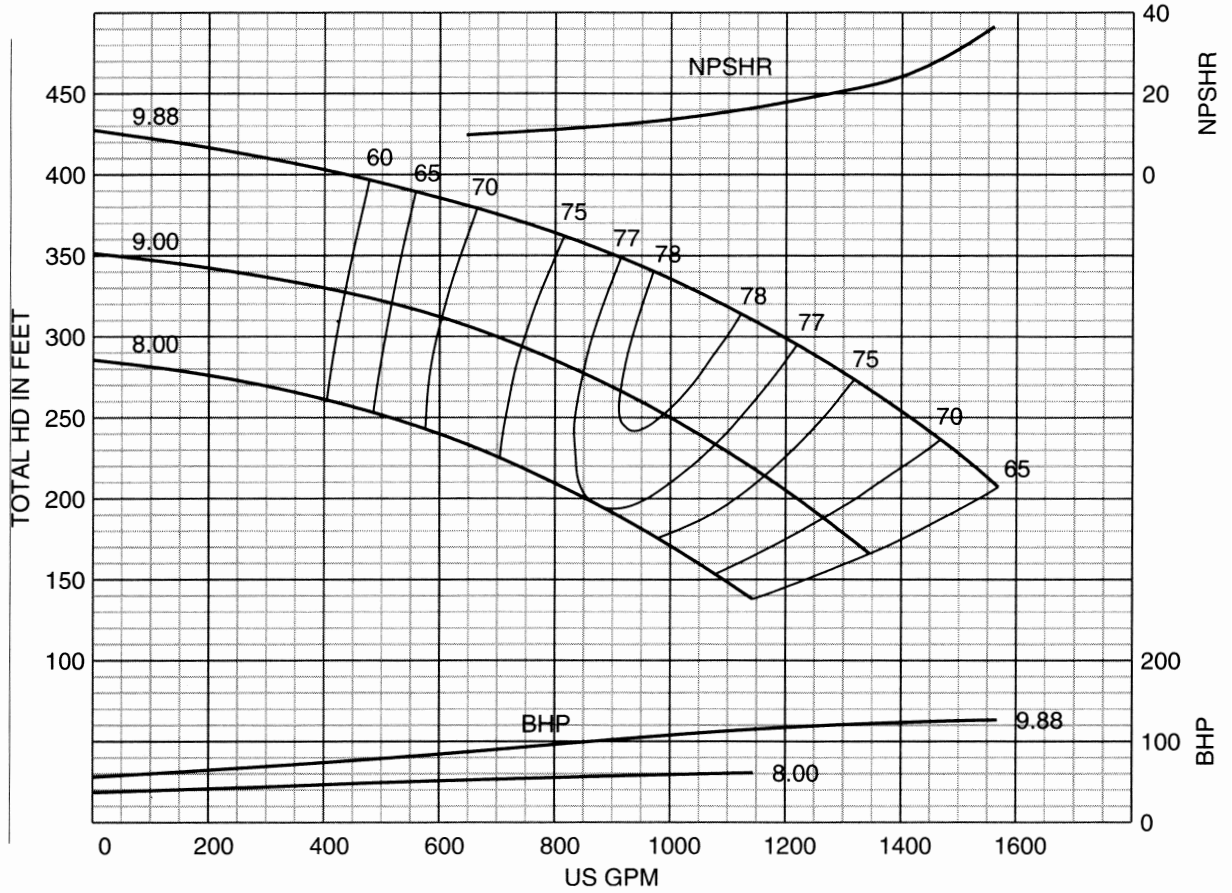

**5"**  
**5876**  
**3565 RPM**  
 IMPELLER  
 G5B1A  
 SUCTION SIZE  
 8"  
 EYE AREA  
 24.7 SQ. IN.  
 MAX.SPHERE  
 .625"

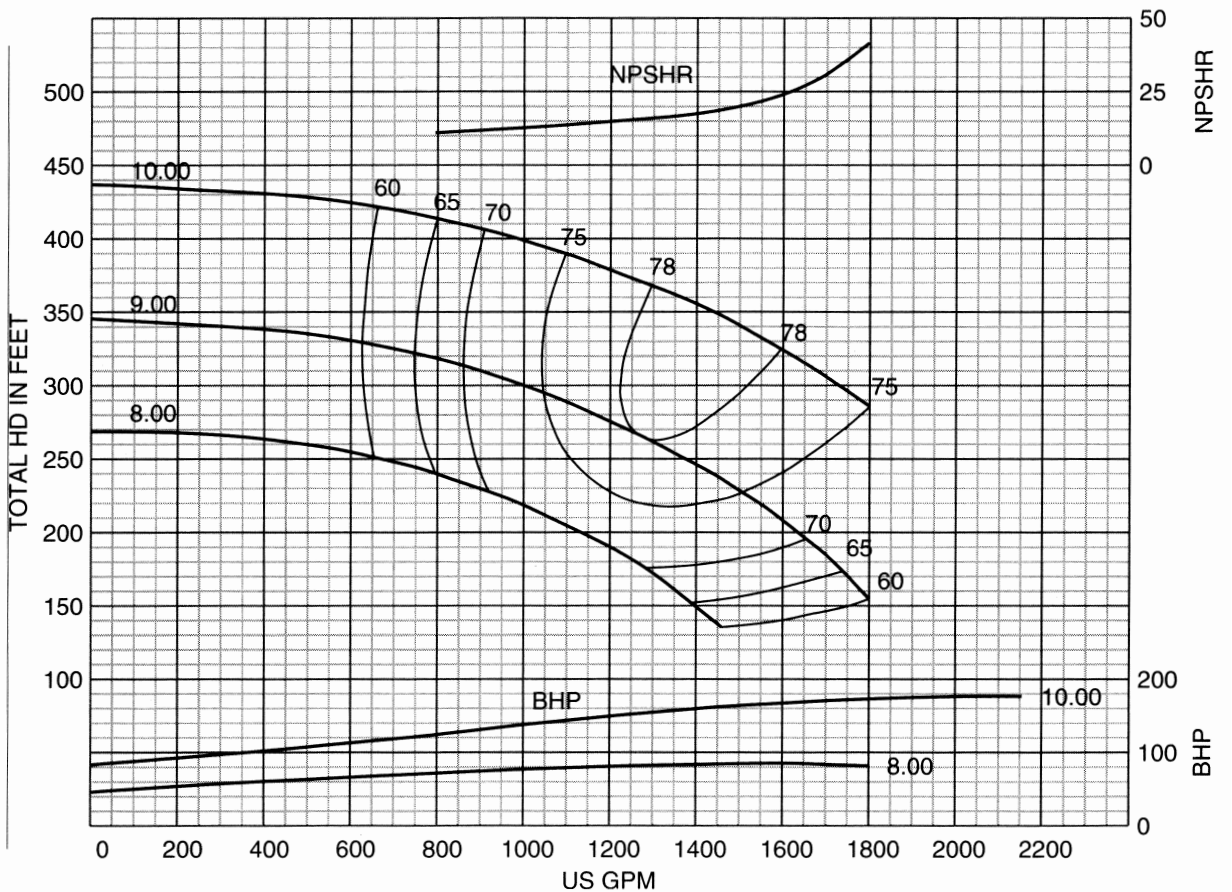

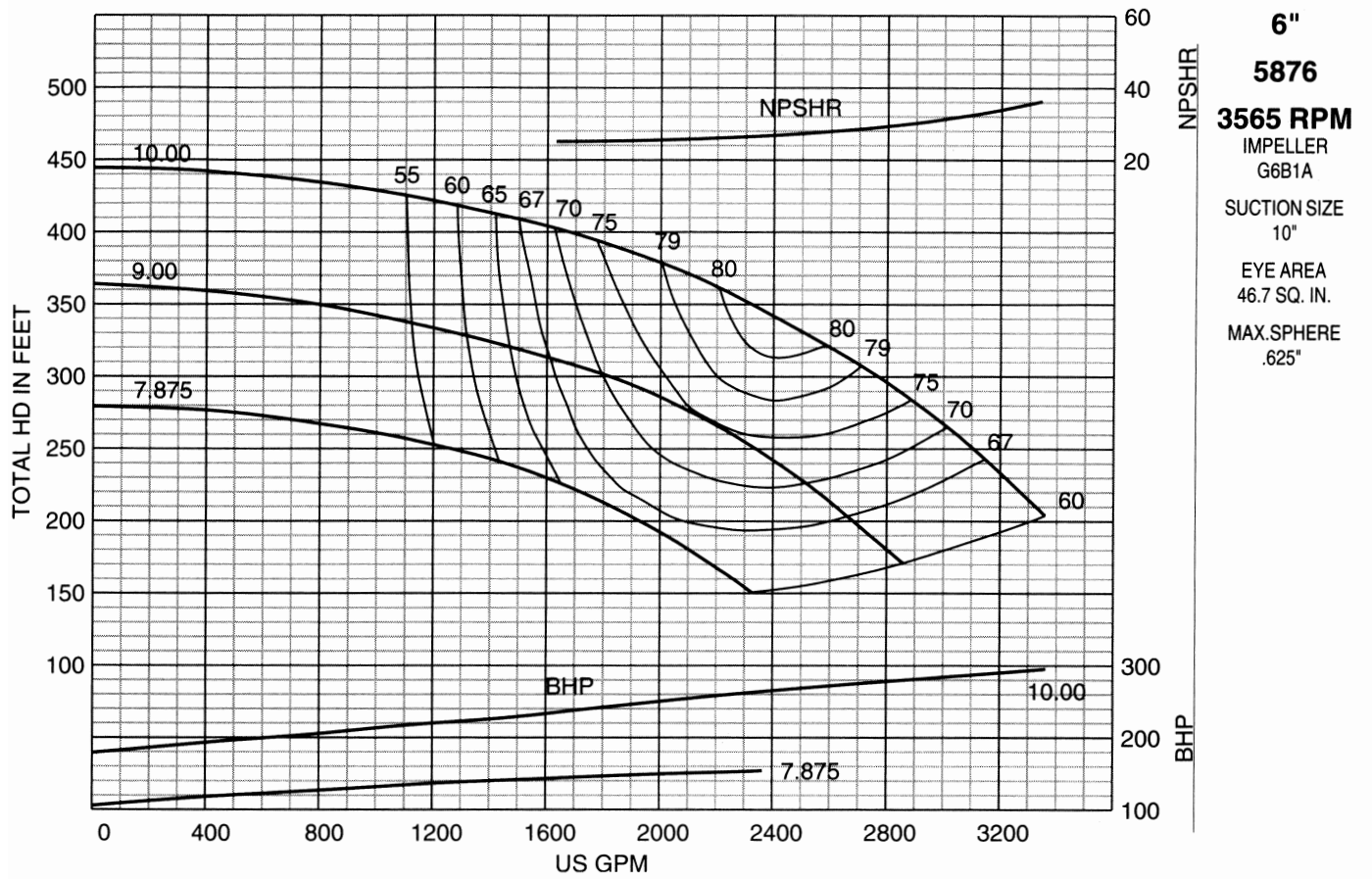



**4"**  
**5821**  
**1760 RPM**

IMPELLER  
D4C1A  
SUCTION SIZE  
5"  
EYE AREA  
20.0 SQ. IN.  
MAX. SPHERE  
5/8"

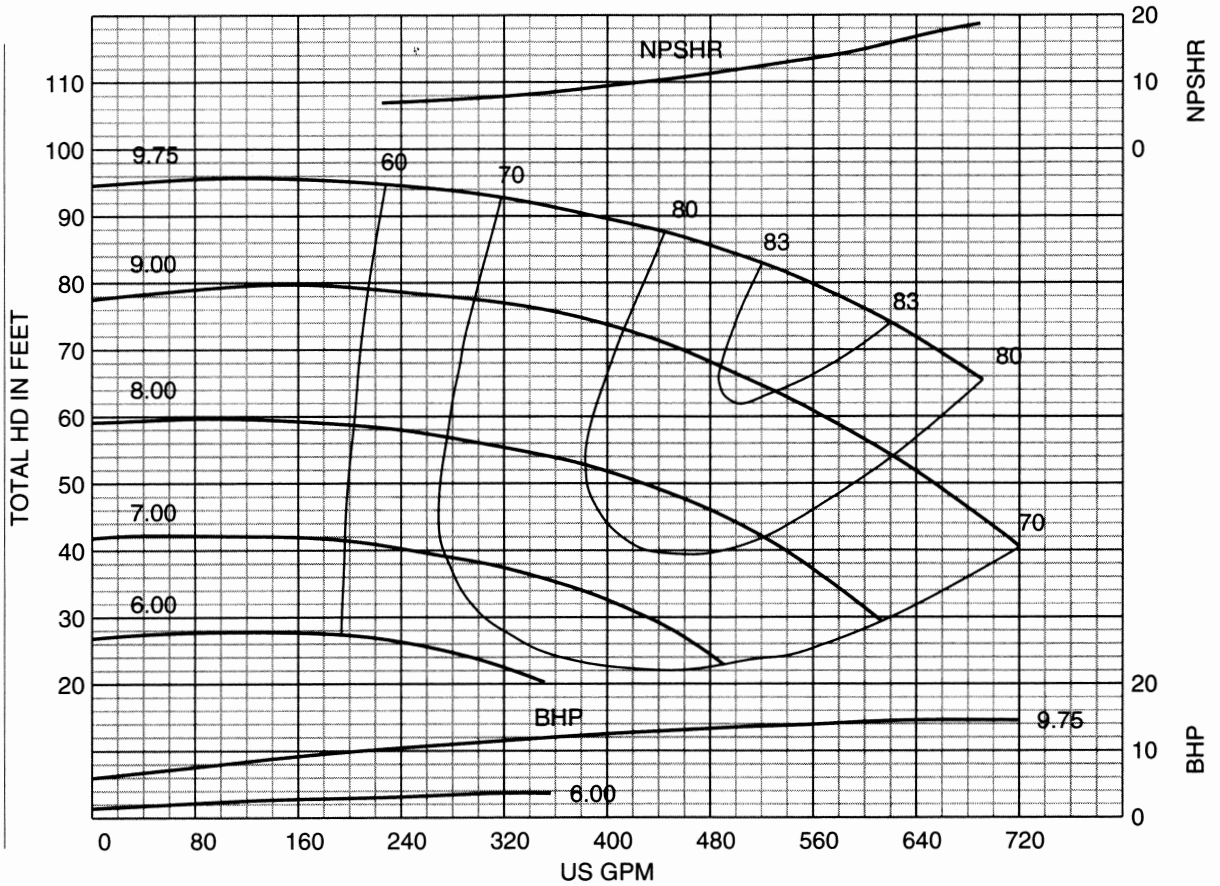

**5"**  
**5821**  
**1760 RPM**

IMPELLER  
D5C1B  
SUCTION SIZE  
6"  
EYE AREA  
25.0 SQ. IN.  
MAX. SPHERE  
3/4"

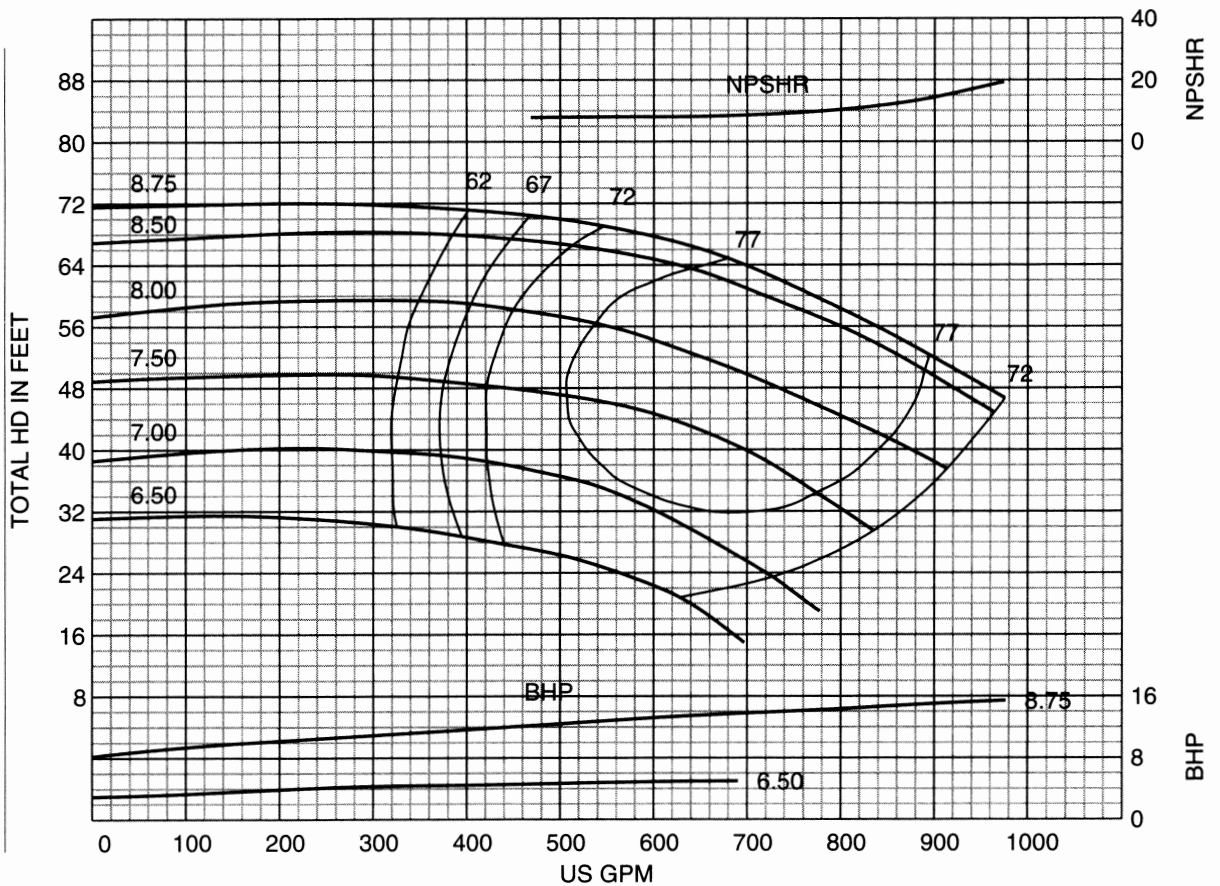



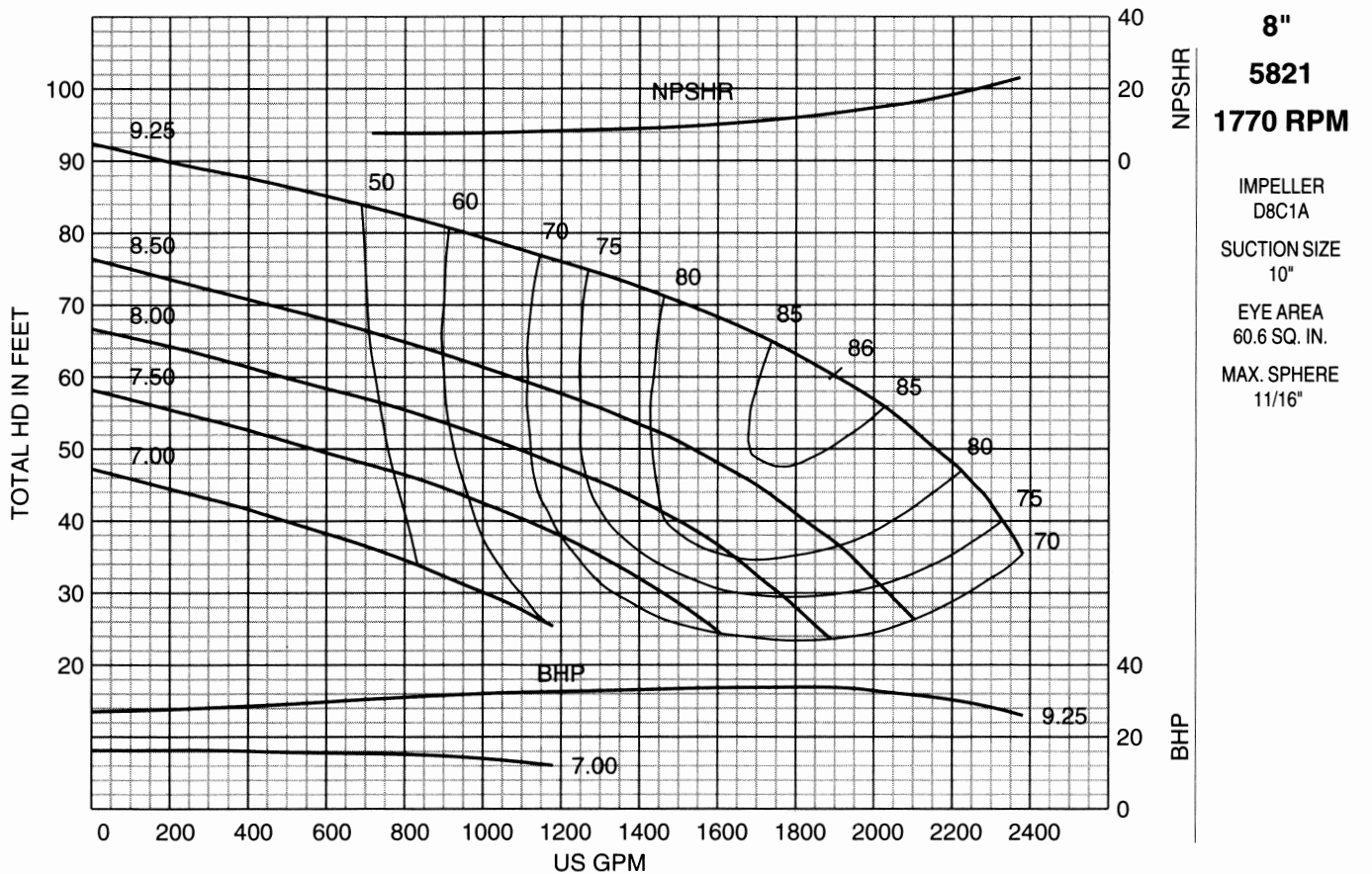
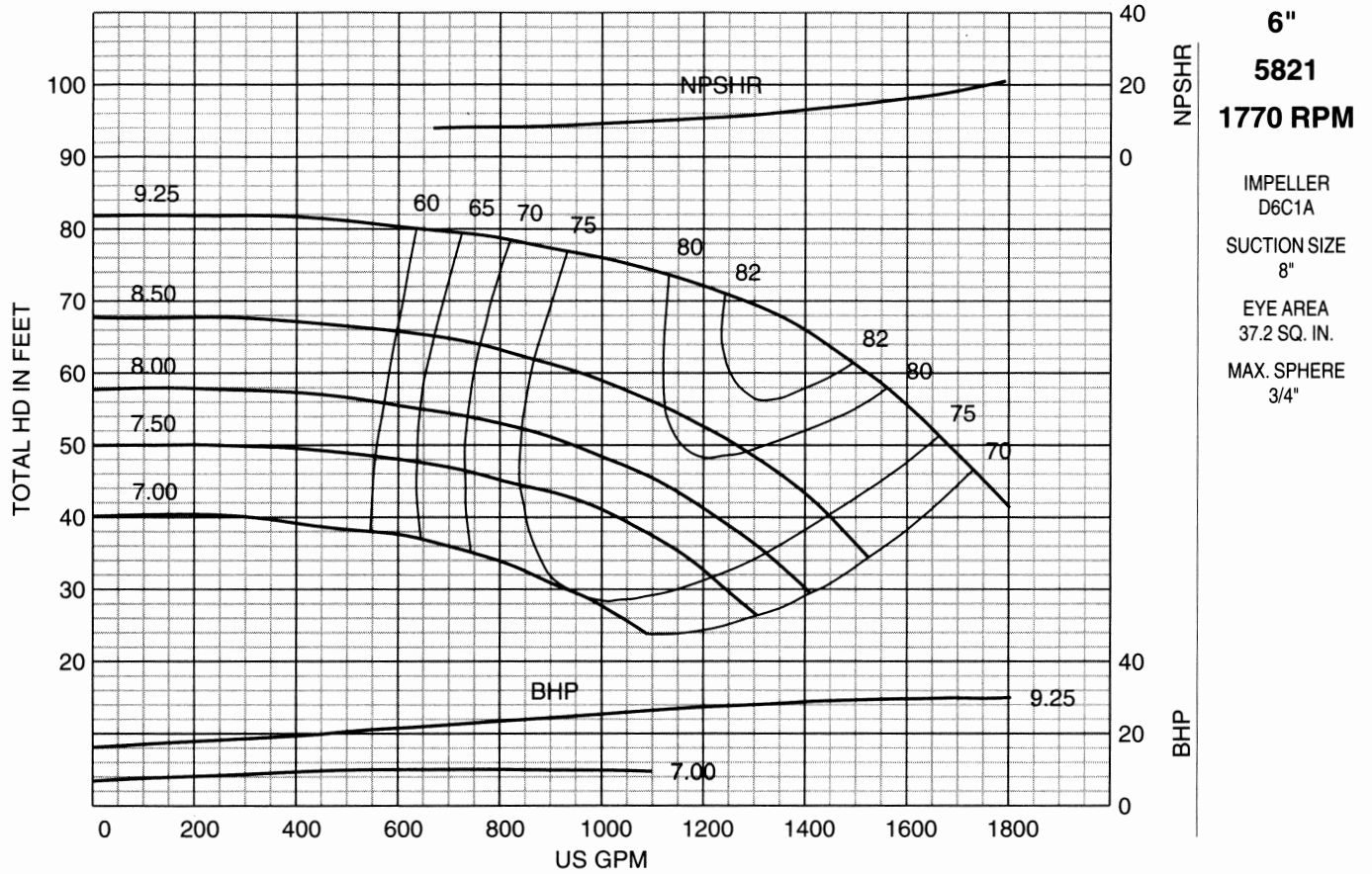

**8"**  
**5821**  
**1775 RPM**

IMPELLER  
D8C1C  
SUCTION SIZE  
10"  
EYE AREA  
64.6 SQ. IN.  
MAX. SPHERE  
11/16"

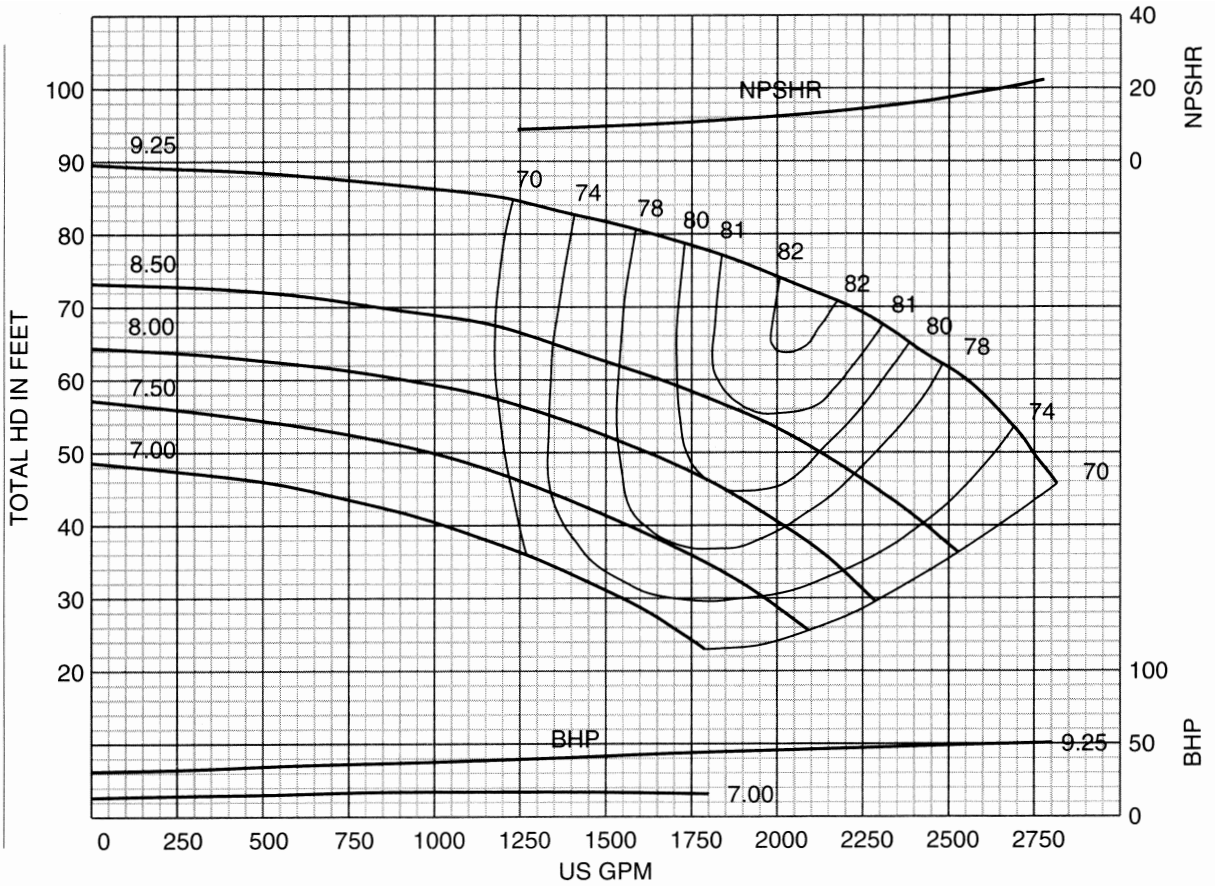

**10"**  
**5821**  
**1780 RPM**

IMPELLER  
D10C1E  
SUCTION SIZE  
12"  
EYE AREA  
75.6 SQ. IN.  
MAX. SPHERE  
1 1/8"

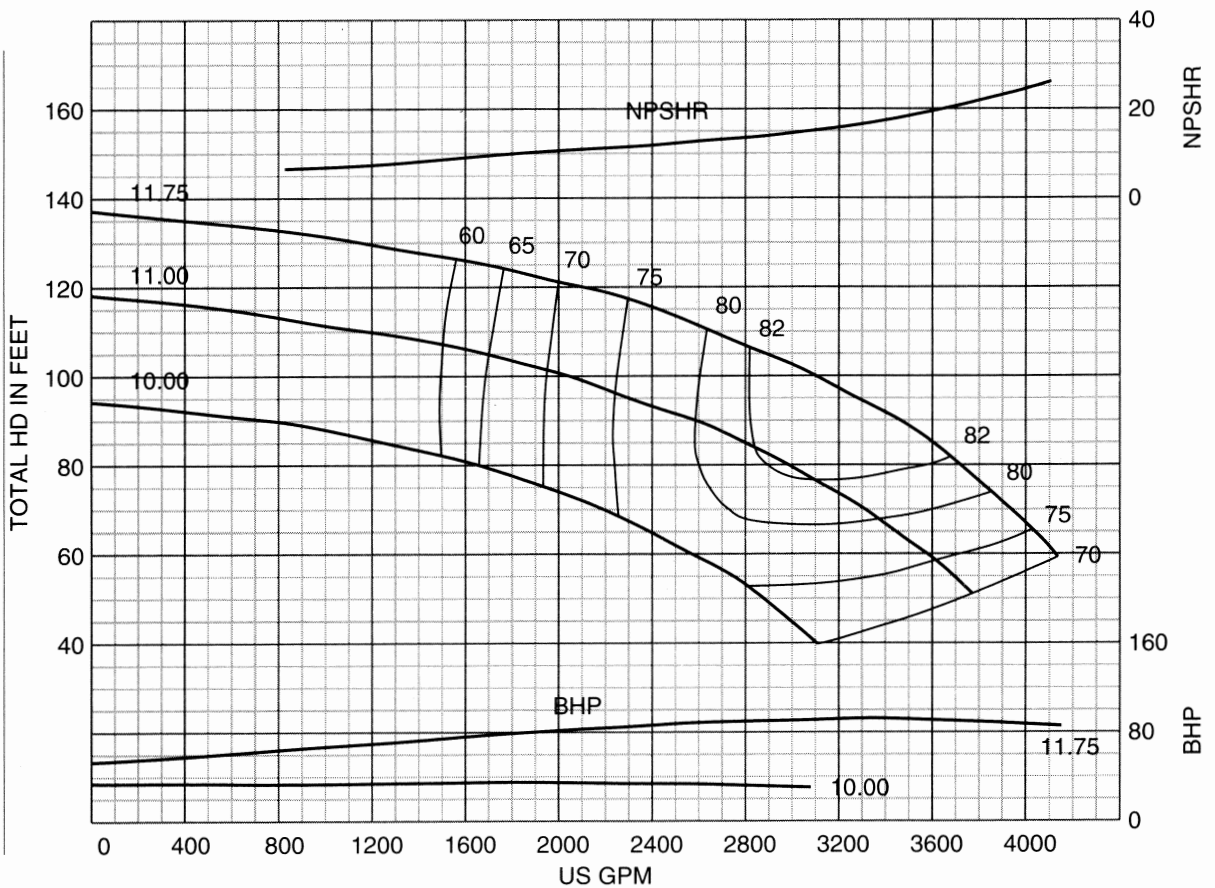



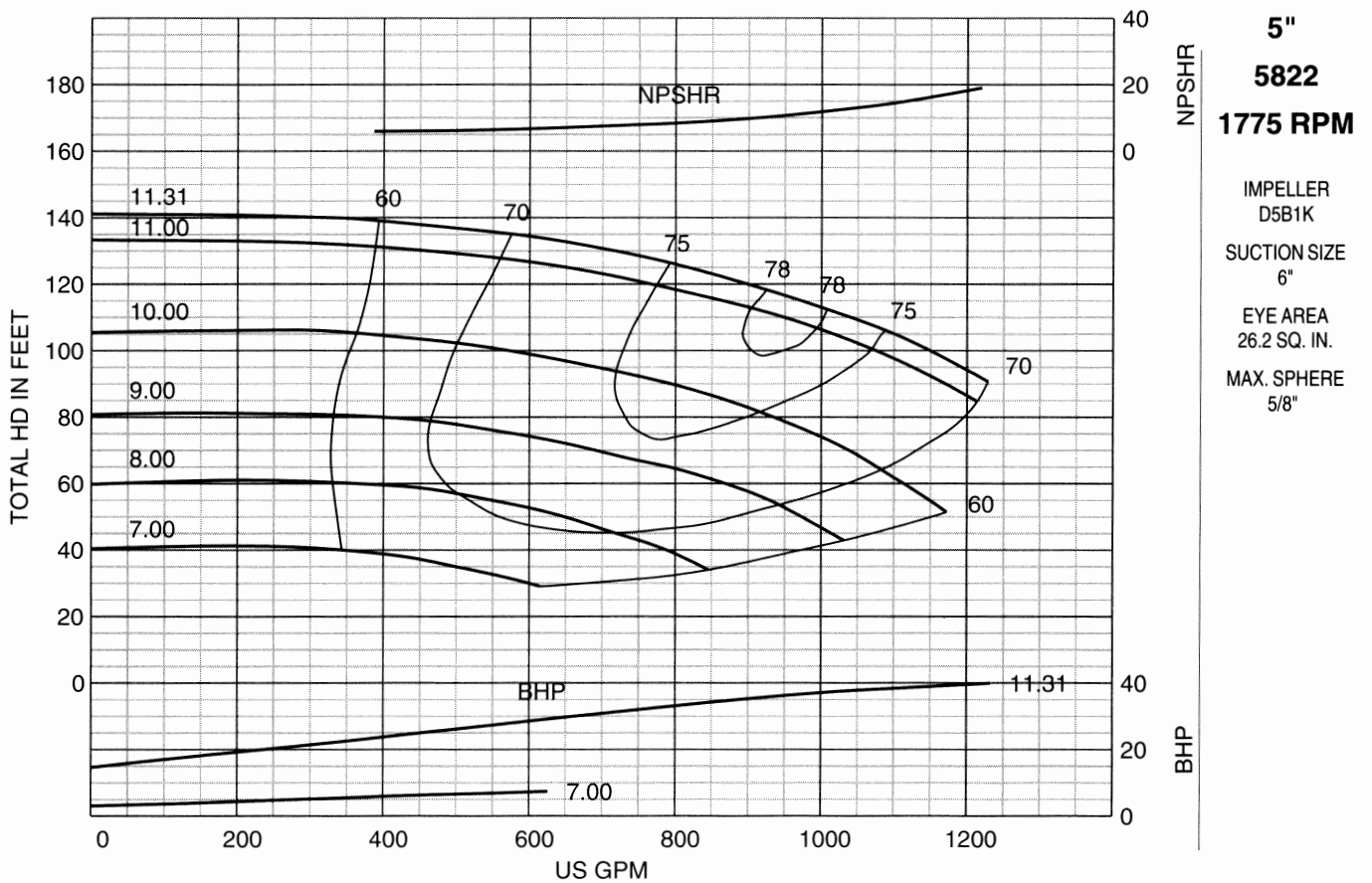
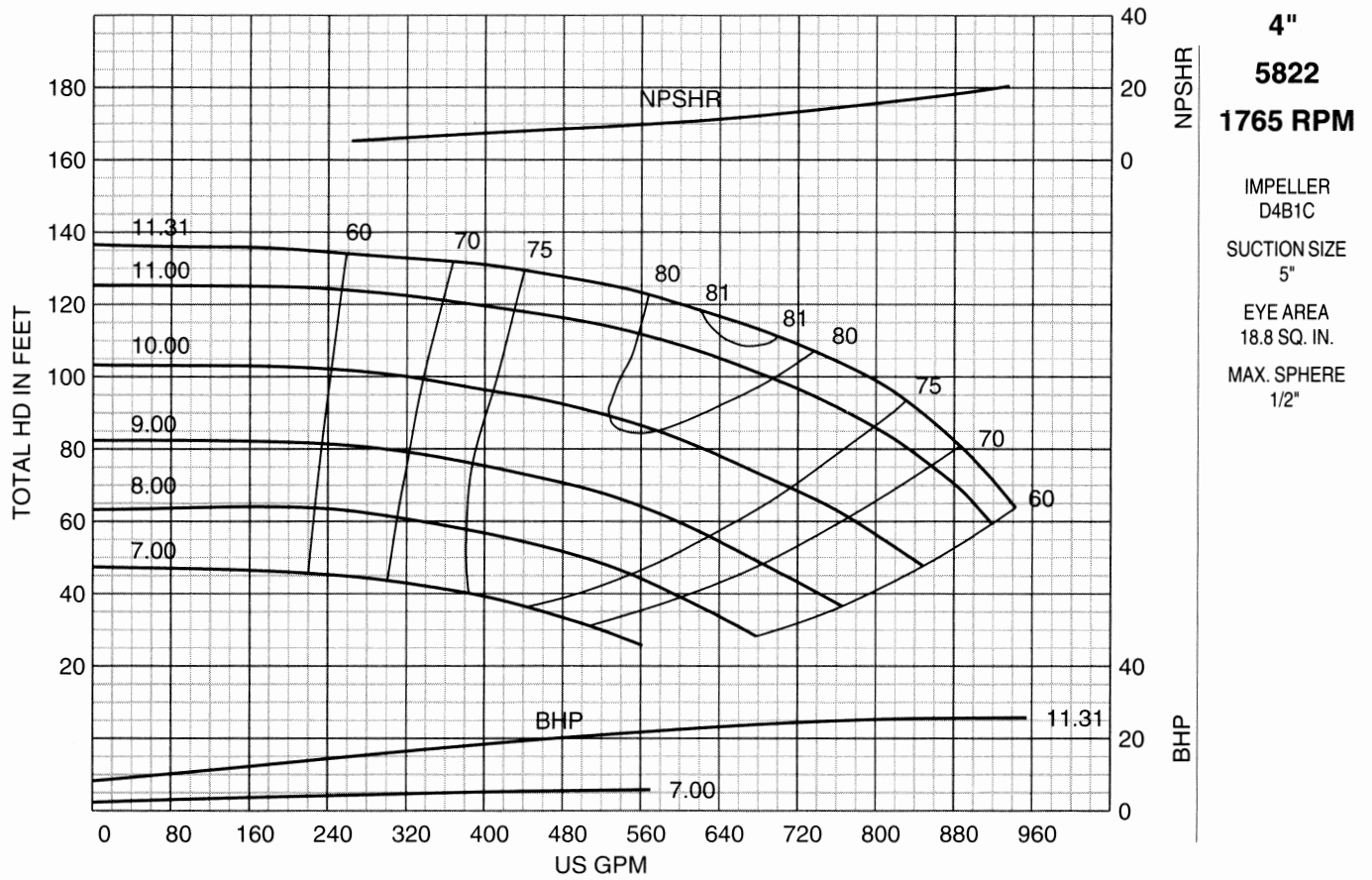

**6"**  
**5822**  
**1780 RPM**

IMPELLER  
D6B1F  
SUCTION SIZE  
8"  
EYE AREA  
33.6 SQ. IN.  
MAX. SPHERE  
13/16"

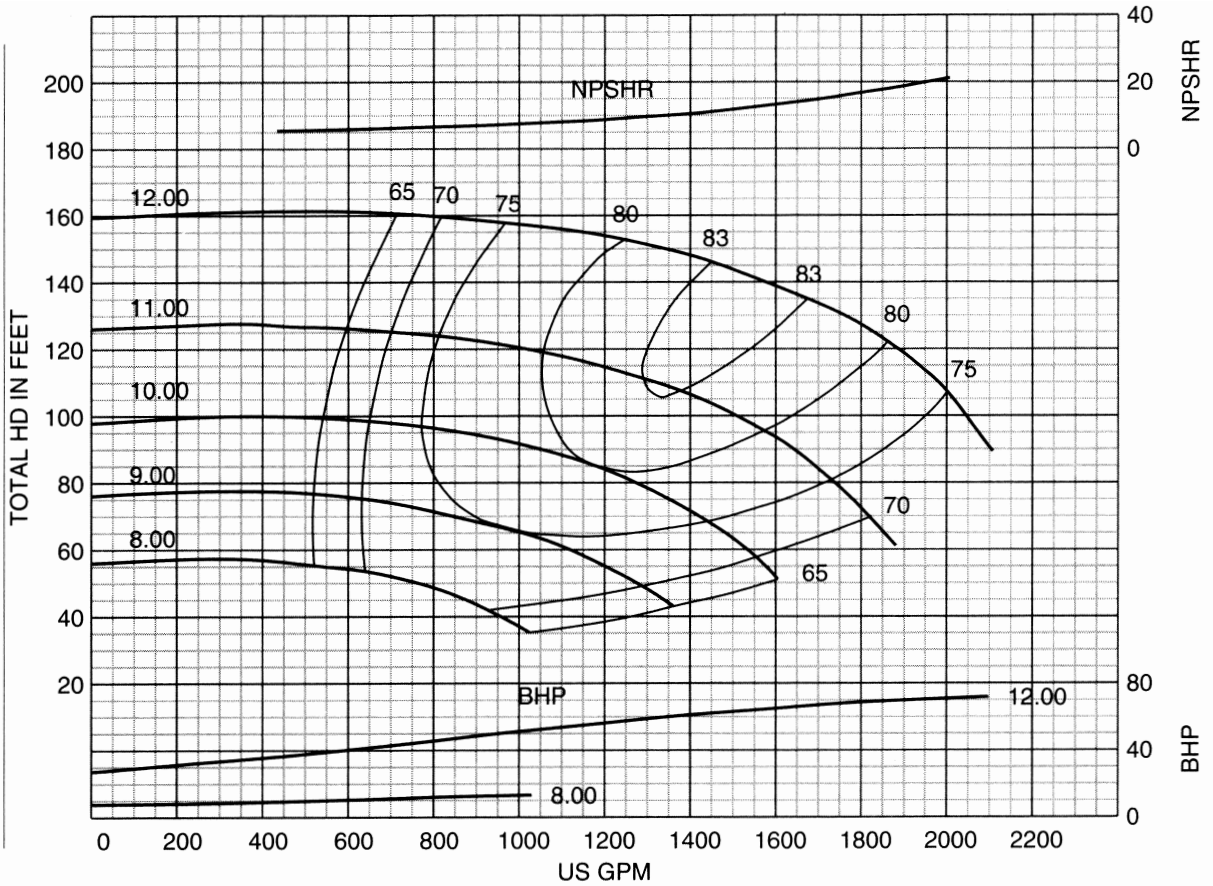

**8"**  
**5822**  
**1780 RPM**

IMPELLER  
D8B1R  
SUCTION SIZE  
10"  
EYE AREA  
59.1 SQ. IN.  
MAX. SPHERE  
15/16"

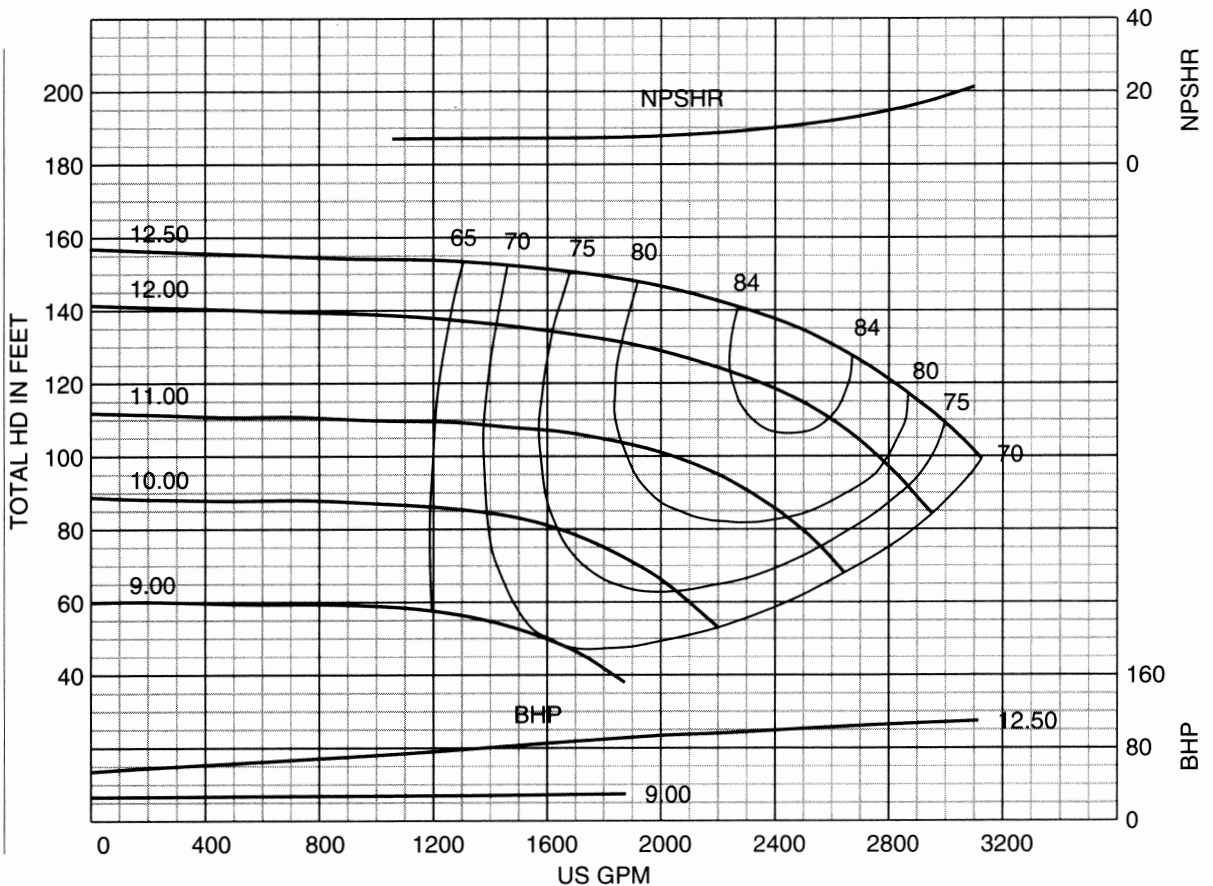



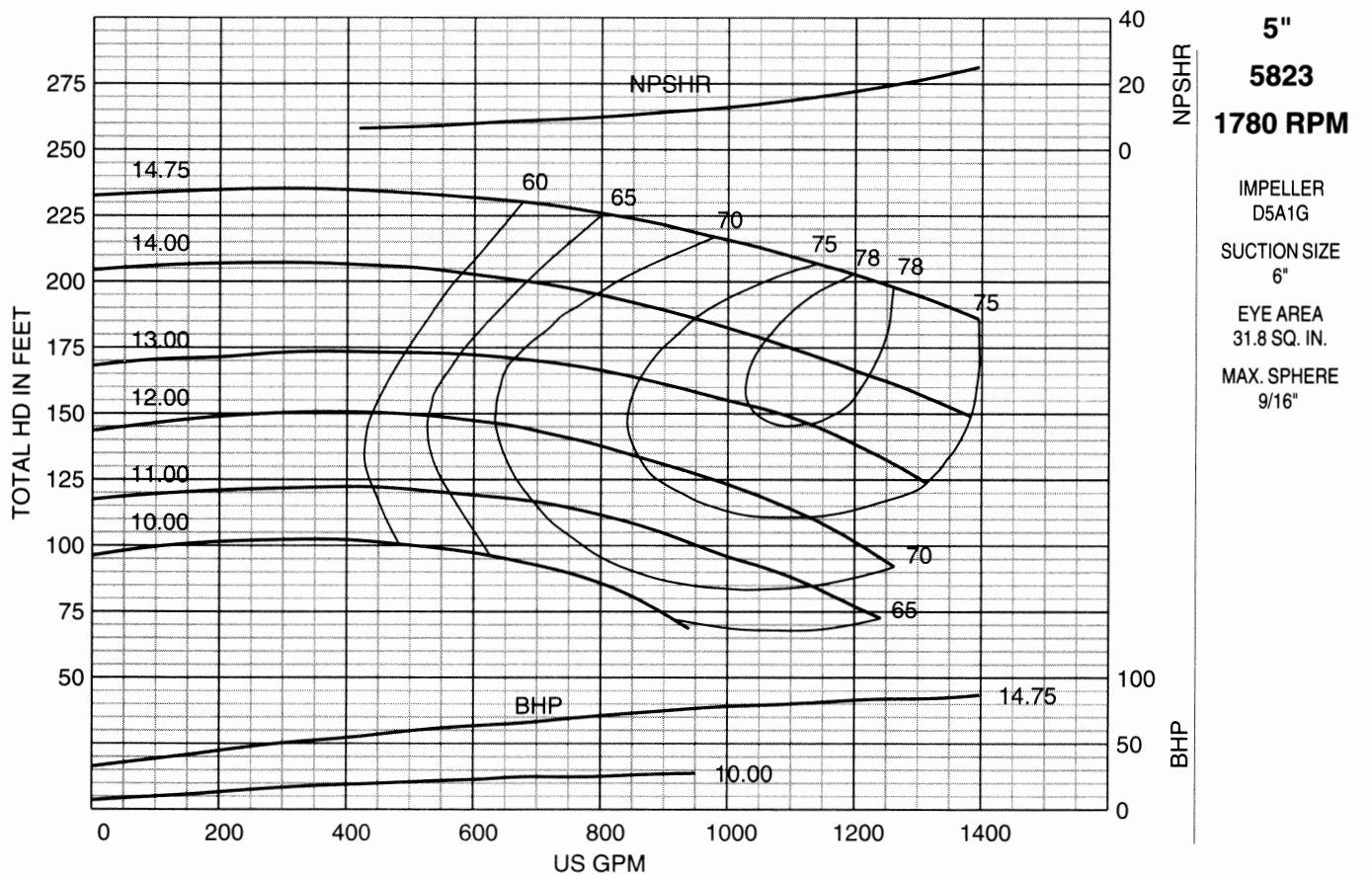
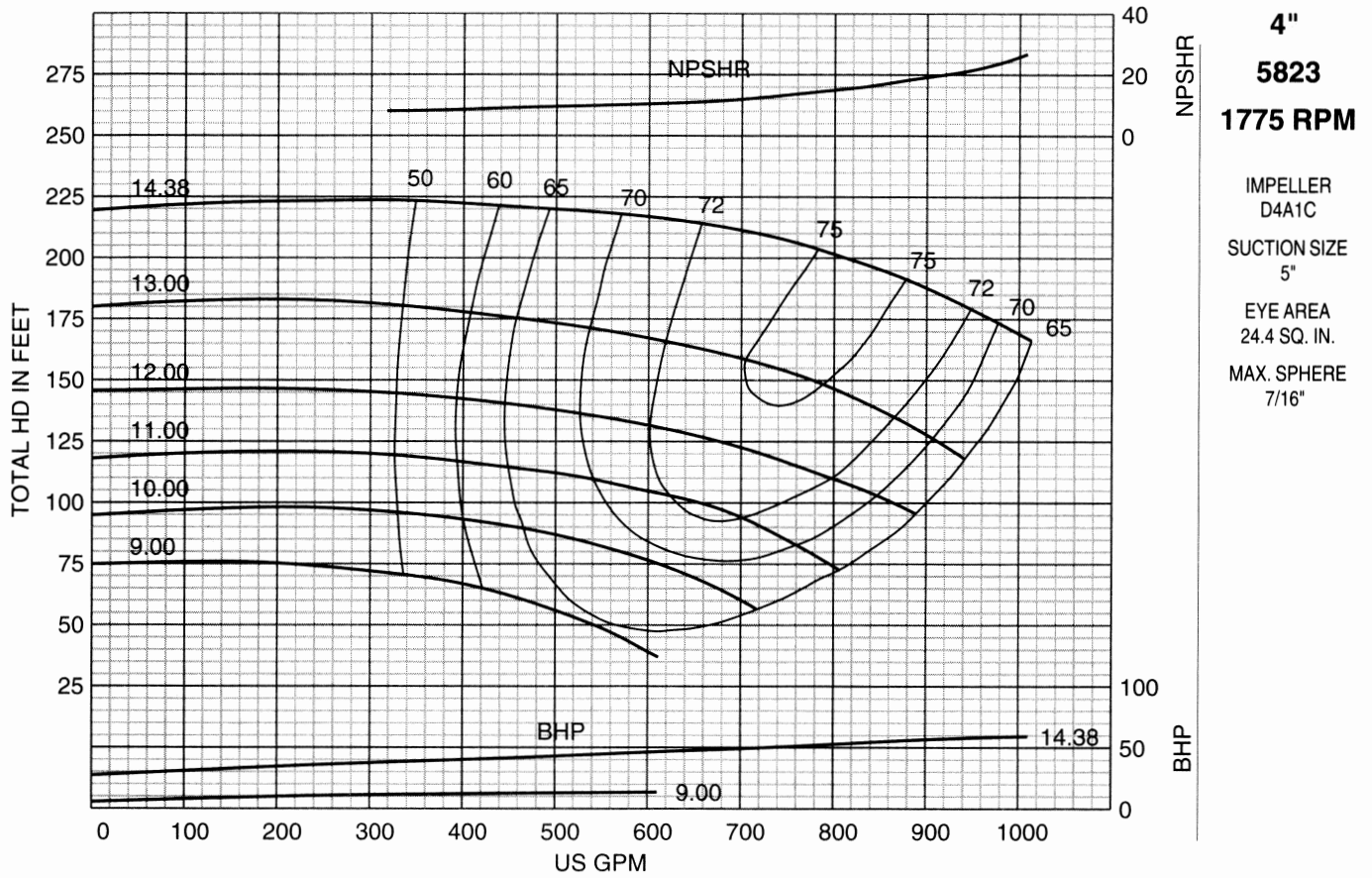



**6"**  
**5823**  
**1780 RPM**

IMPELLER  
 D6A1F  
 SUCTION SIZE  
 8"  
 EYE AREA  
 49.2 SQ. IN.  
 MAX. SPHERE  
 7/8"

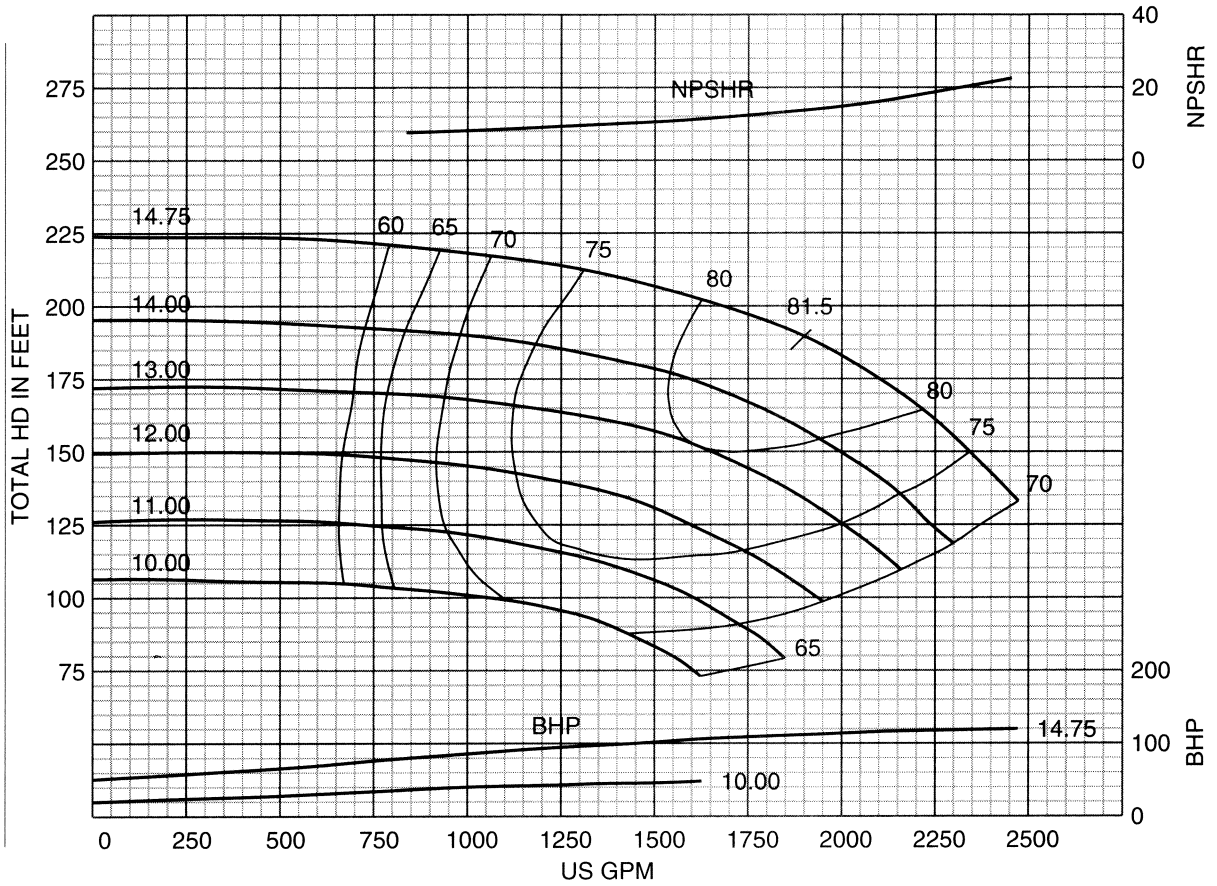

**8"**  
**5823**  
**1785 RPM**

IMPELLER  
 D8A1F  
 SUCTION SIZE  
 10"  
 EYE AREA  
 64.4 SQ. IN.  
 MAX. SPHERE  
 15/16"

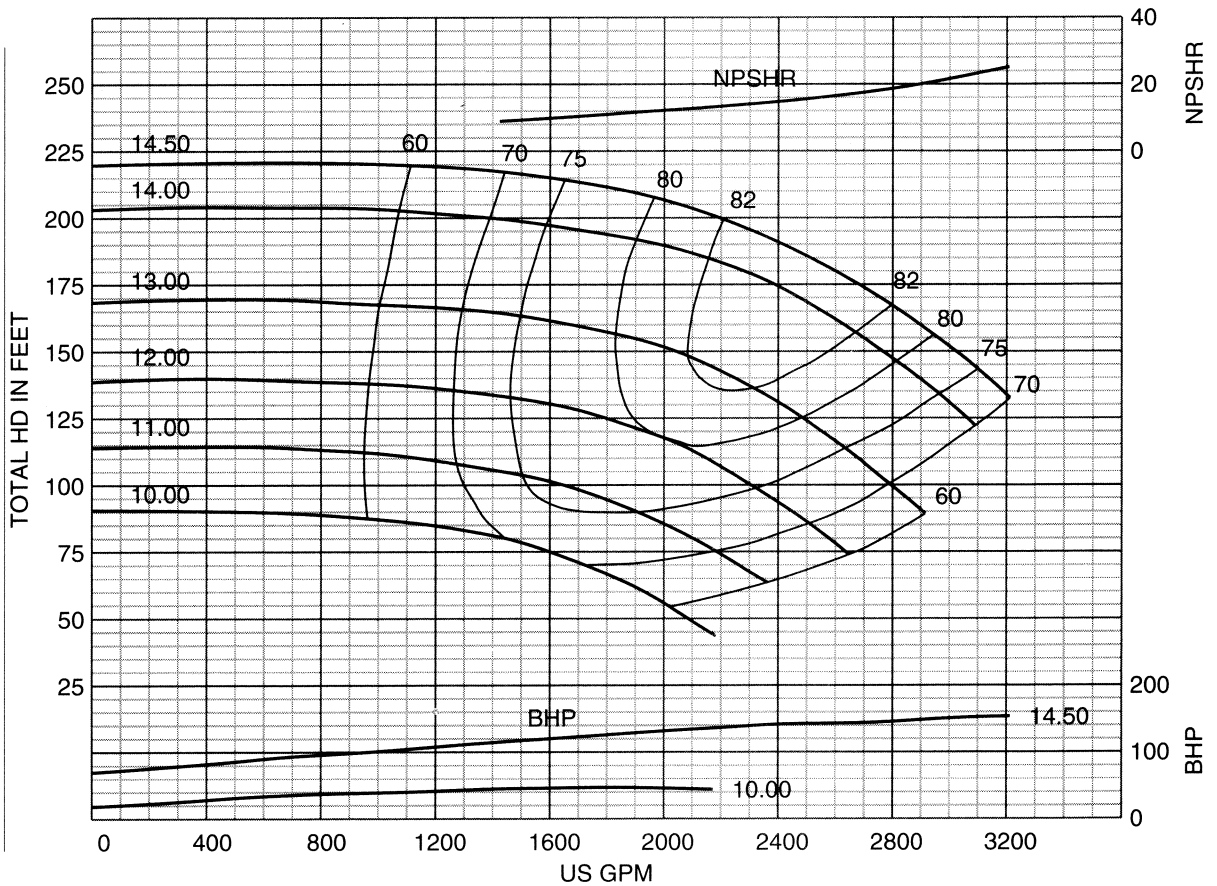

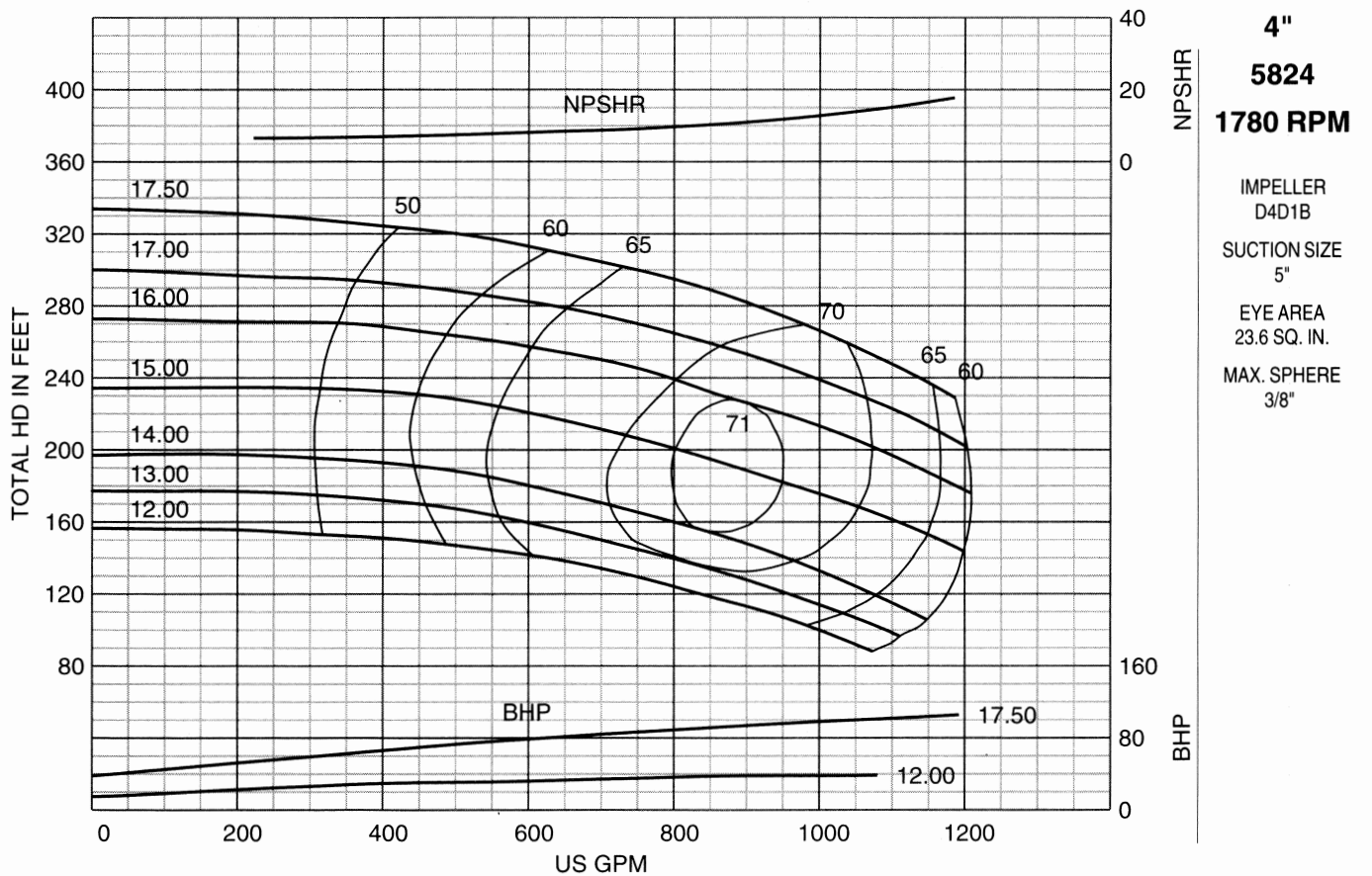
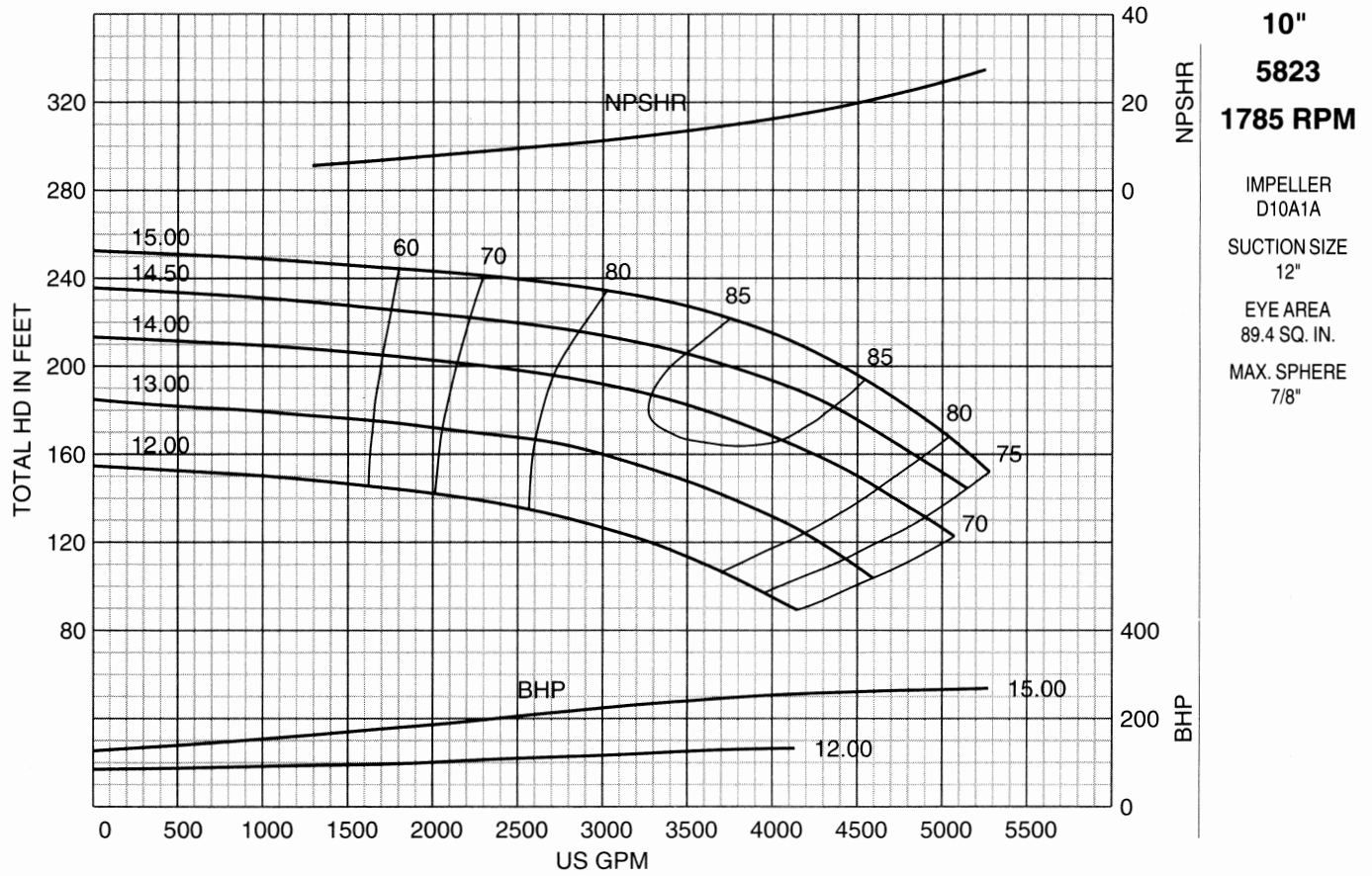



**5"**  
**5824**  
**1785 RPM**

IMPELLER  
D5D1F  
SUCTION SIZE  
6"  
EYE AREA  
30.4 SQ. IN.  
MAX. SPHERE  
5/8"

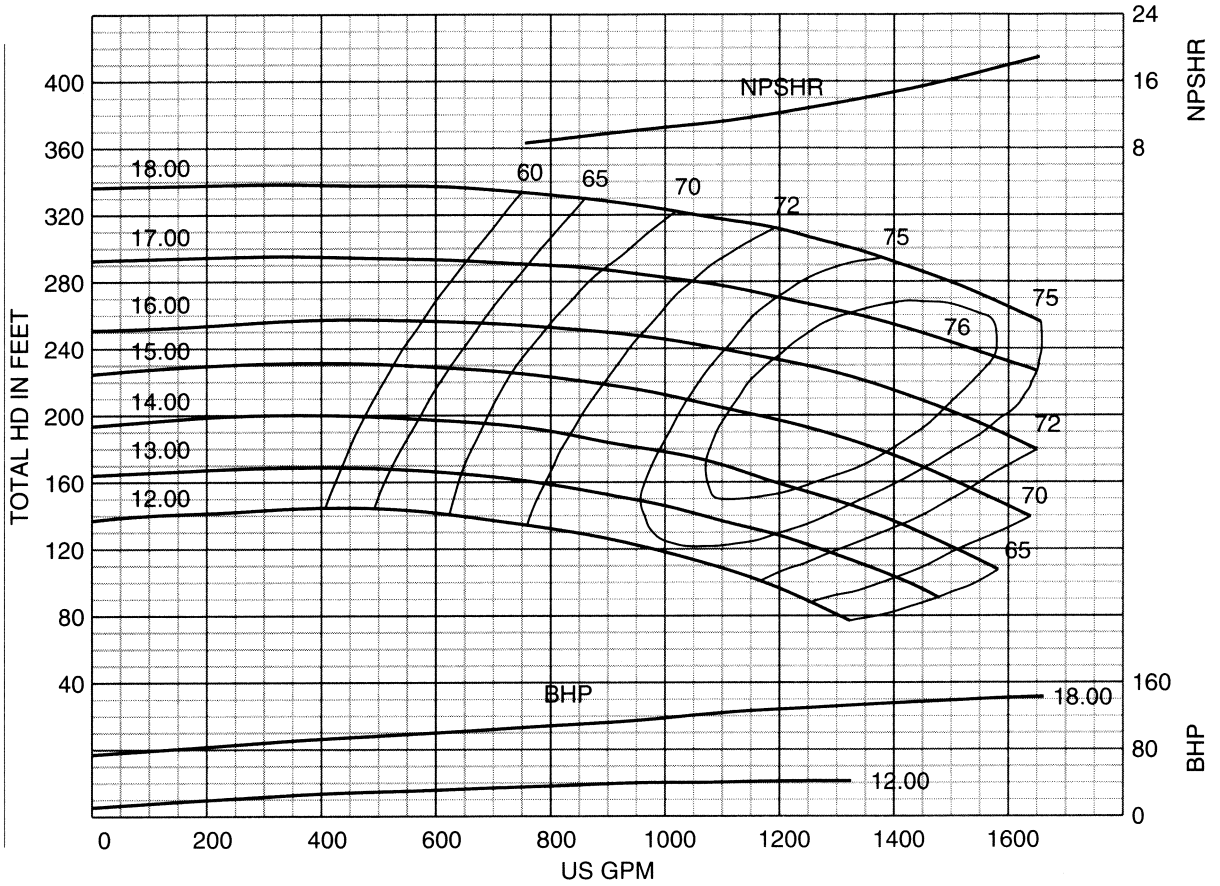

**6"**  
**5824**  
**1785 RPM**

IMPELLER  
D6D1AM  
SUCTION SIZE  
8"  
EYE AREA  
51.6 SQ. IN.  
MAX. SPHERE  
7/8"

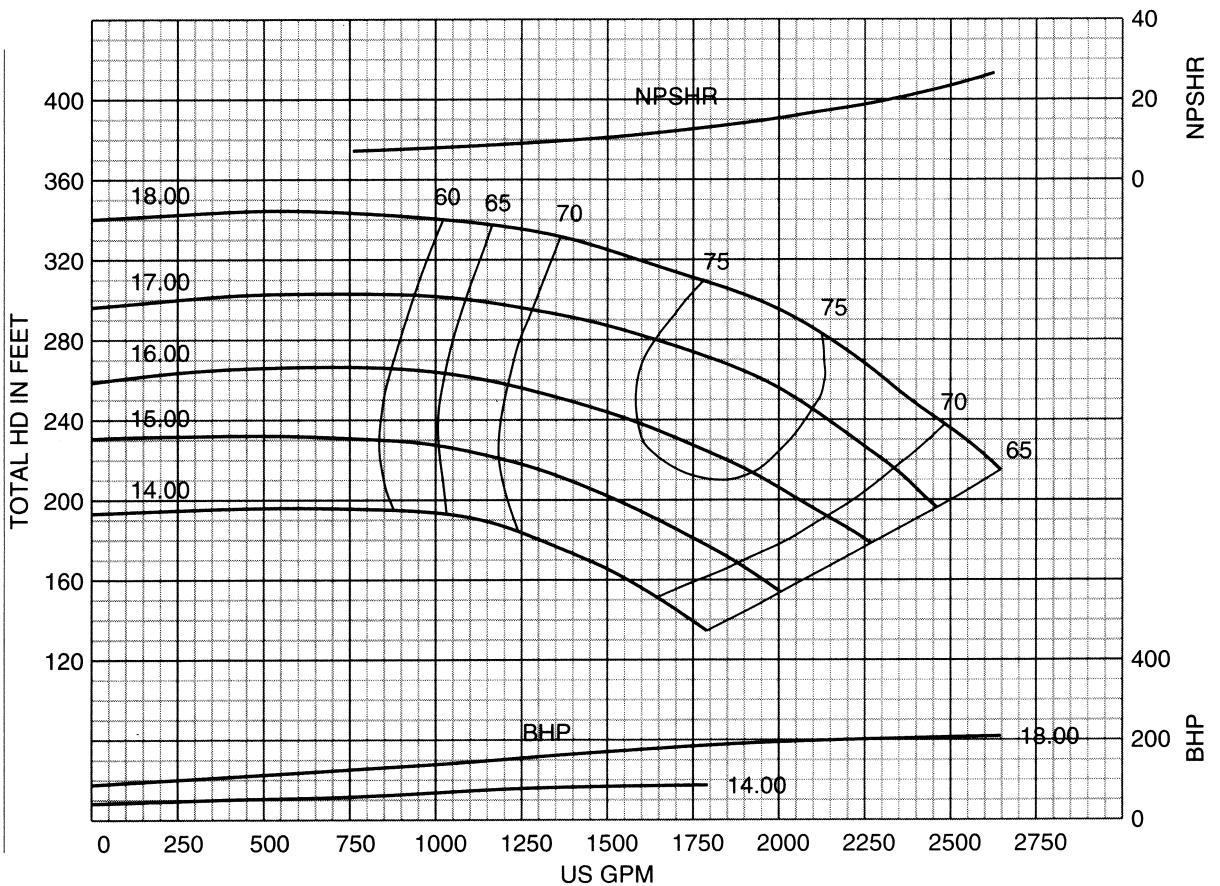



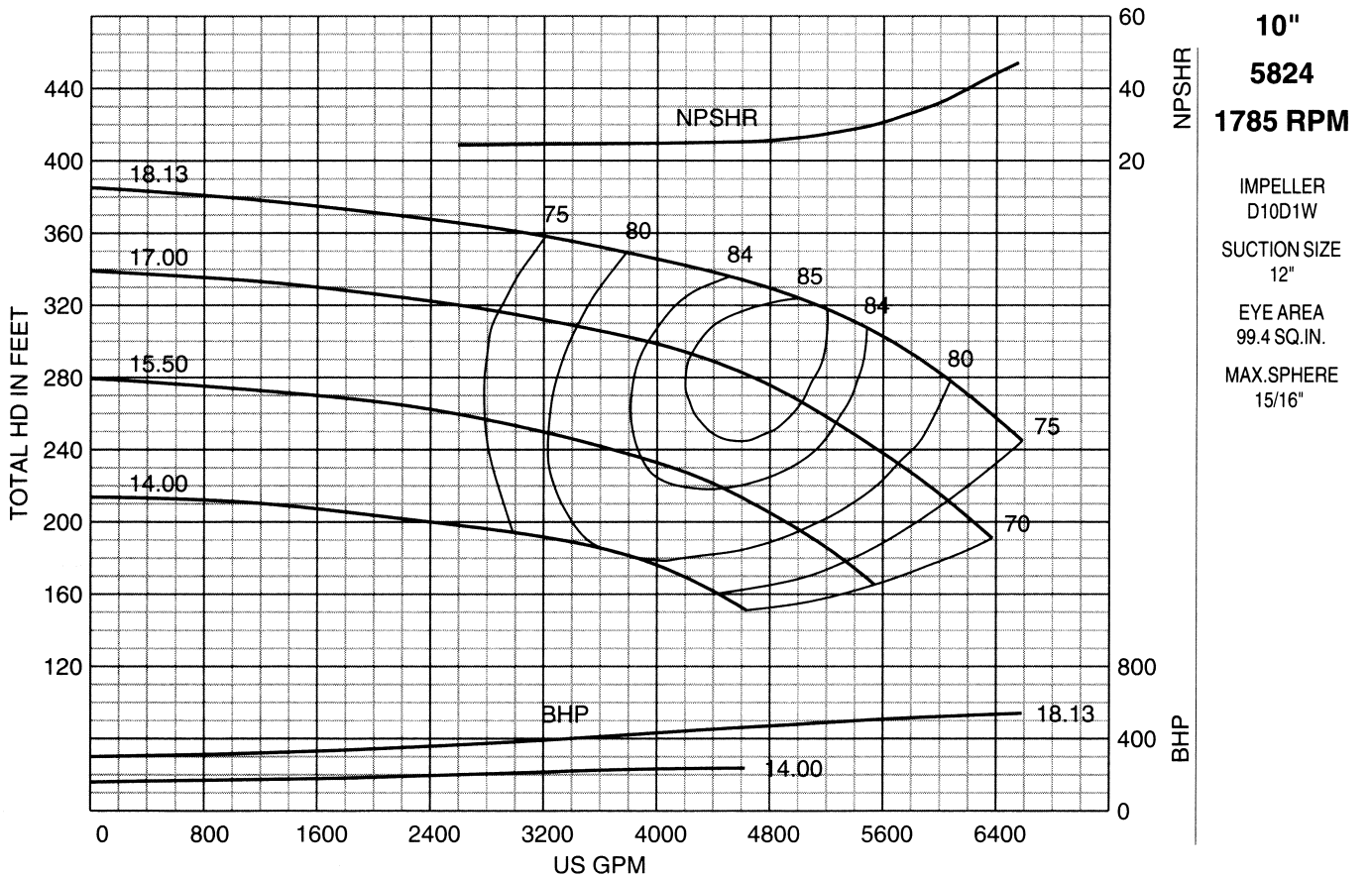
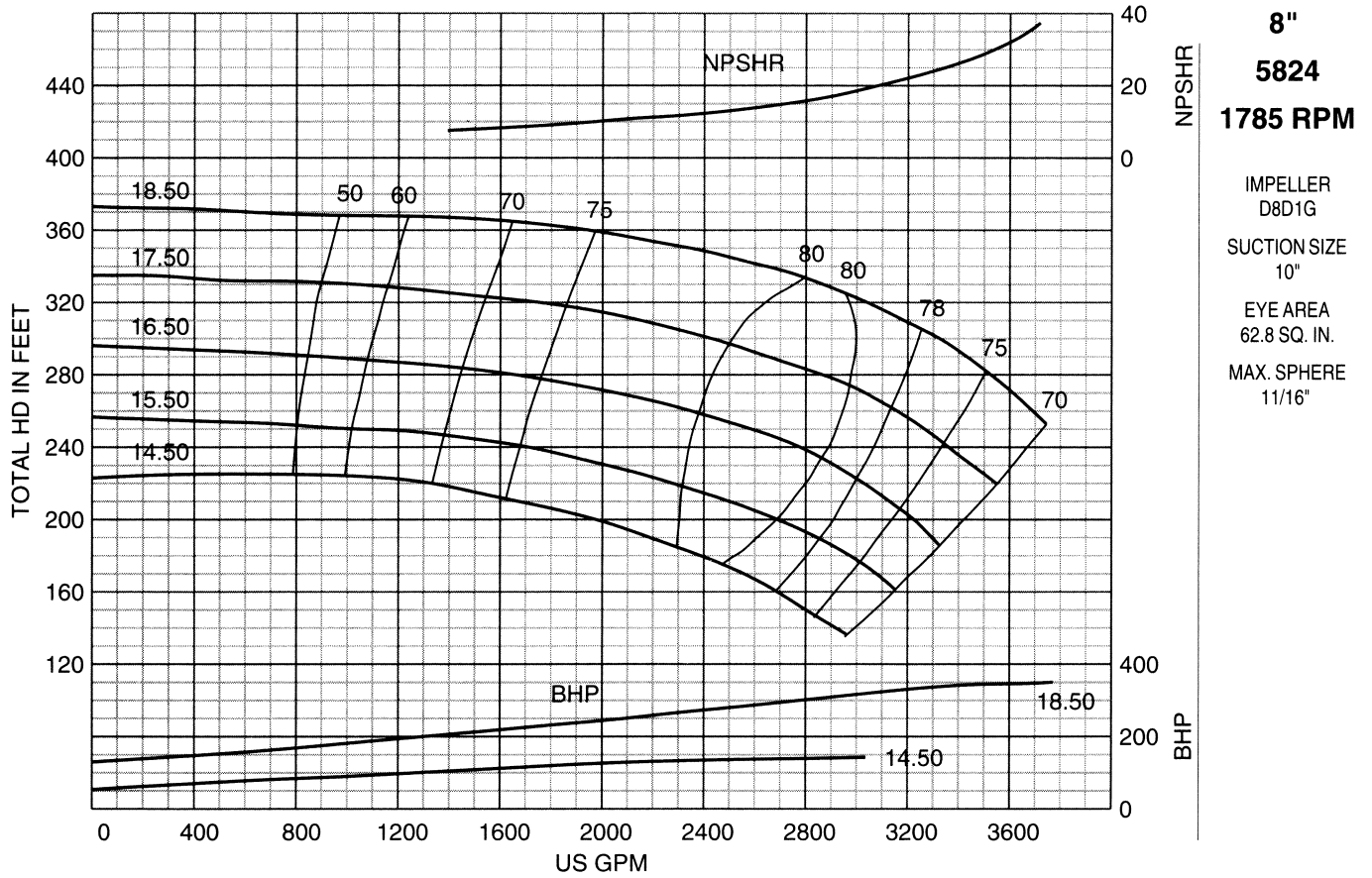

**6"**  
**5826**  
**1785 RPM**

IMPELLER  
D6F1A  
SUCTION SIZE  
10"  
EYE AREA  
52.2 SQ.IN.  
MAX.SPHERE  
7/8"

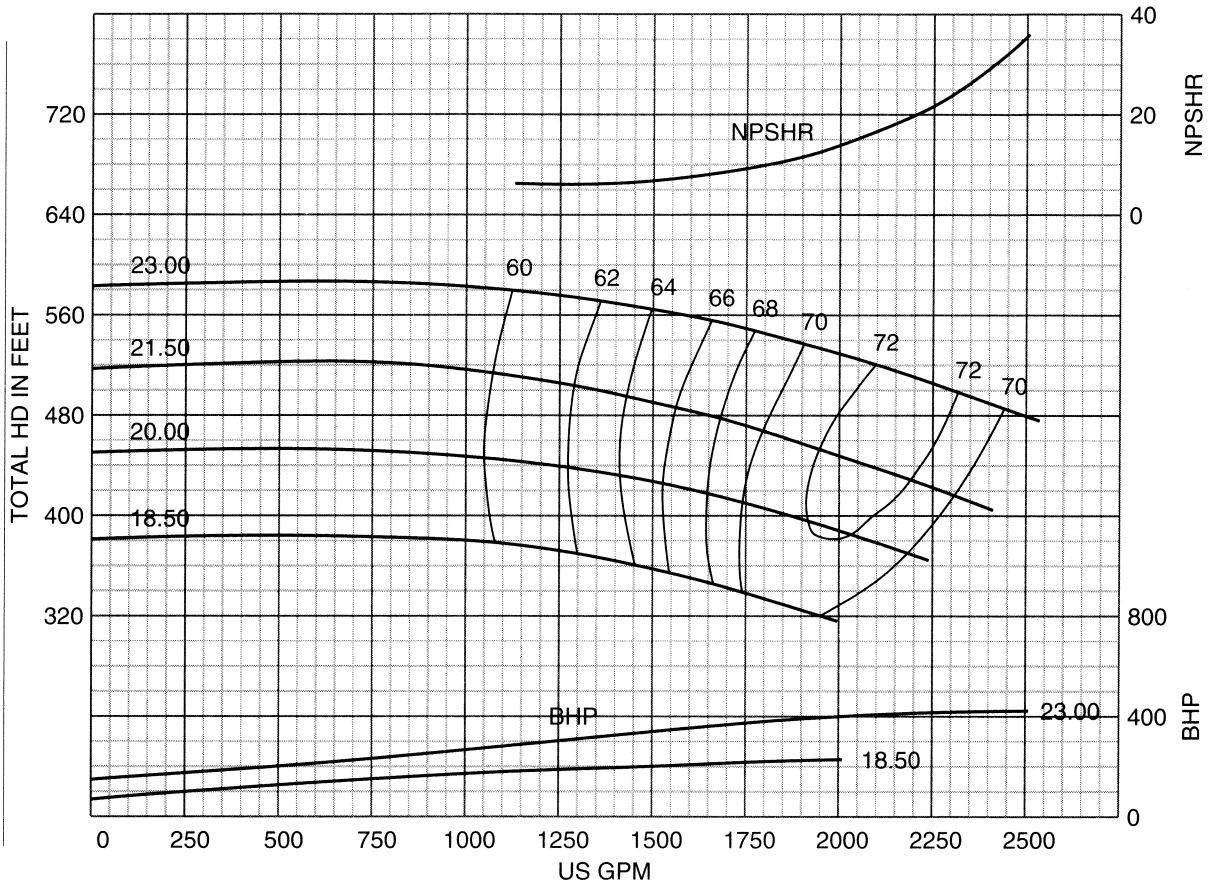

**8"**  
**5826**  
**1785 RPM**

IMPELLER  
D8F1A  
SUCTION SIZE  
12"  
EYE AREA  
76.9 SQ.IN.  
MAX.SPHERE  
1"

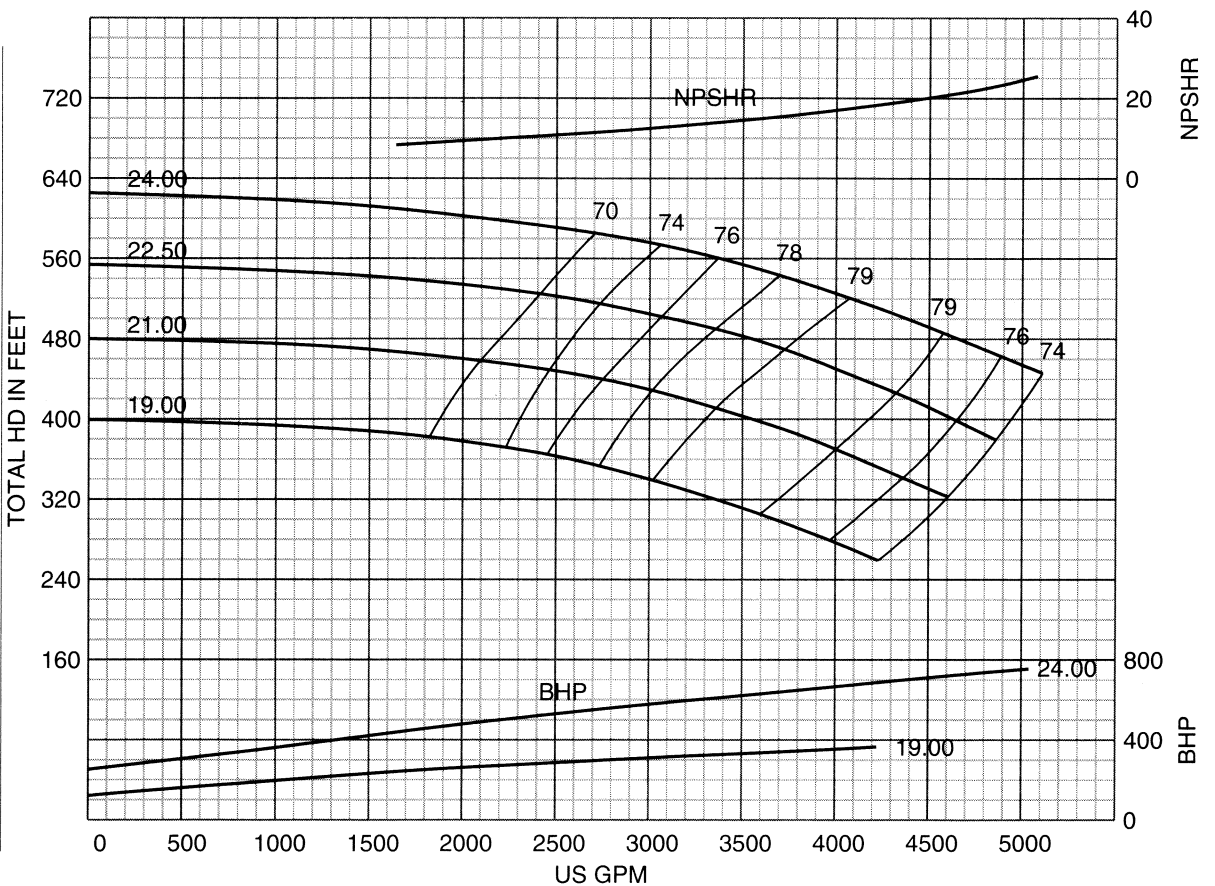



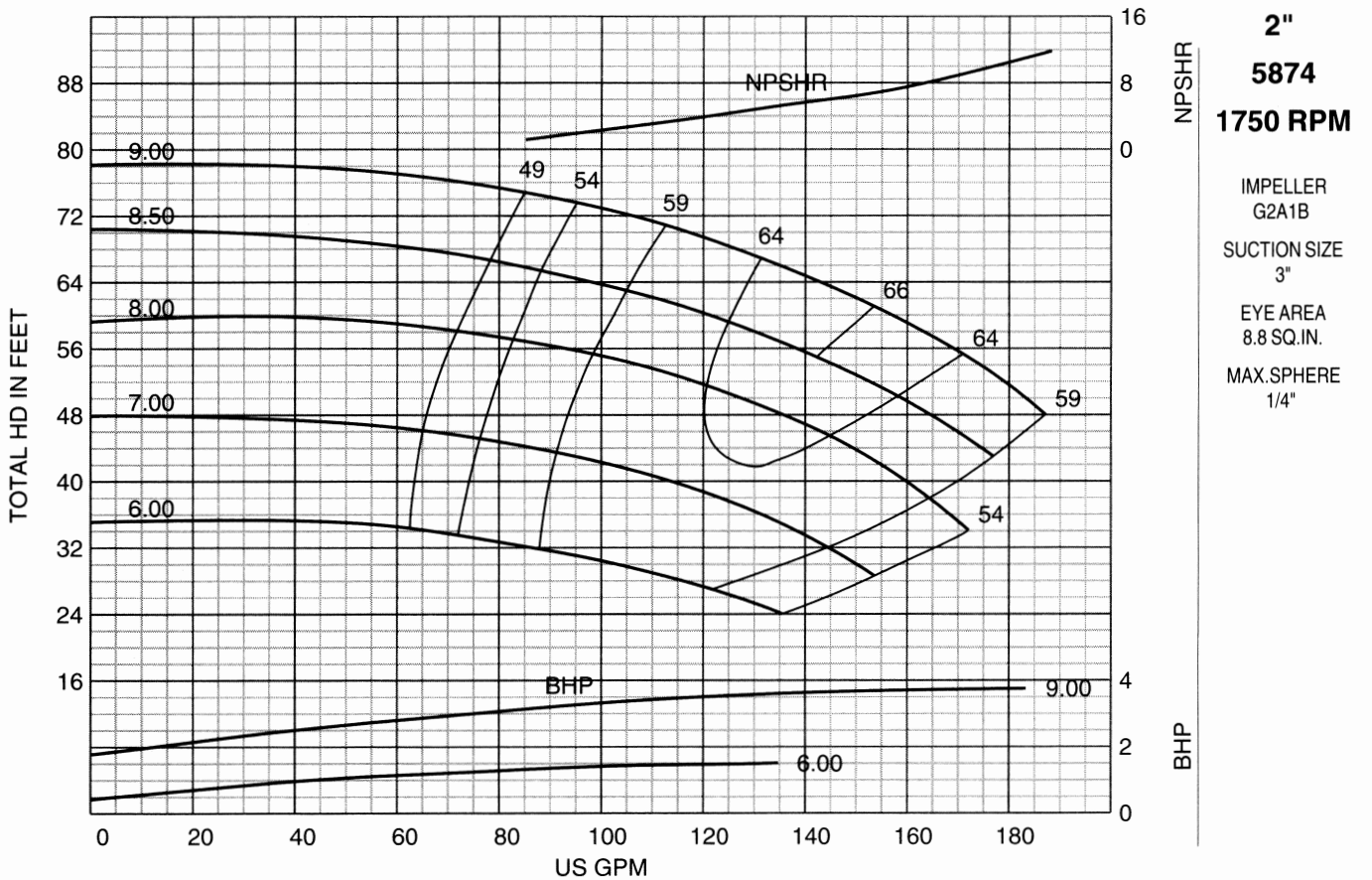
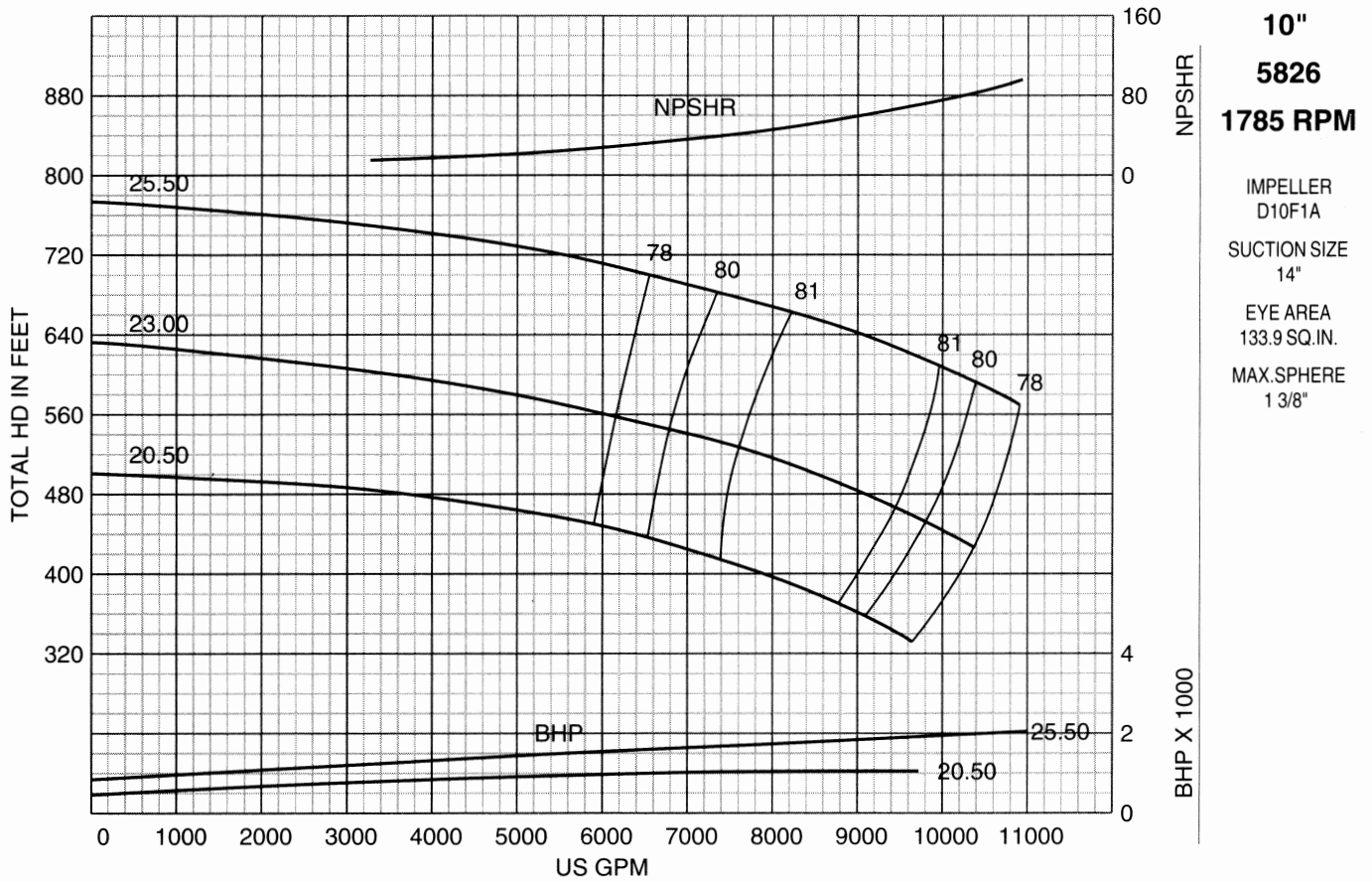

**3"**  
**5874**  
**1750 RPM**  
 IMPELLER  
 G3A1B  
 SUCTION SIZE  
 4"  
 EYE AREA  
 10.6 SQ. IN.  
 MAX. SPHERE  
 .4375"

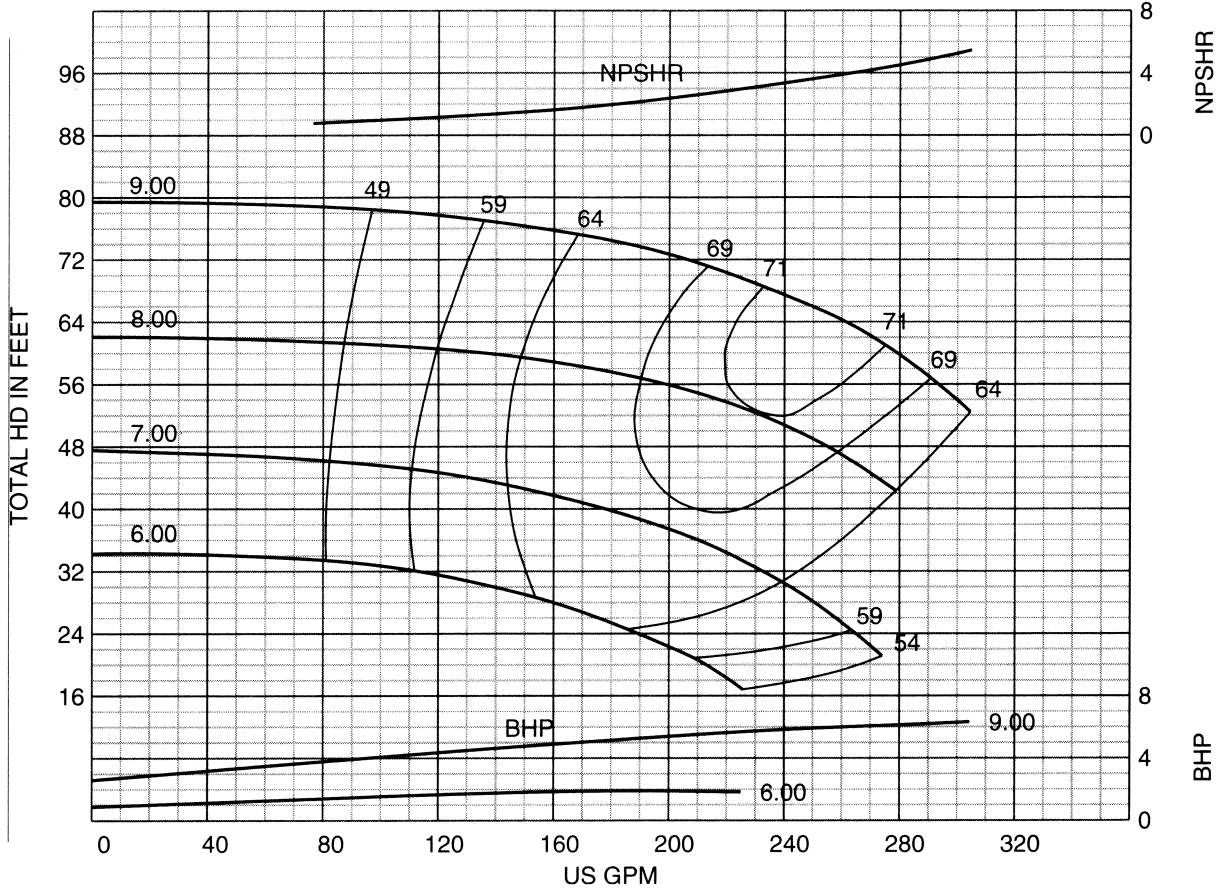

**4"**  
**5874**  
**1760 RPM**  
 IMPELLER  
 G4A1A  
 SUCTION SIZE  
 5"  
 EYE AREA  
 16.6 SQ. IN.  
 MAX. SPHERE  
 .5"

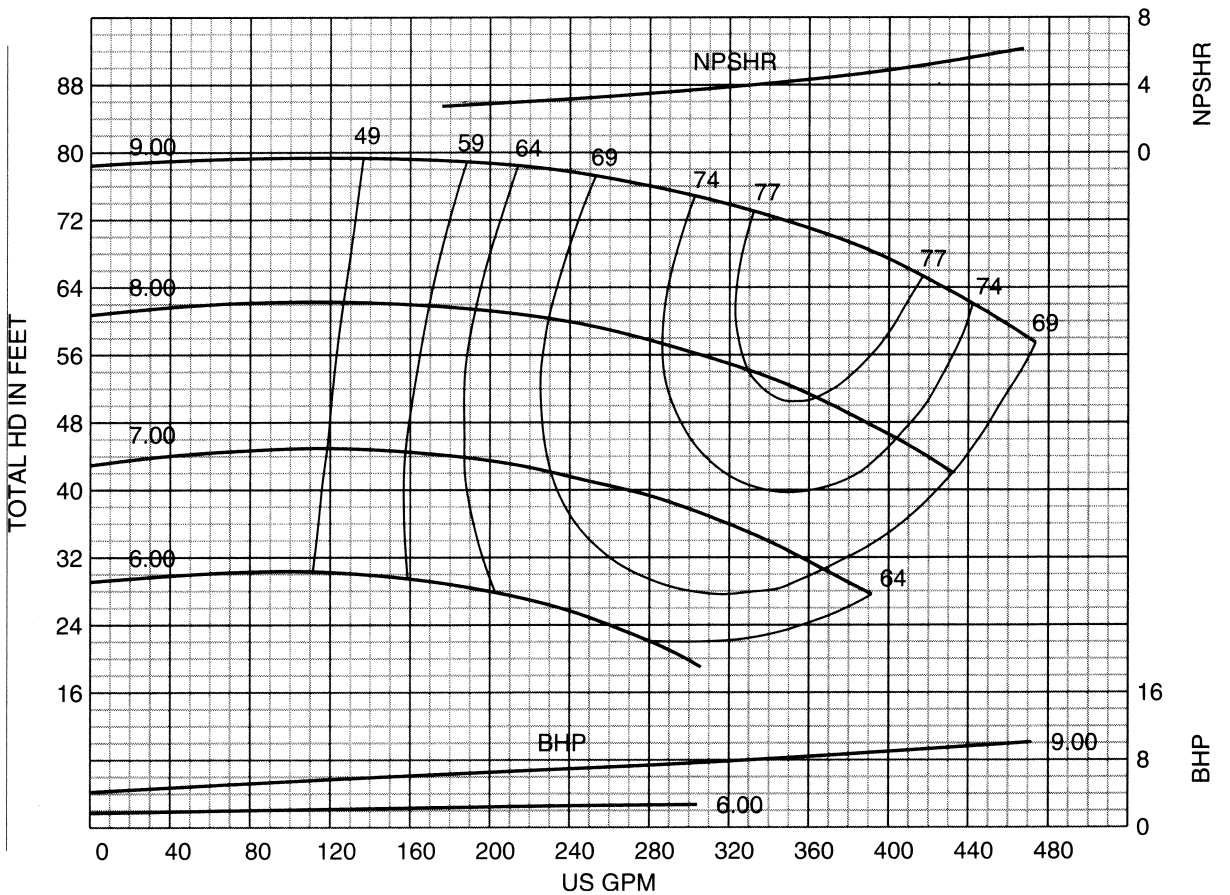



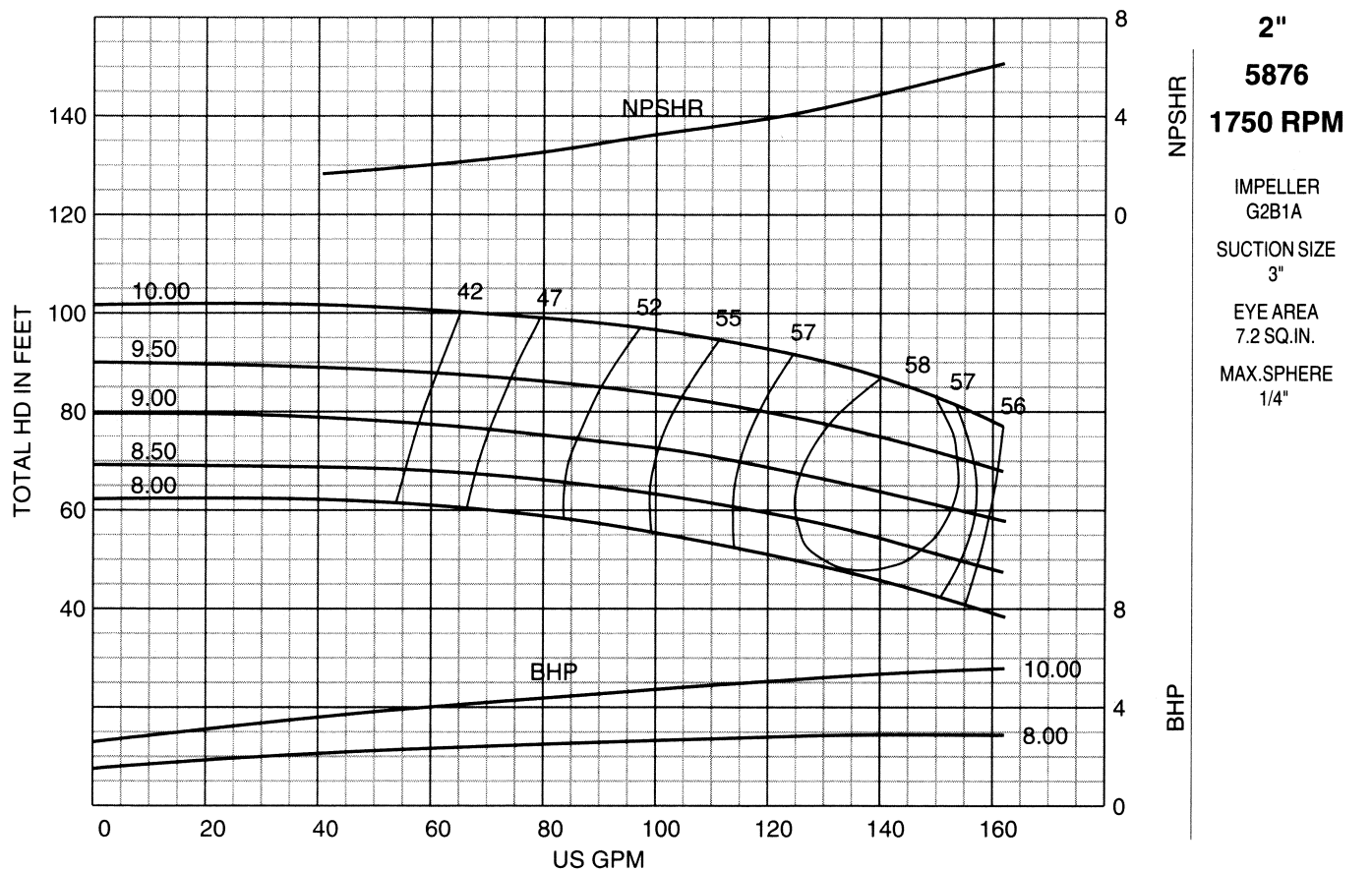
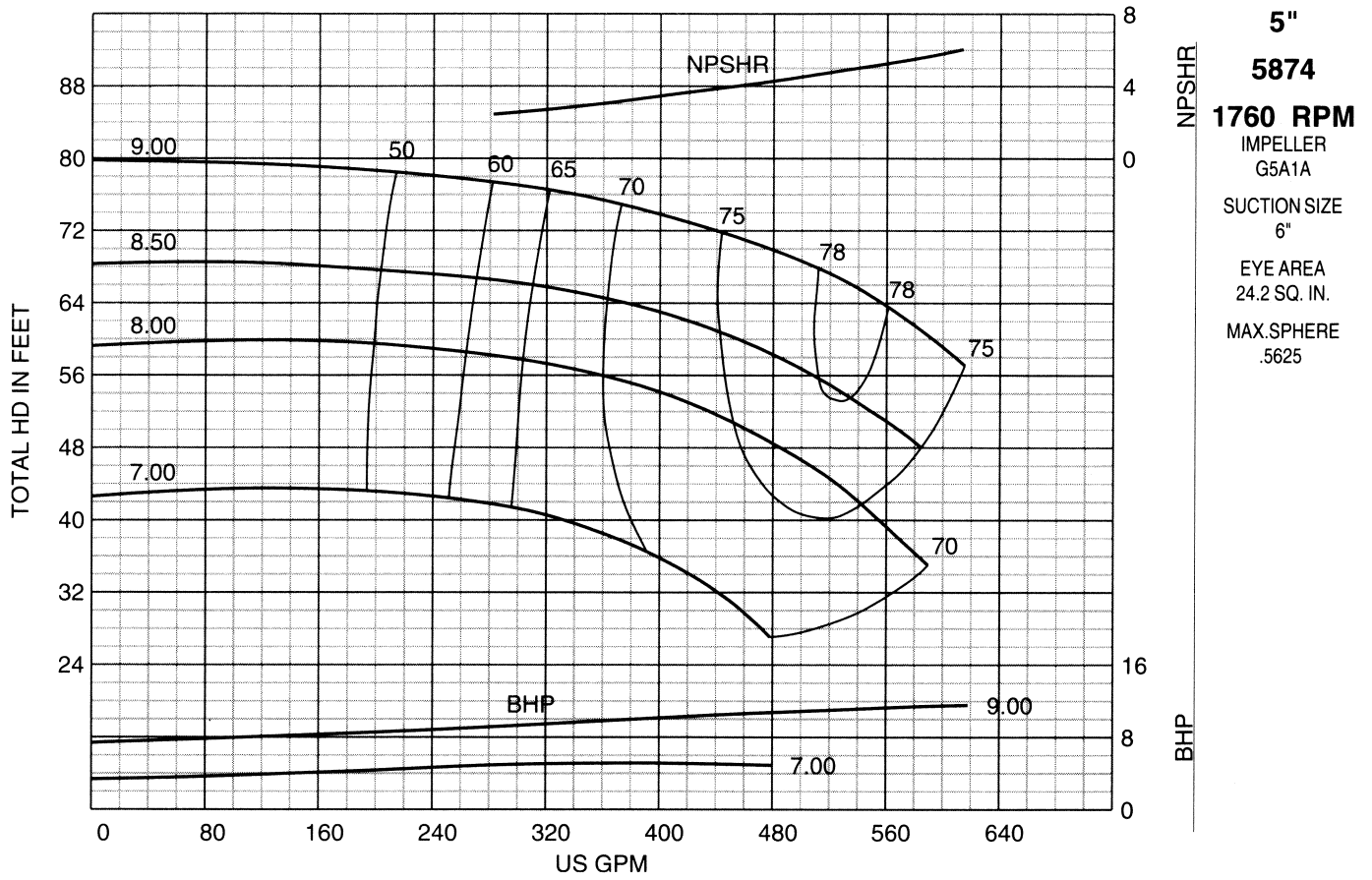

**3"**  
**5876**  
**1760 RPM**

IMPELLER  
G3B1A  
SUCTION SIZE  
4"  
EYE AREA  
13.0 SQ. IN.  
MAX. SPHERE  
7/16"

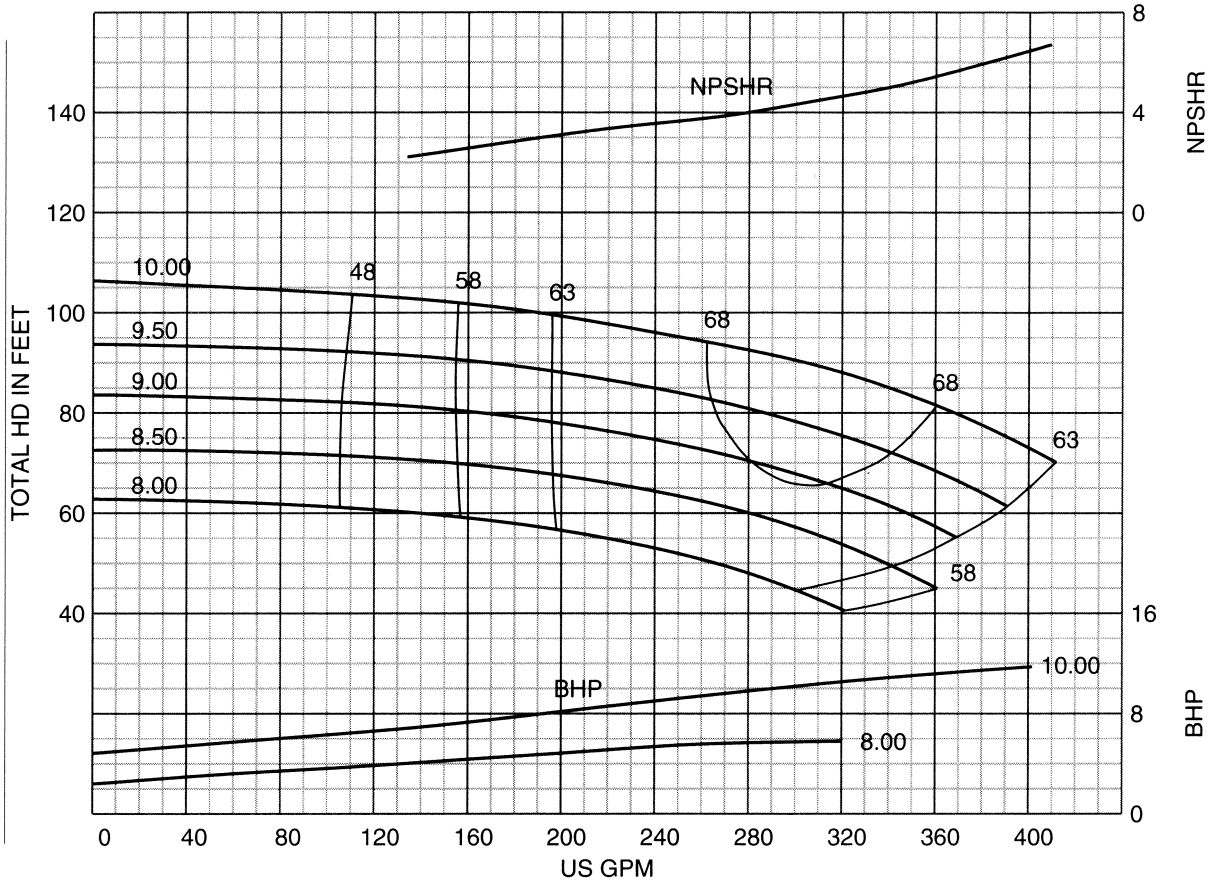

**4"**  
**5876**  
**1760 RPM**

IMPELLER  
G4B1A  
SUCTION SIZE  
6"  
EYE AREA  
21.9 SQ. IN.  
MAX. SPHERE  
.5

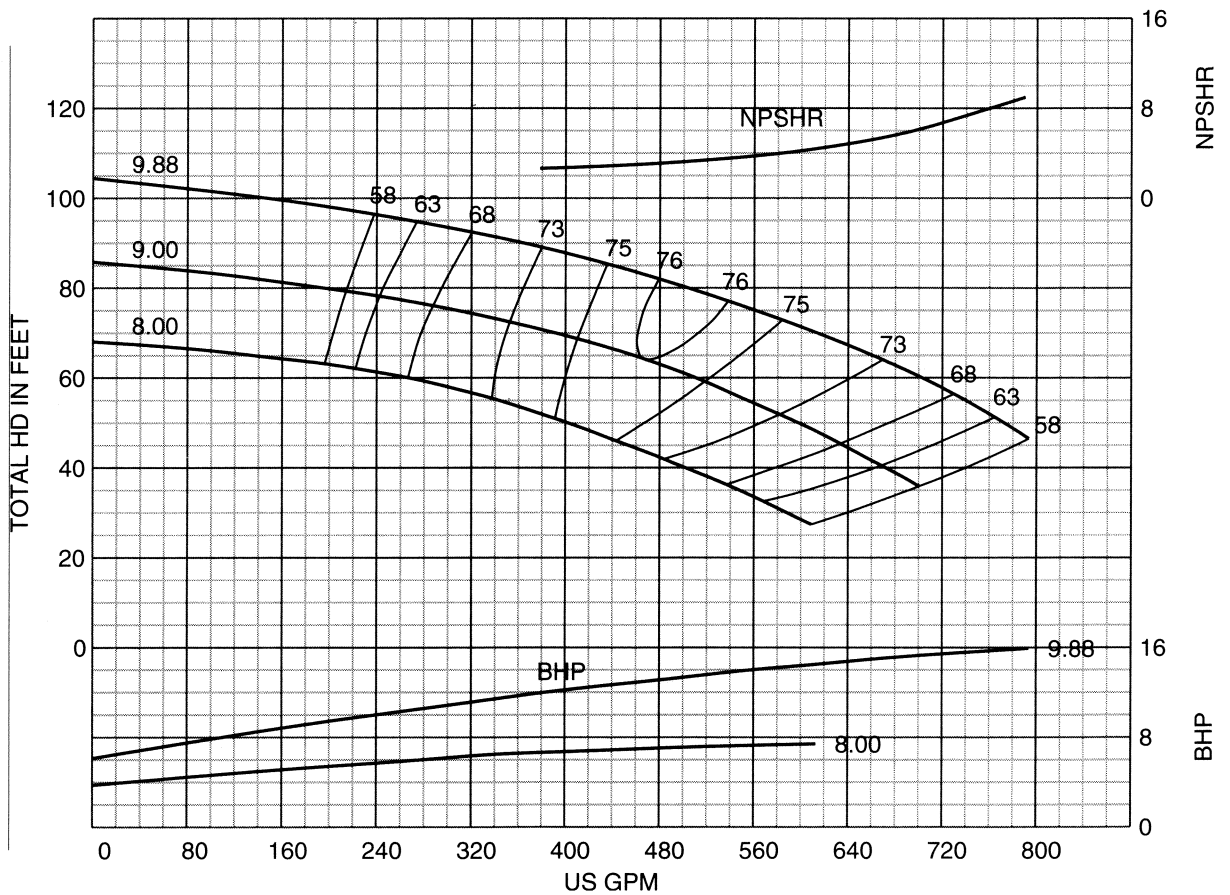



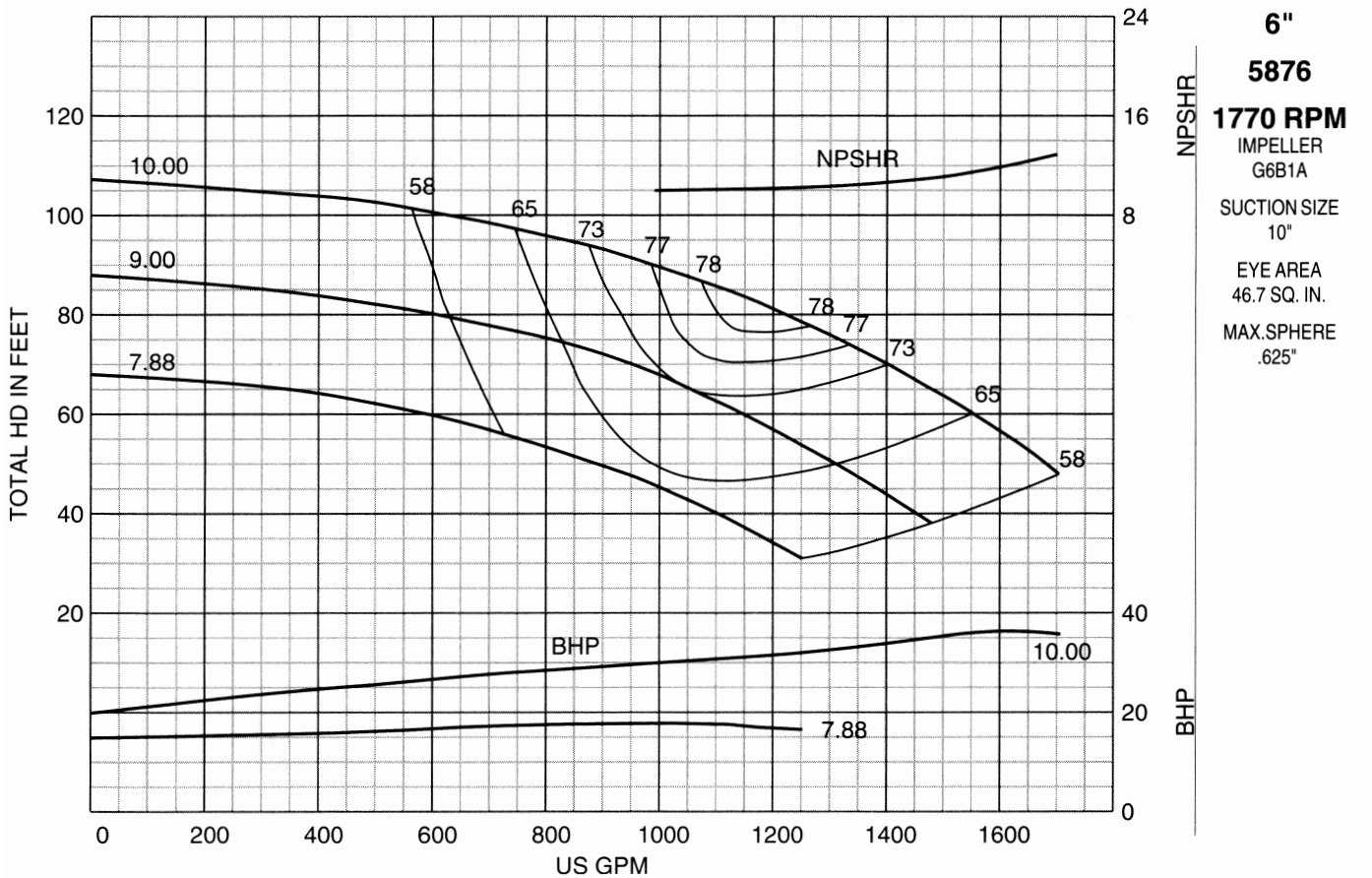
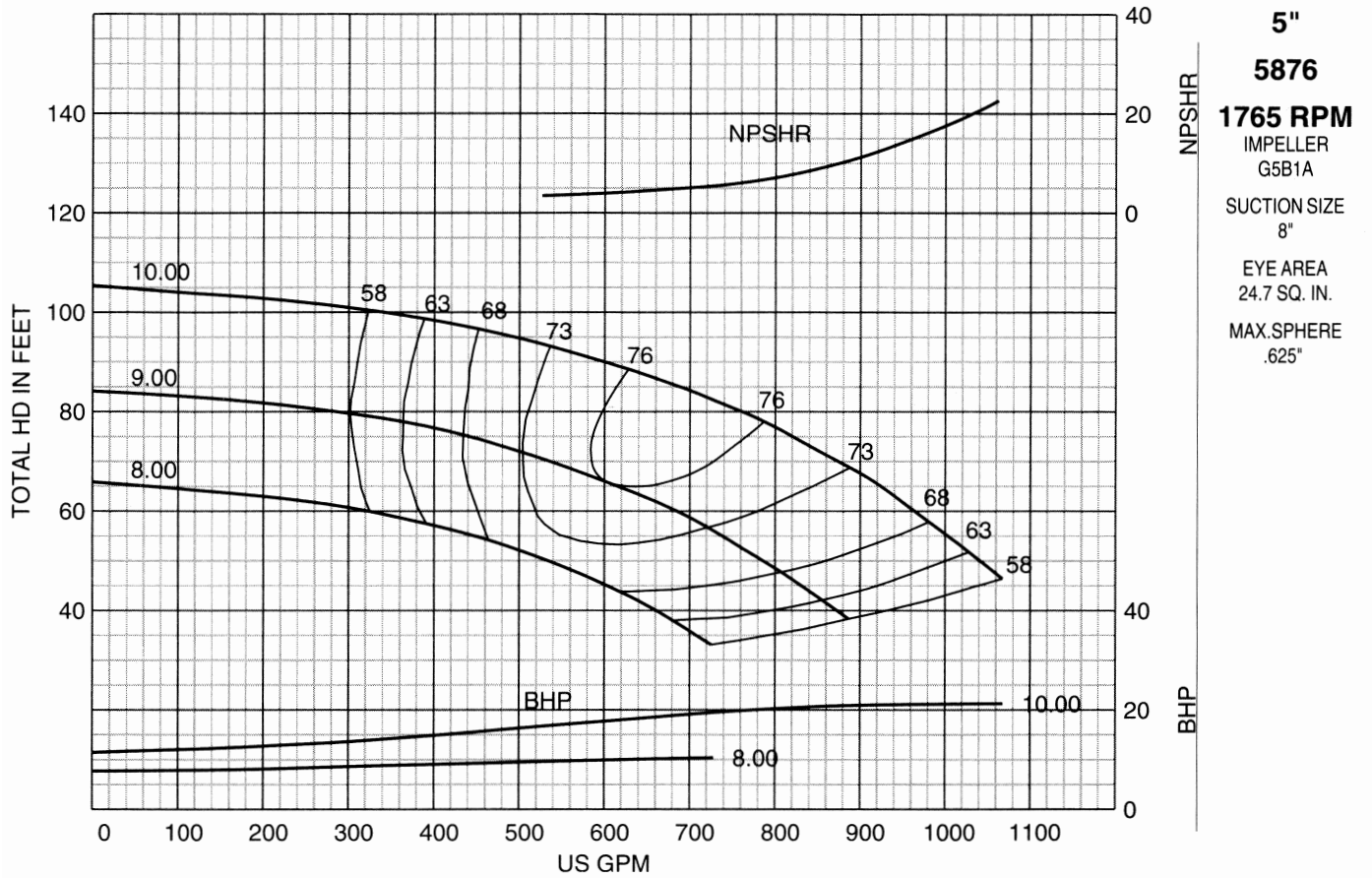

**4"**  
**5821**  
**1165 RPM**

IMPELLER  
D4C1A  
SUCTION SIZE  
5"  
EYE AREA  
20.0 SQ. IN.  
MAX. SPHERE  
5/8"

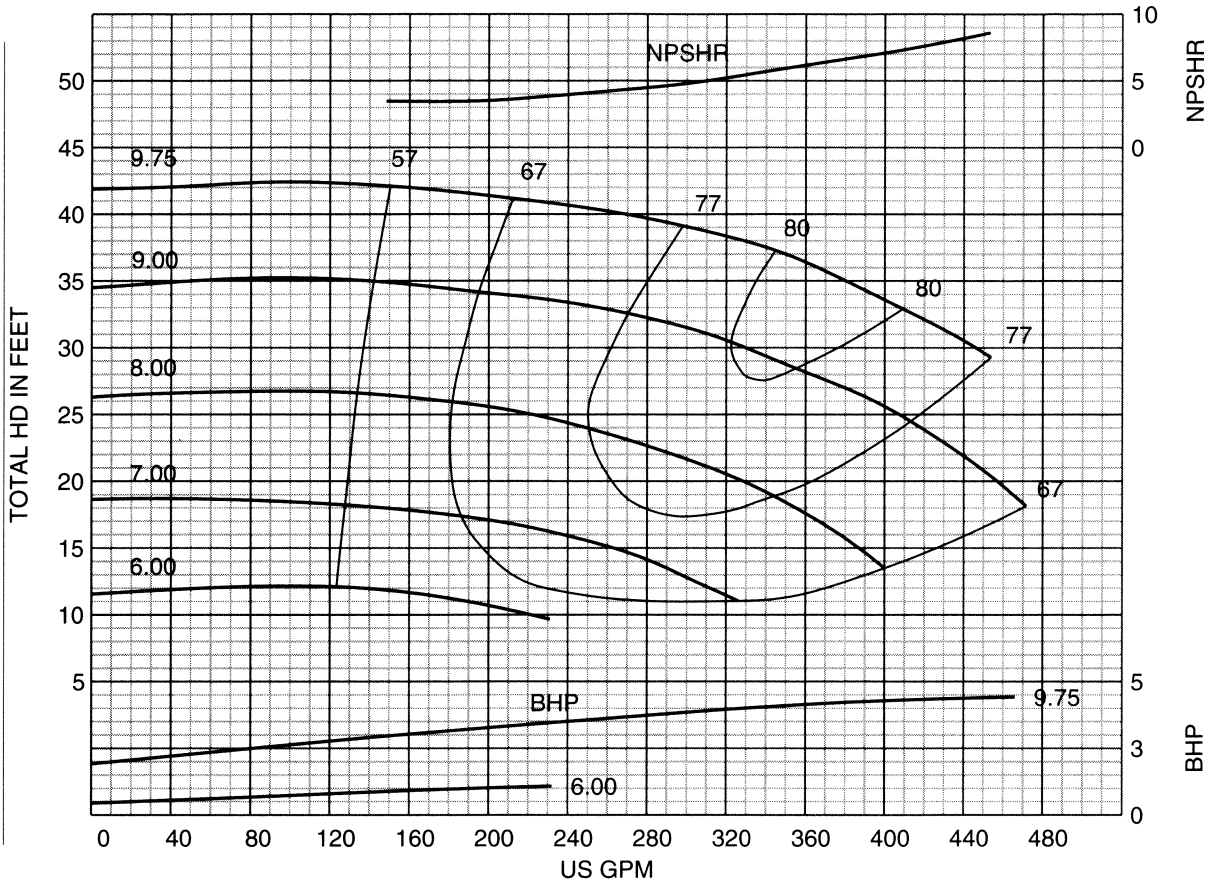

**5"**  
**5821**  
**1165 RPM**

IMPELLER  
D5C1B  
SUCTION SIZE  
6"  
EYE AREA  
25.0 SQ. IN.  
MAX. SPHERE  
3/4"

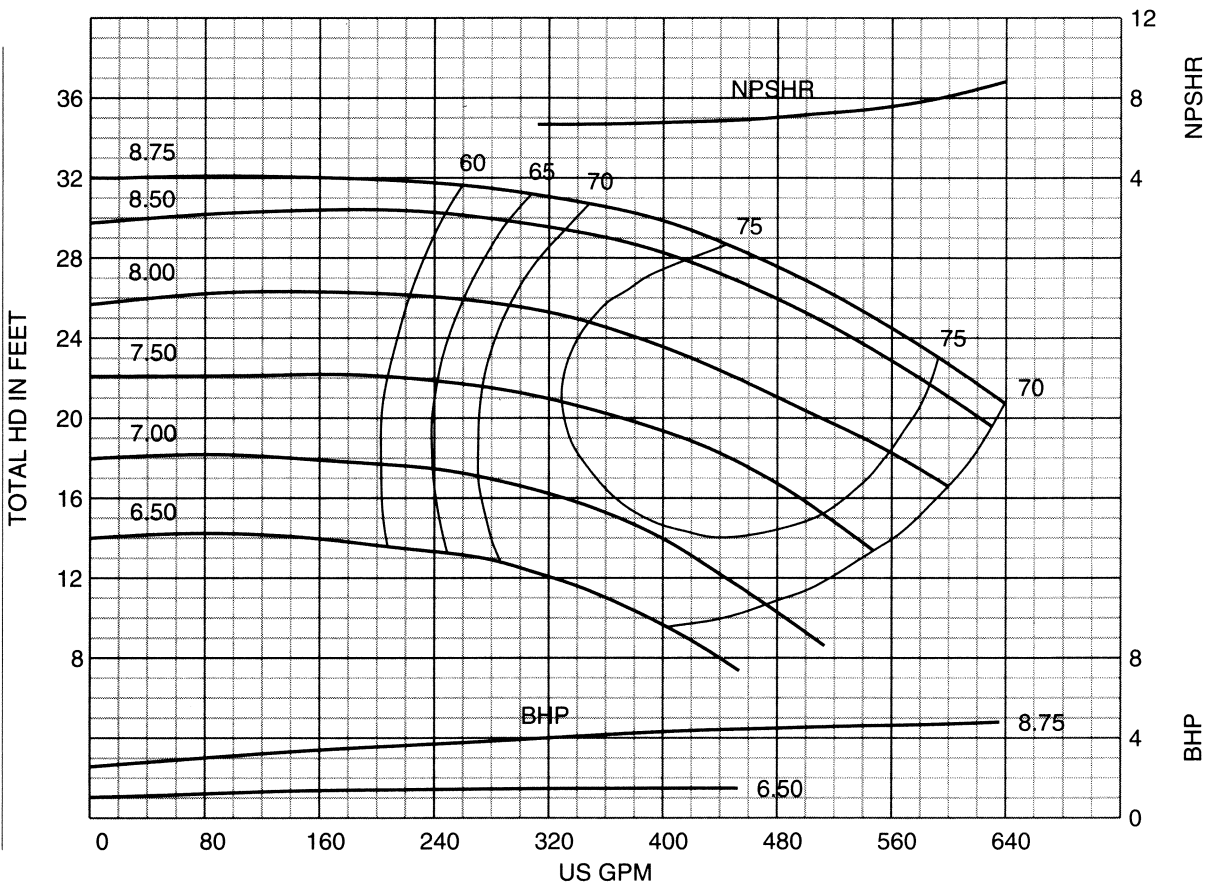



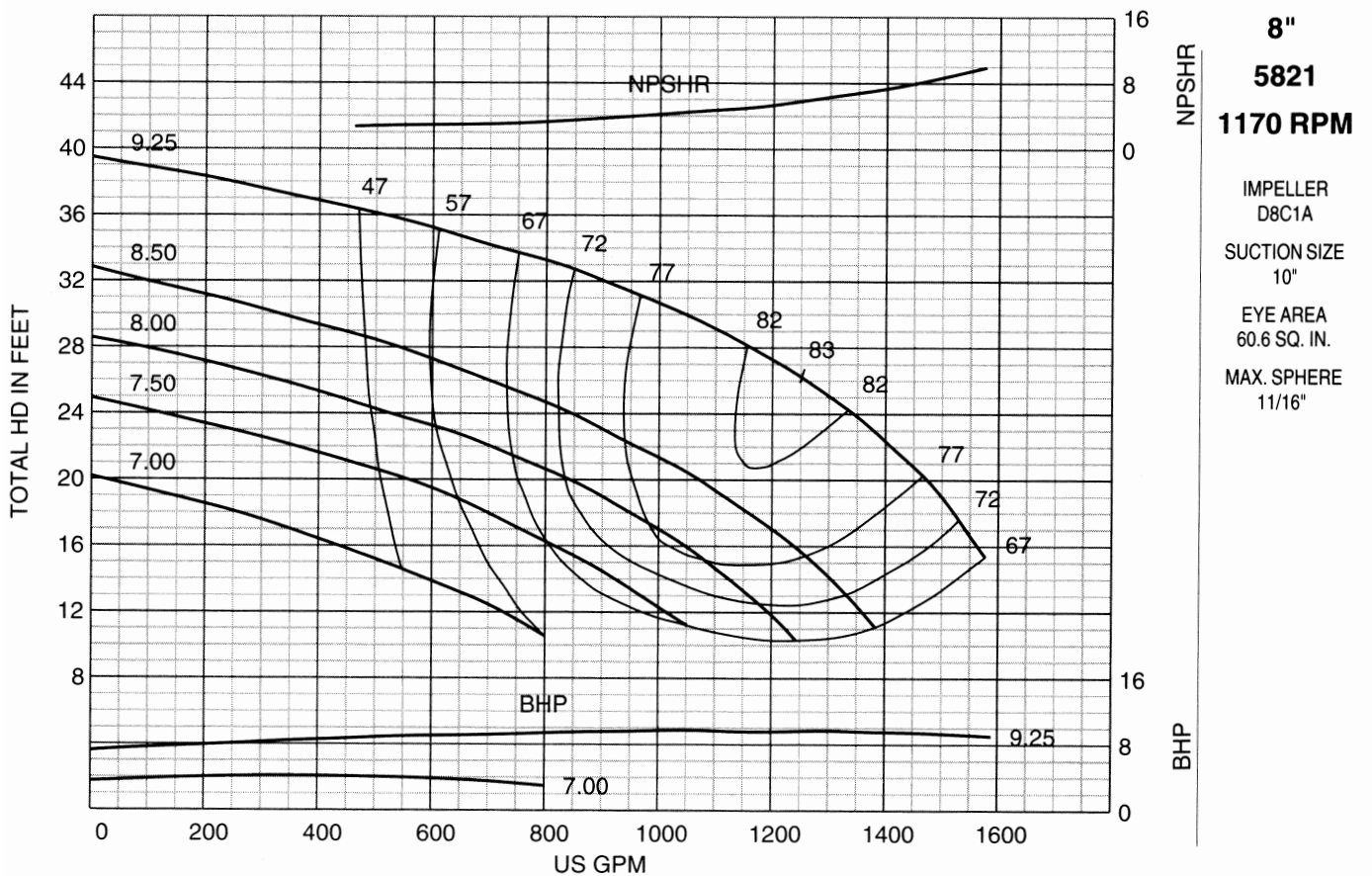
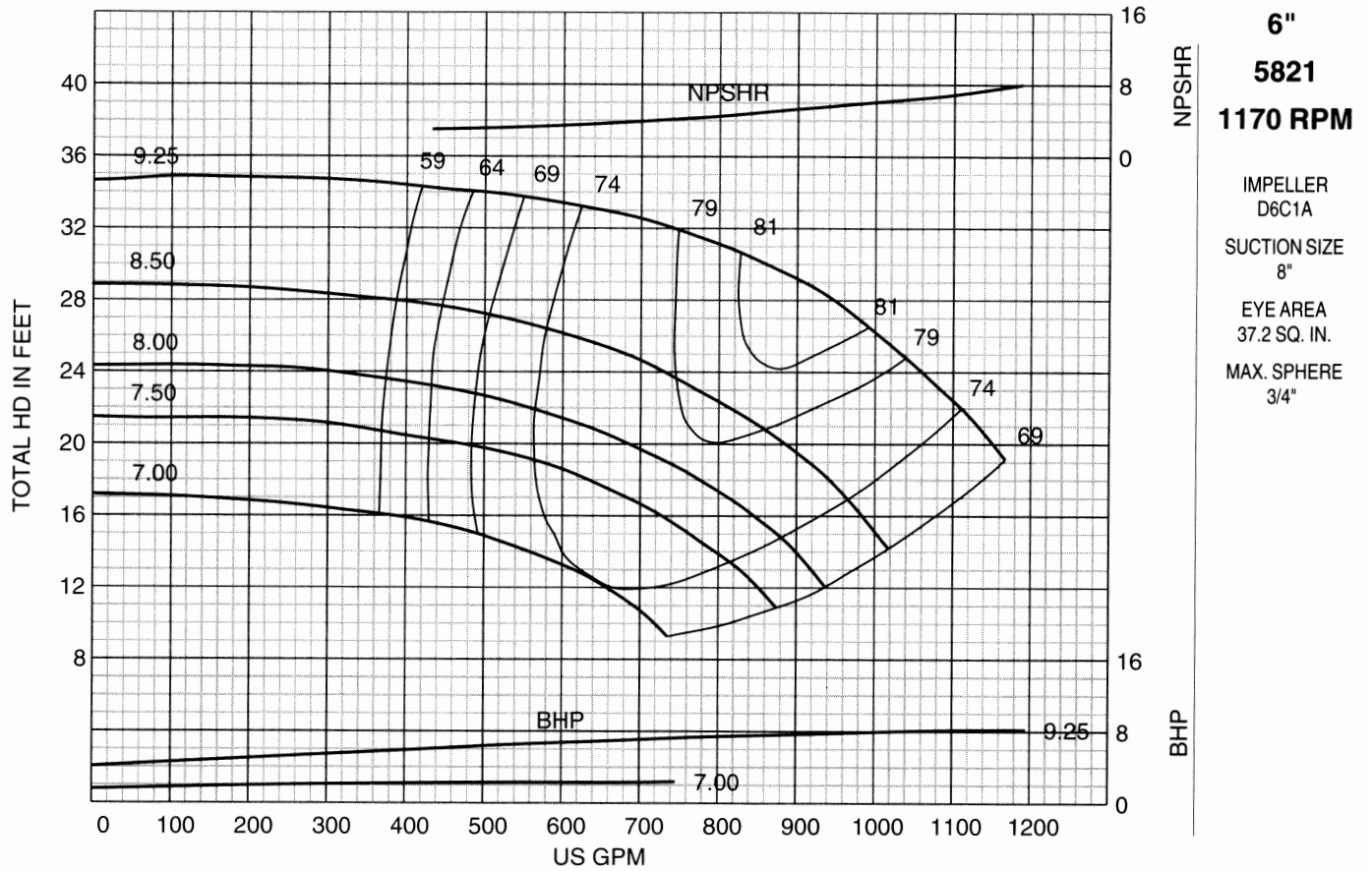

**8"**  
**5821**  
**1175 RPM**

IMPELLER  
 D8C1C  
 SUCTION SIZE  
 10"  
 EYE AREA  
 64.6 SQ. IN.  
 MAX. SPHERE  
 11/16"

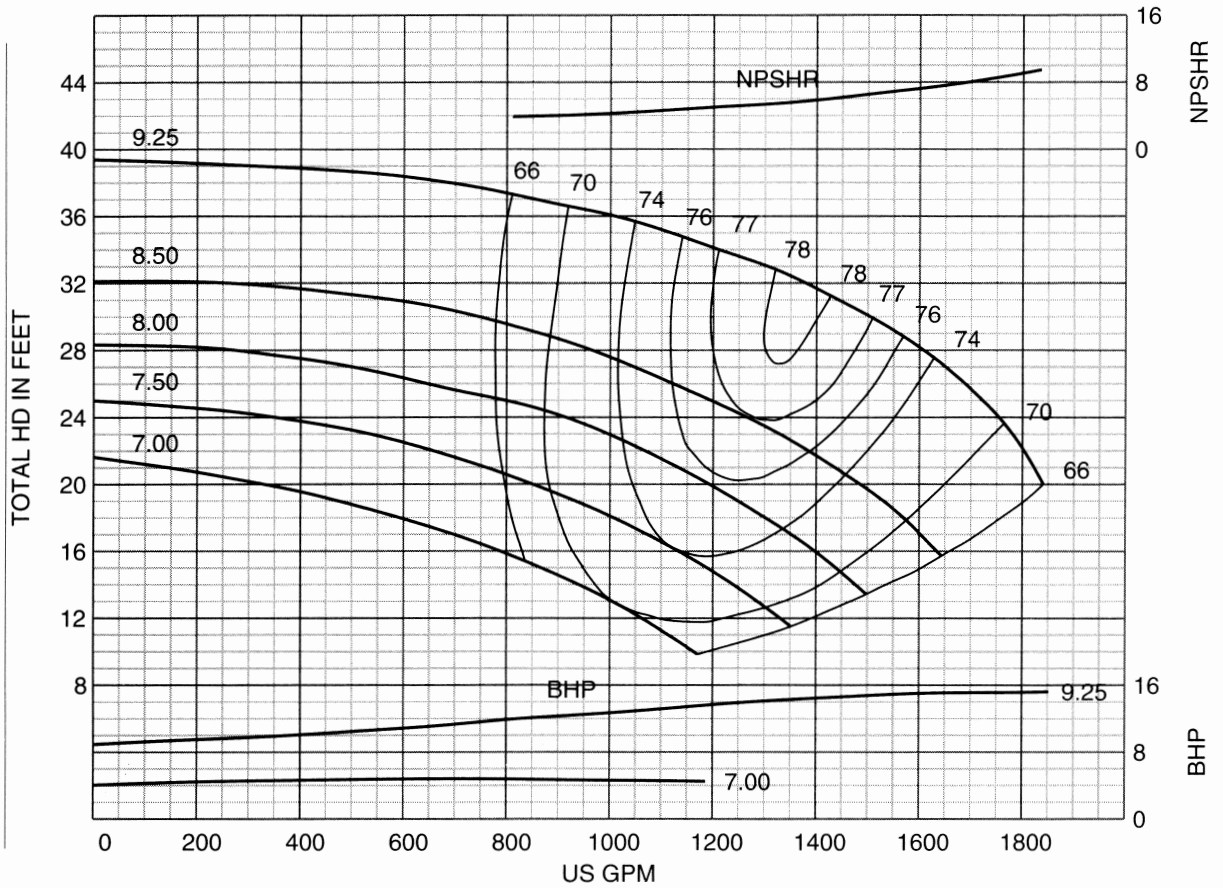

**10"**  
**5821**  
**1185 RPM**

IMPELLER  
 D10C1A  
 SUCTION SIZE  
 12"  
 EYE AREA  
 84.4 SQ. IN.  
 MAX. SPHERE  
 1 1/8"

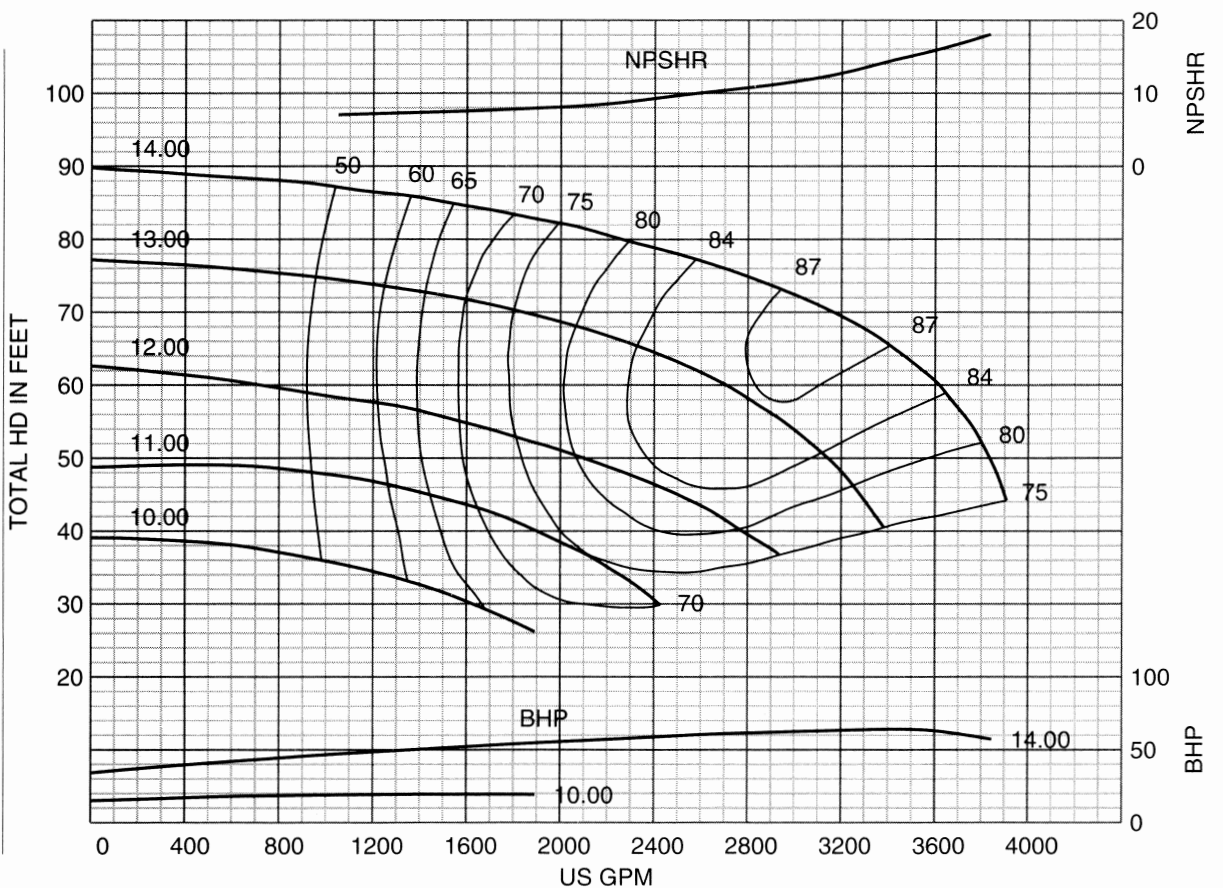



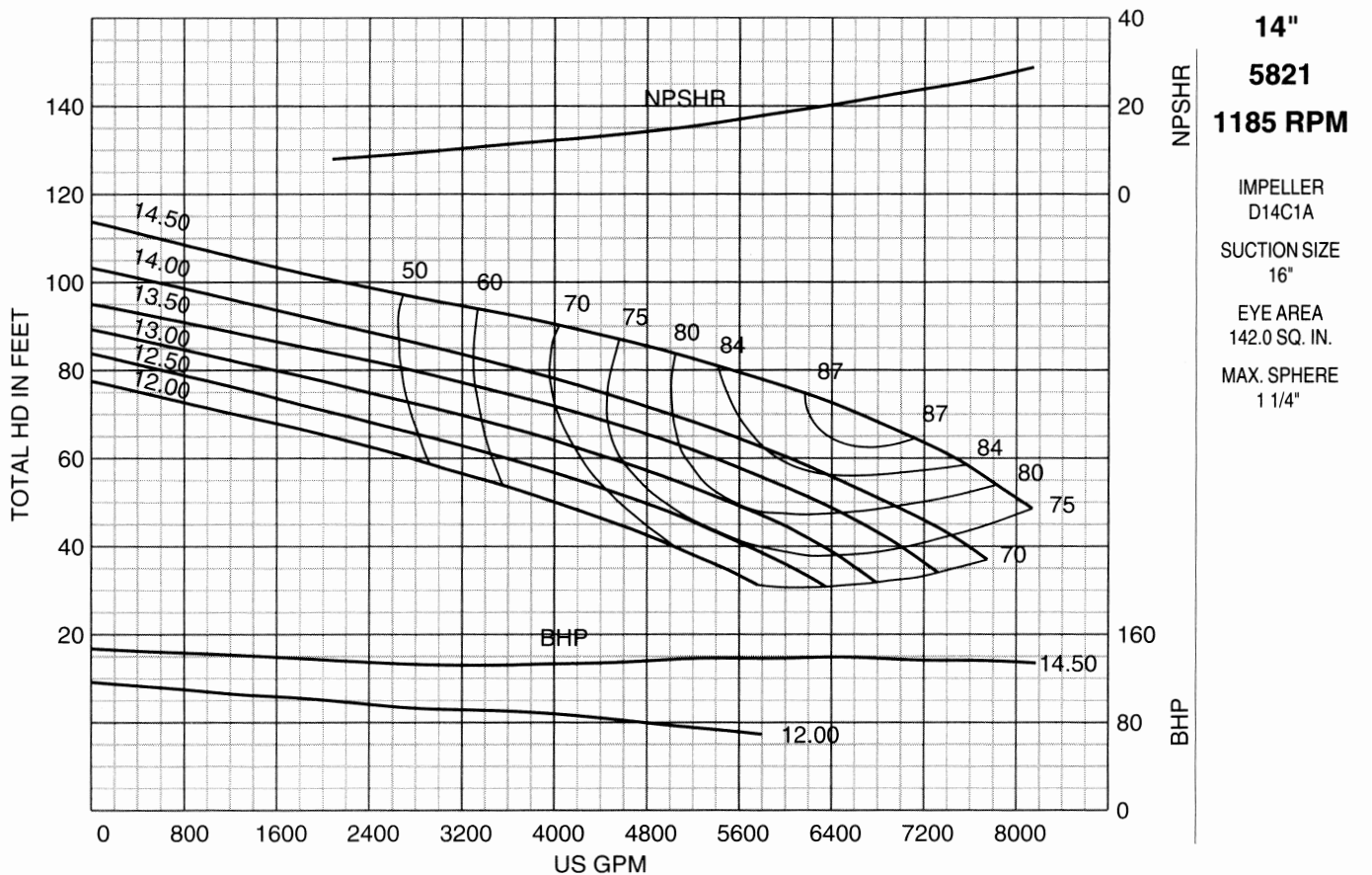
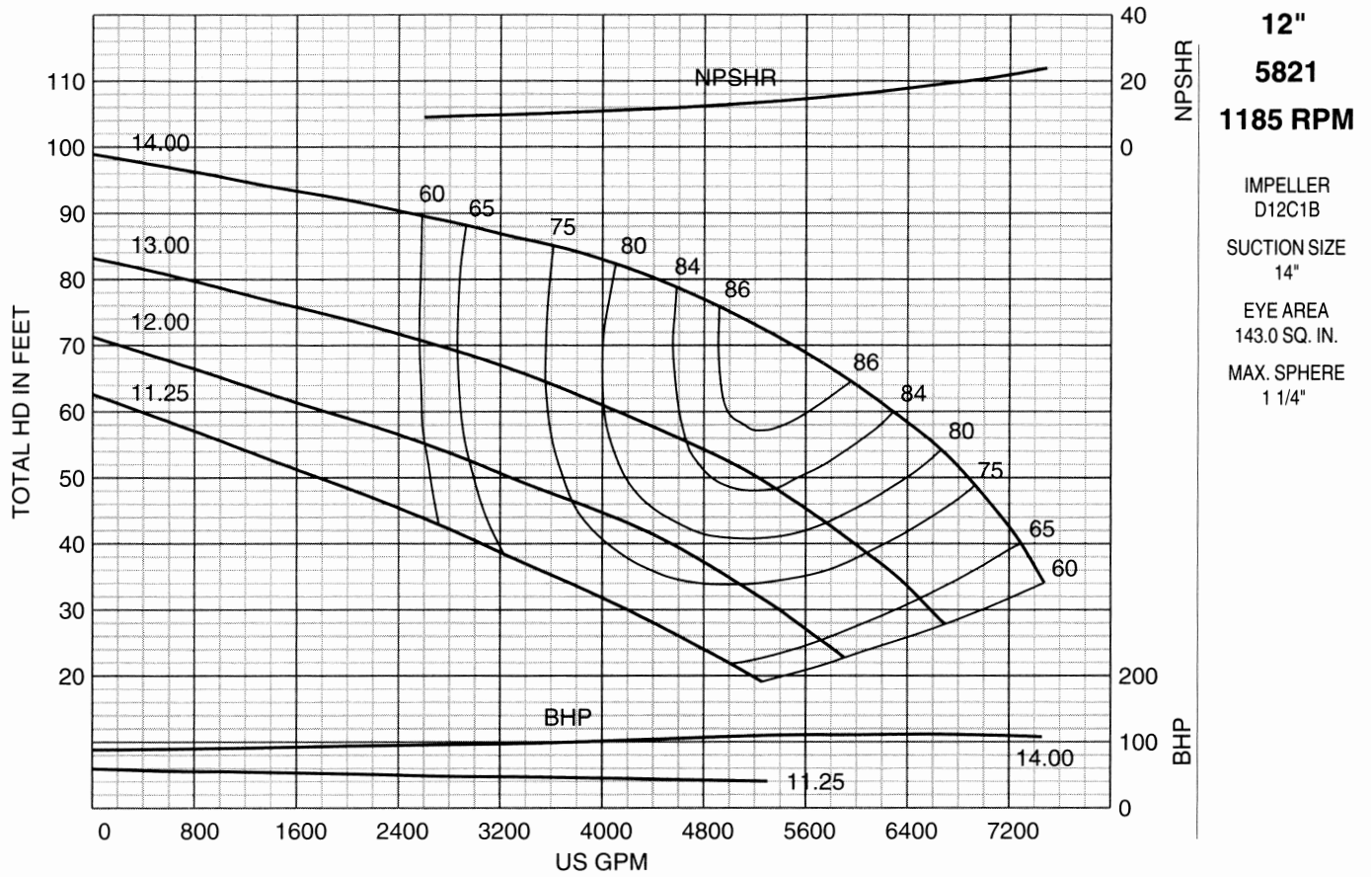

**4"**  
**5822**  
**1170 RPM**

IMPELLER  
D4B1C  
SUCTION SIZE  
5"  
EYE AREA  
18.8 SQ. IN.  
MAX. SPHERE  
1/2"

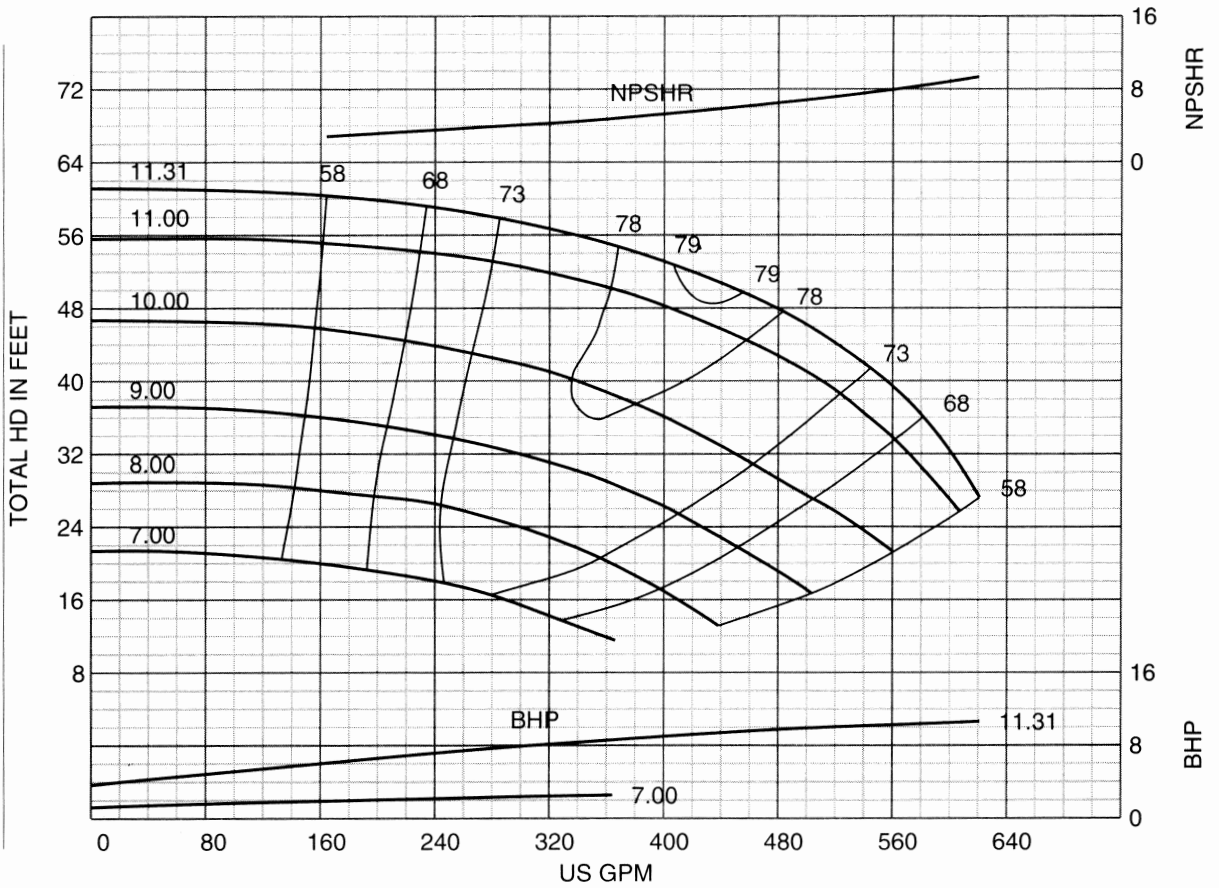

**5"**  
**5822**  
**1170 RPM**

IMPELLER  
D5B1K  
SUCTION SIZE  
6"  
EYE AREA  
26.2 SQ. IN.  
MAX. SPHERE  
5/8"

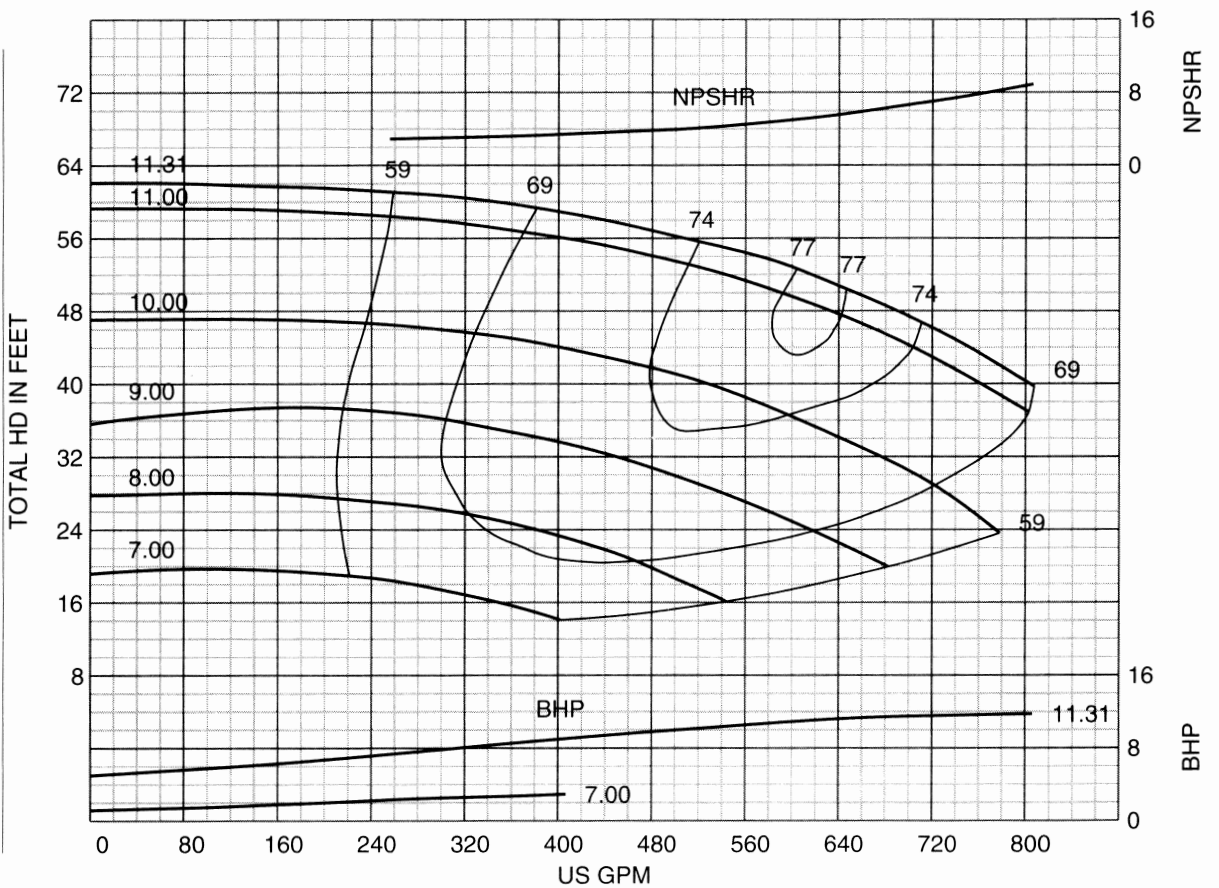



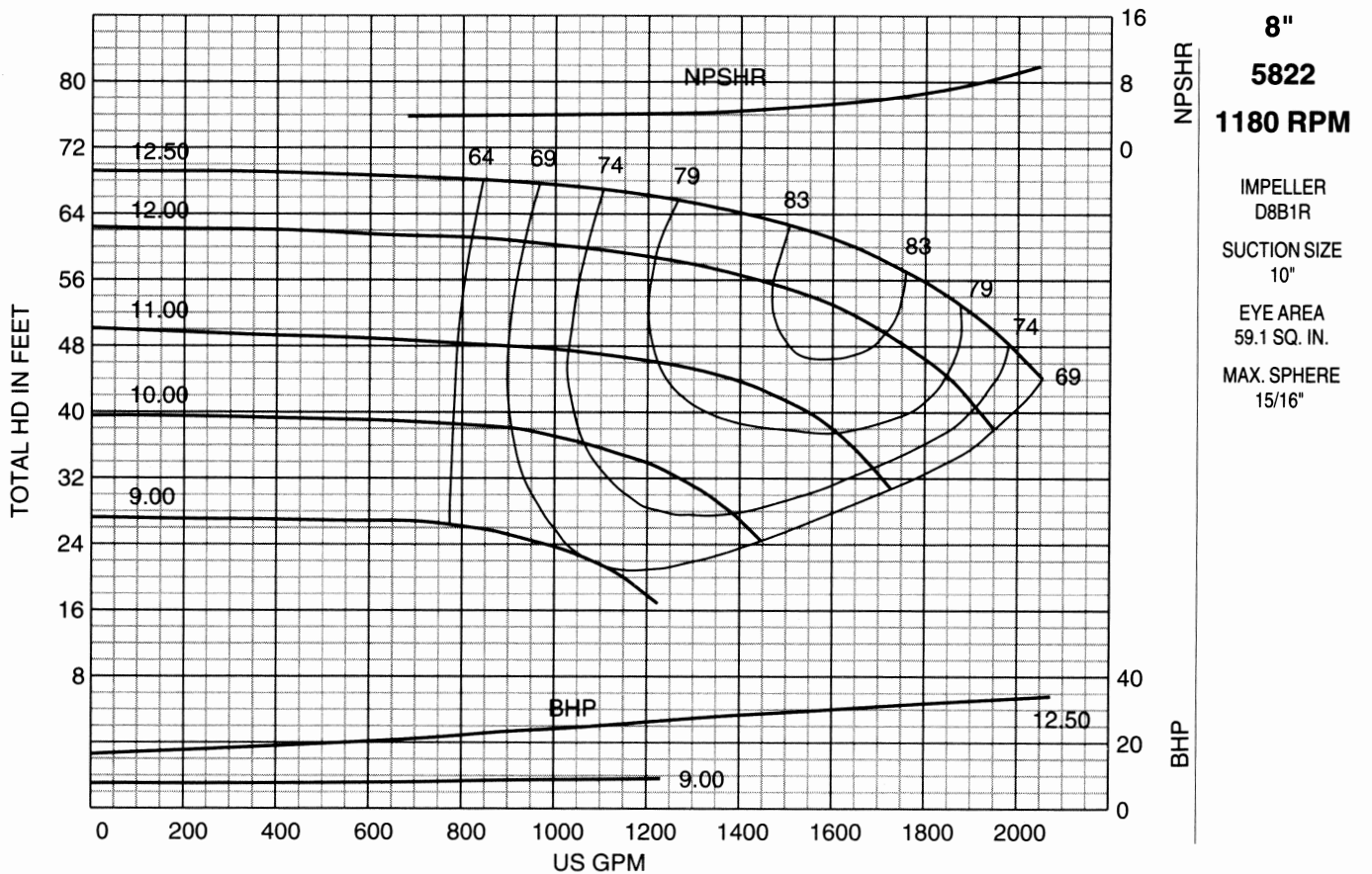
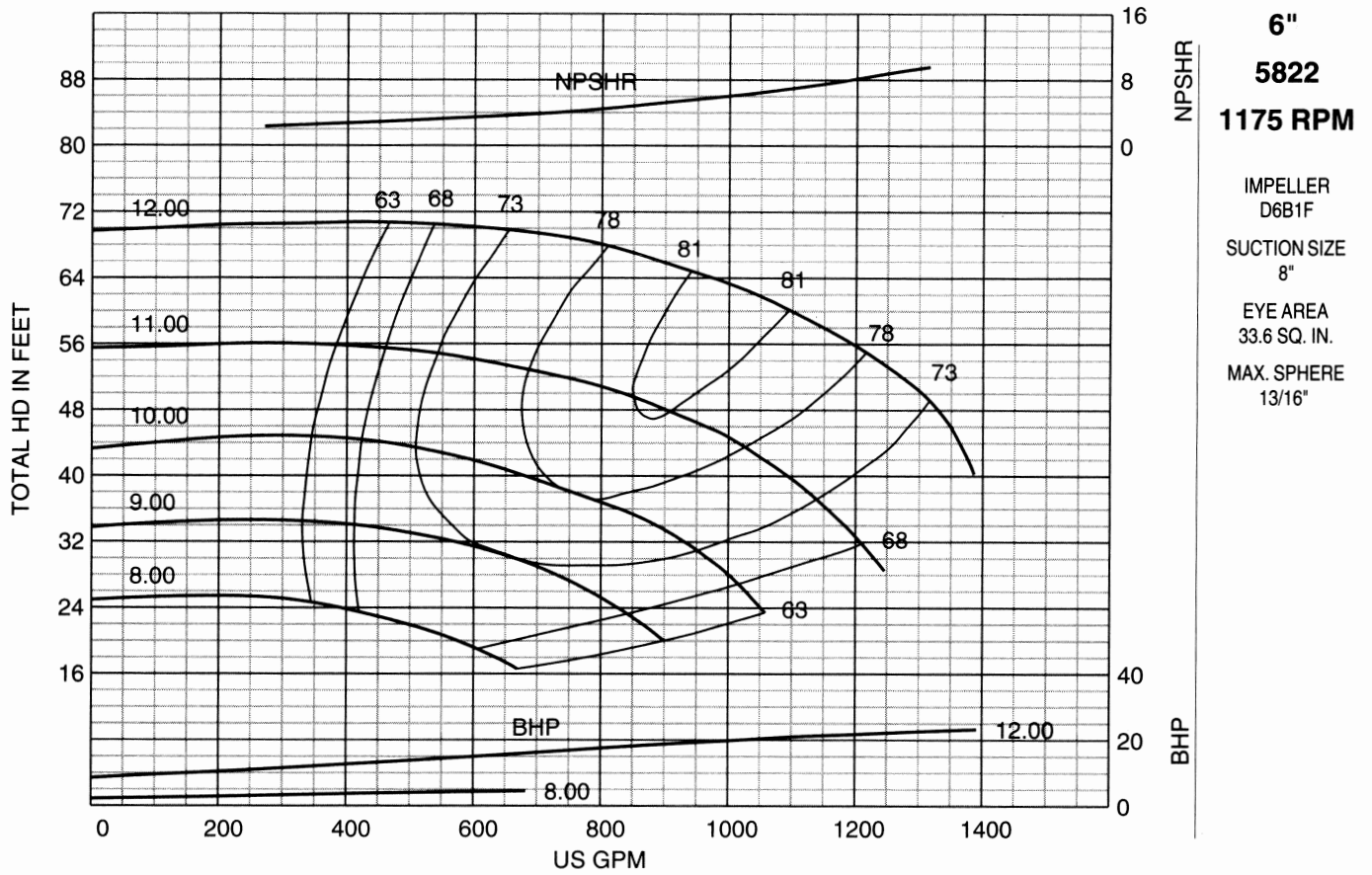

**12"**  
**5822**  
**1185 RPM**

IMPELLER  
 D12B1A  
 SUCTION SIZE  
 14"  
 EYE AREA  
 107.0 SQ. IN.  
 MAX. SPHERE  
 1"

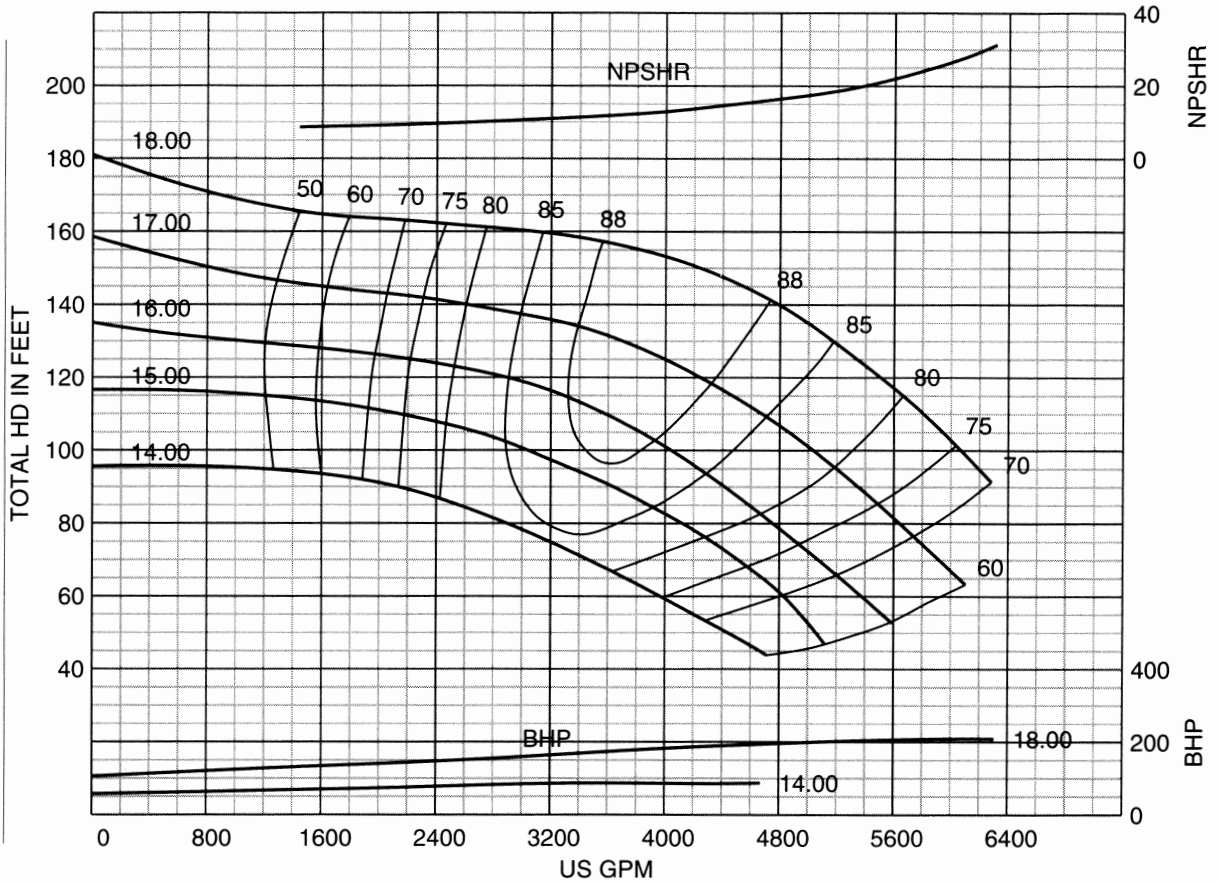

**4"**  
**5823**  
**1175 RPM**

IMPELLER  
 D4A1C  
 SUCTION SIZE  
 5"  
 EYE AREA  
 24.4 SQ. IN.  
 MAX. SPHERE  
 7/16"

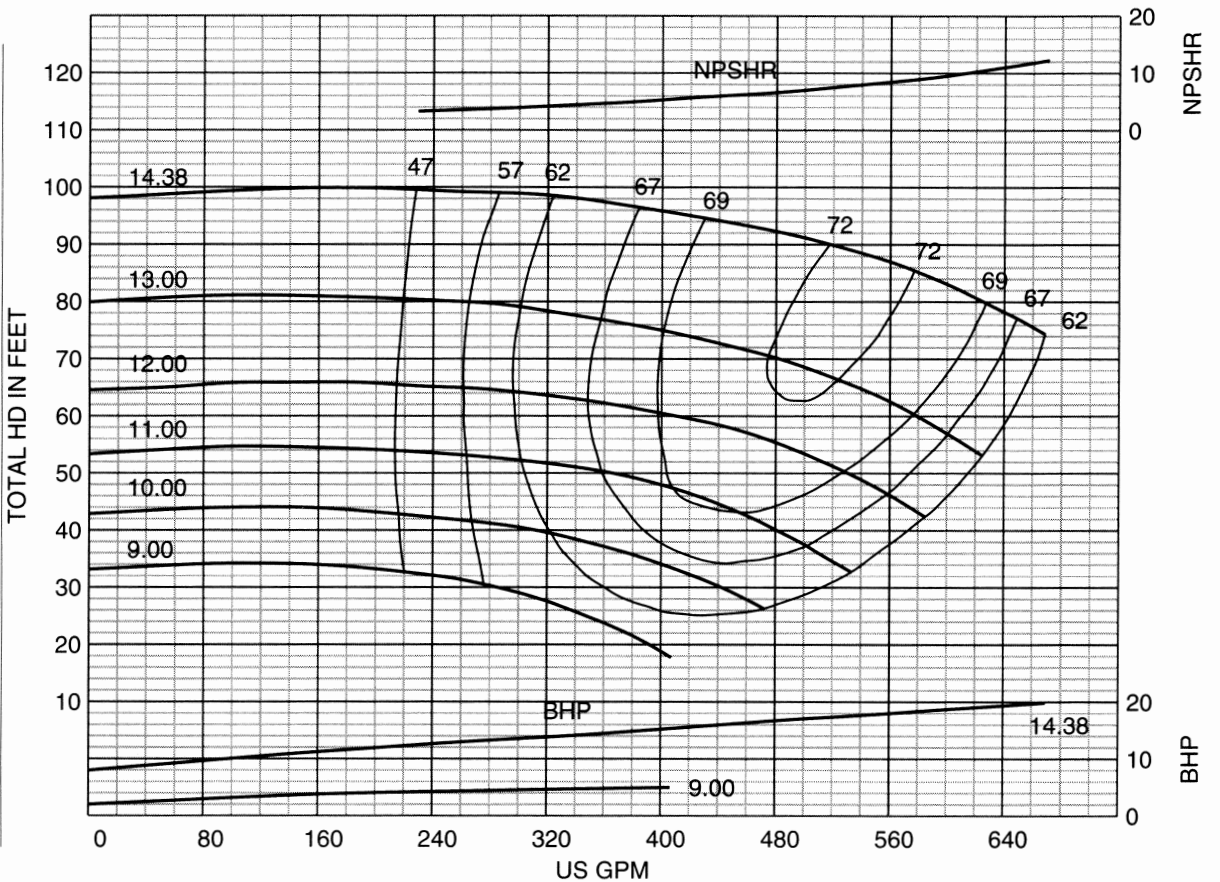



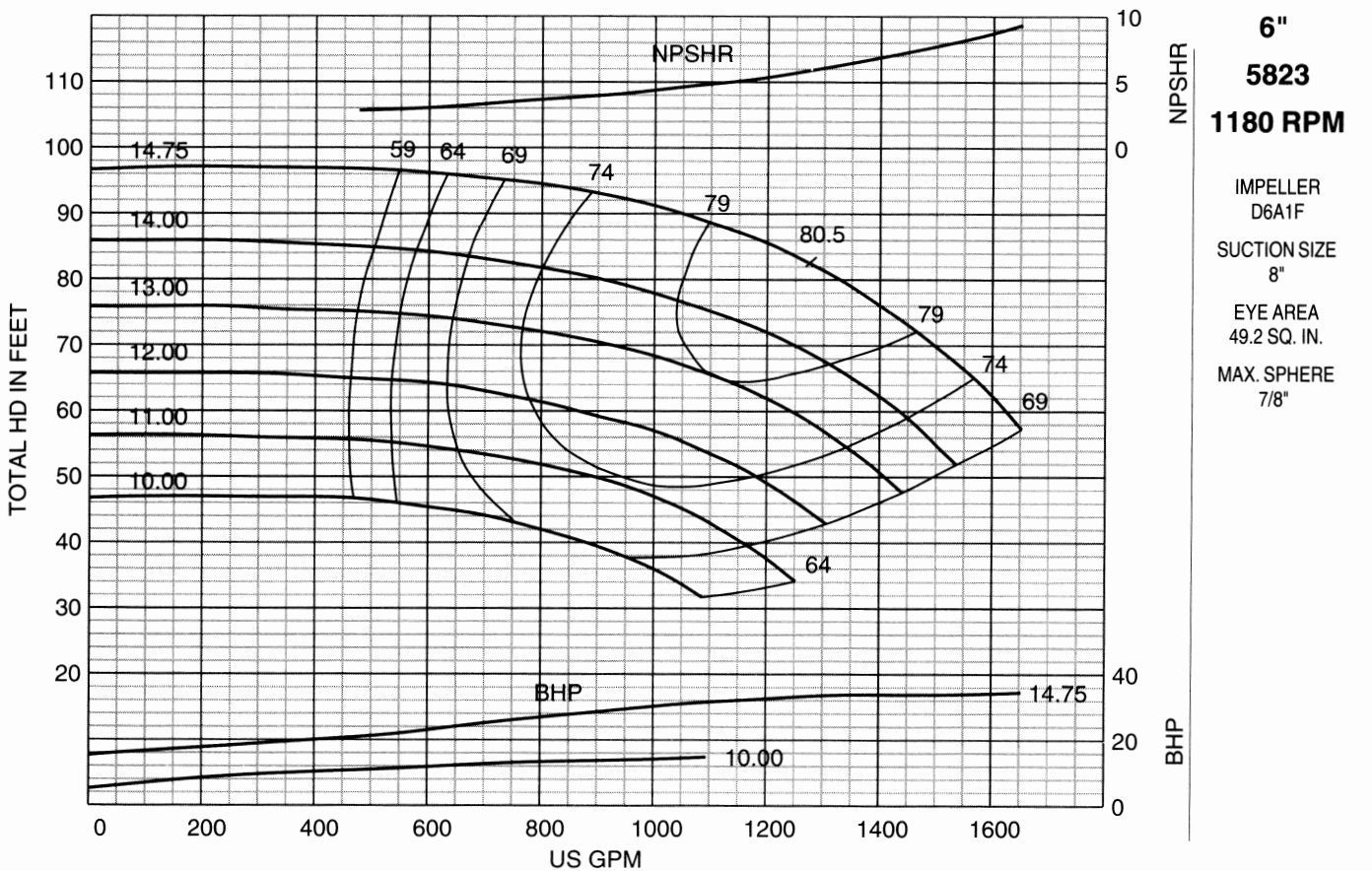
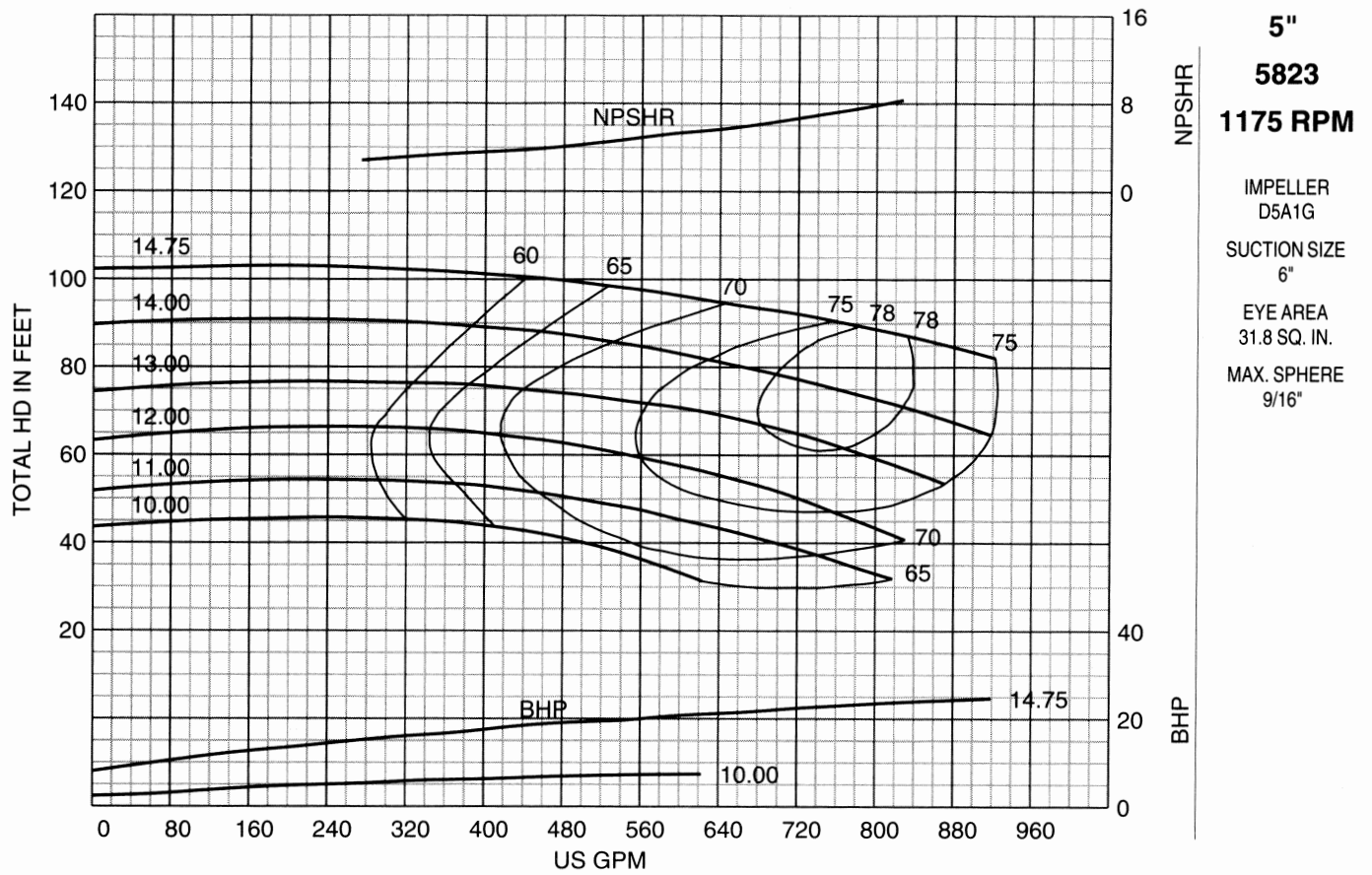

**8"**  
**5823**  
**1185 RPM**

IMPELLER  
 D8A1F  
 SUCTION SIZE  
 10"  
 EYE AREA  
 64.4 SQ. IN.  
 MAX. SPHERE  
 15/16"

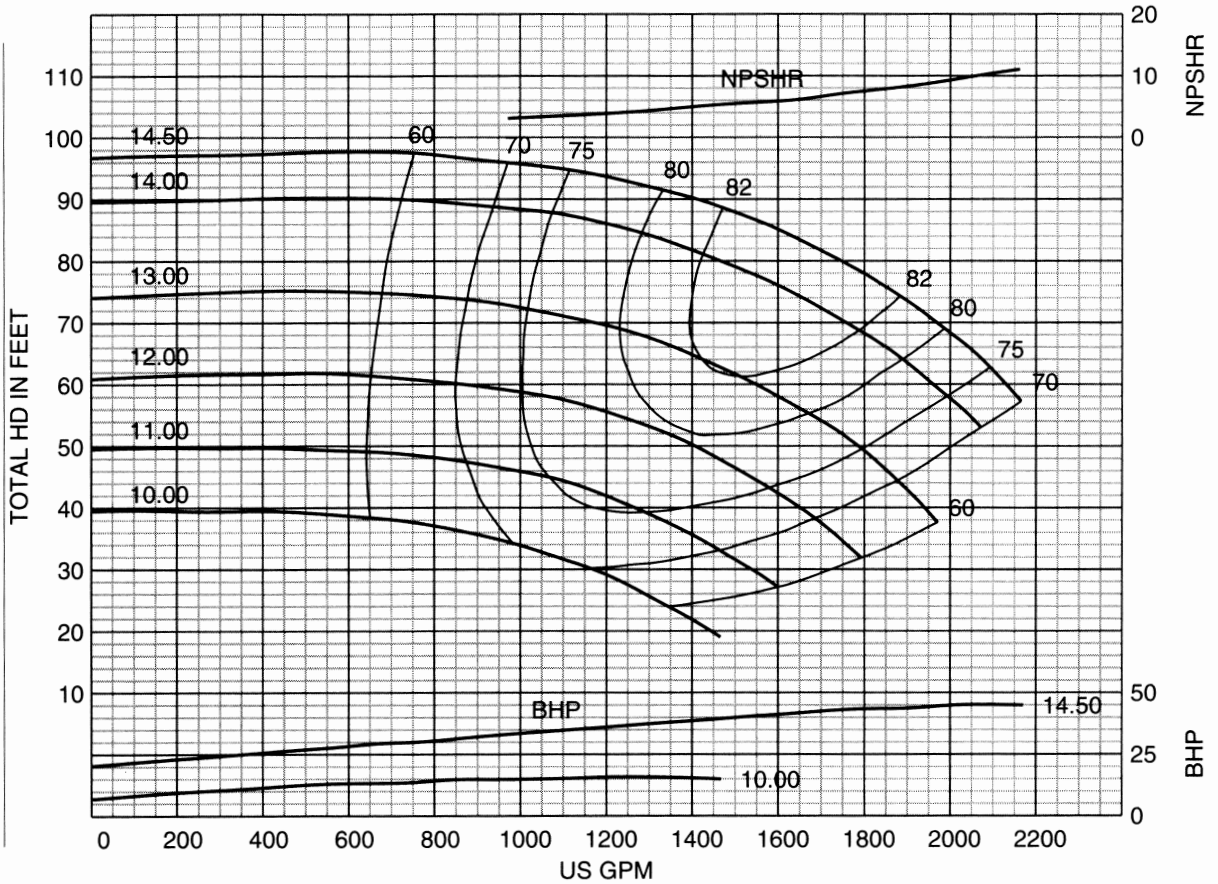

**10"**  
**5823**  
**1185 RPM**

IMPELLER  
 D10A1A  
 SUCTION SIZE  
 12"  
 EYE AREA  
 89.4 SQ. IN.  
 MAX. SPHERE  
 7/8"

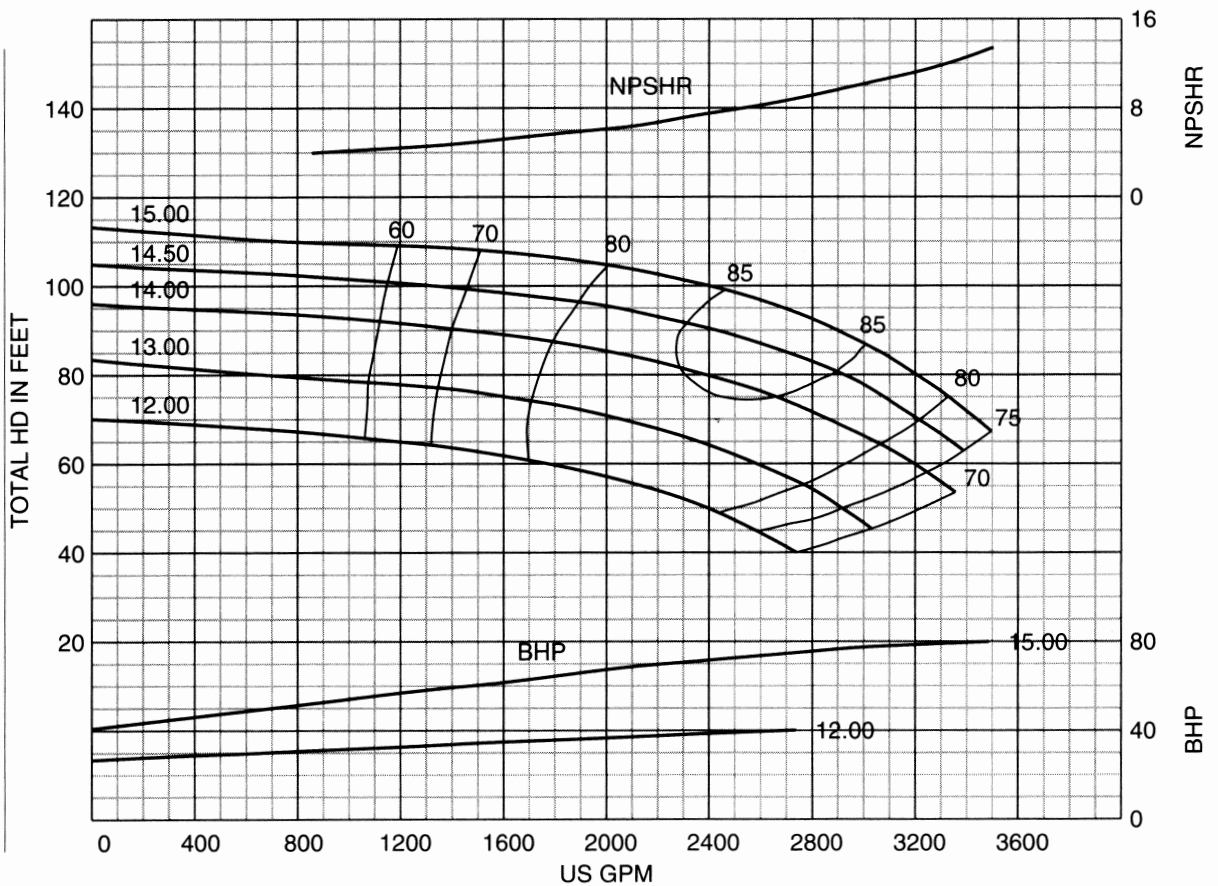



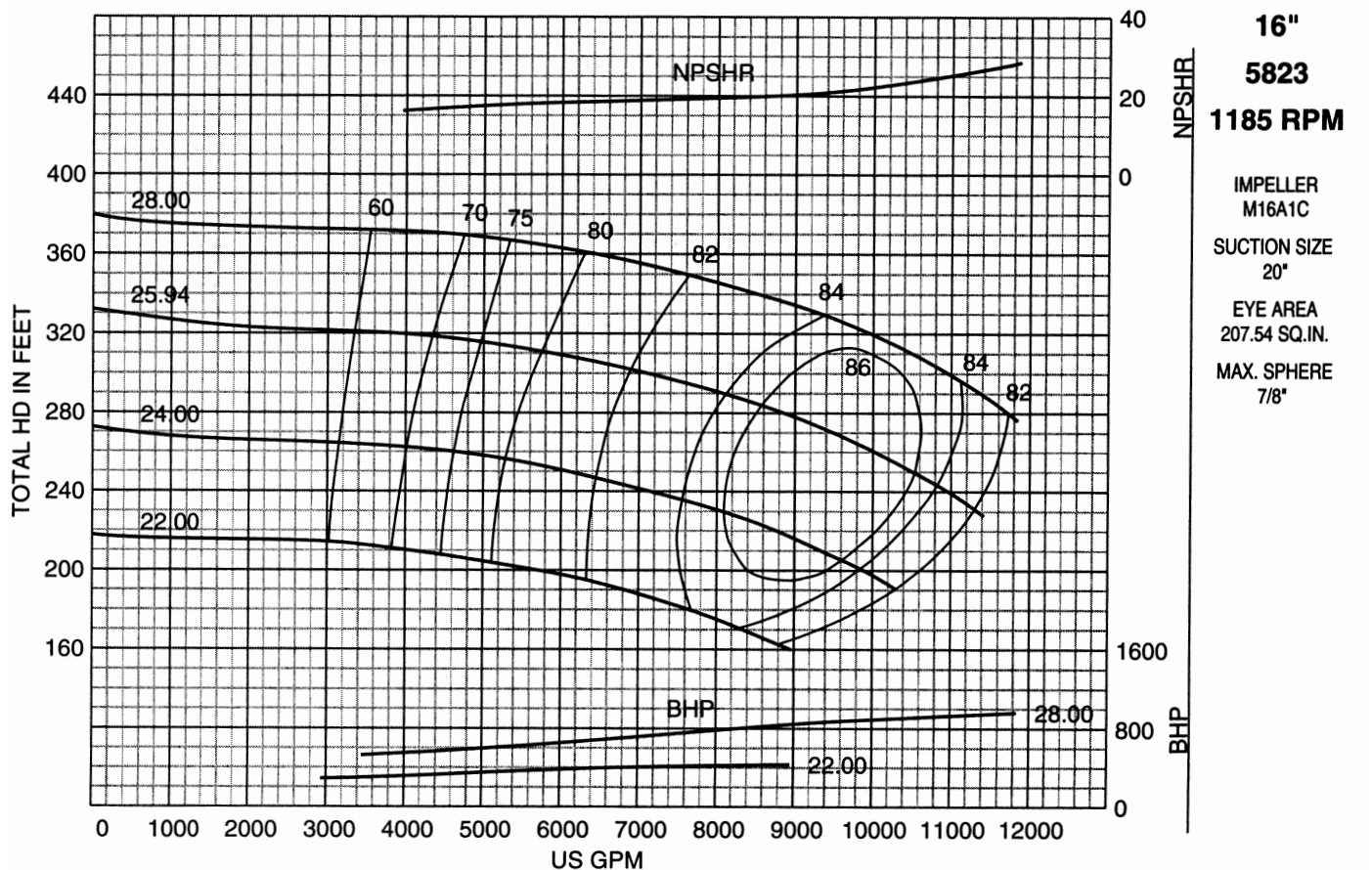
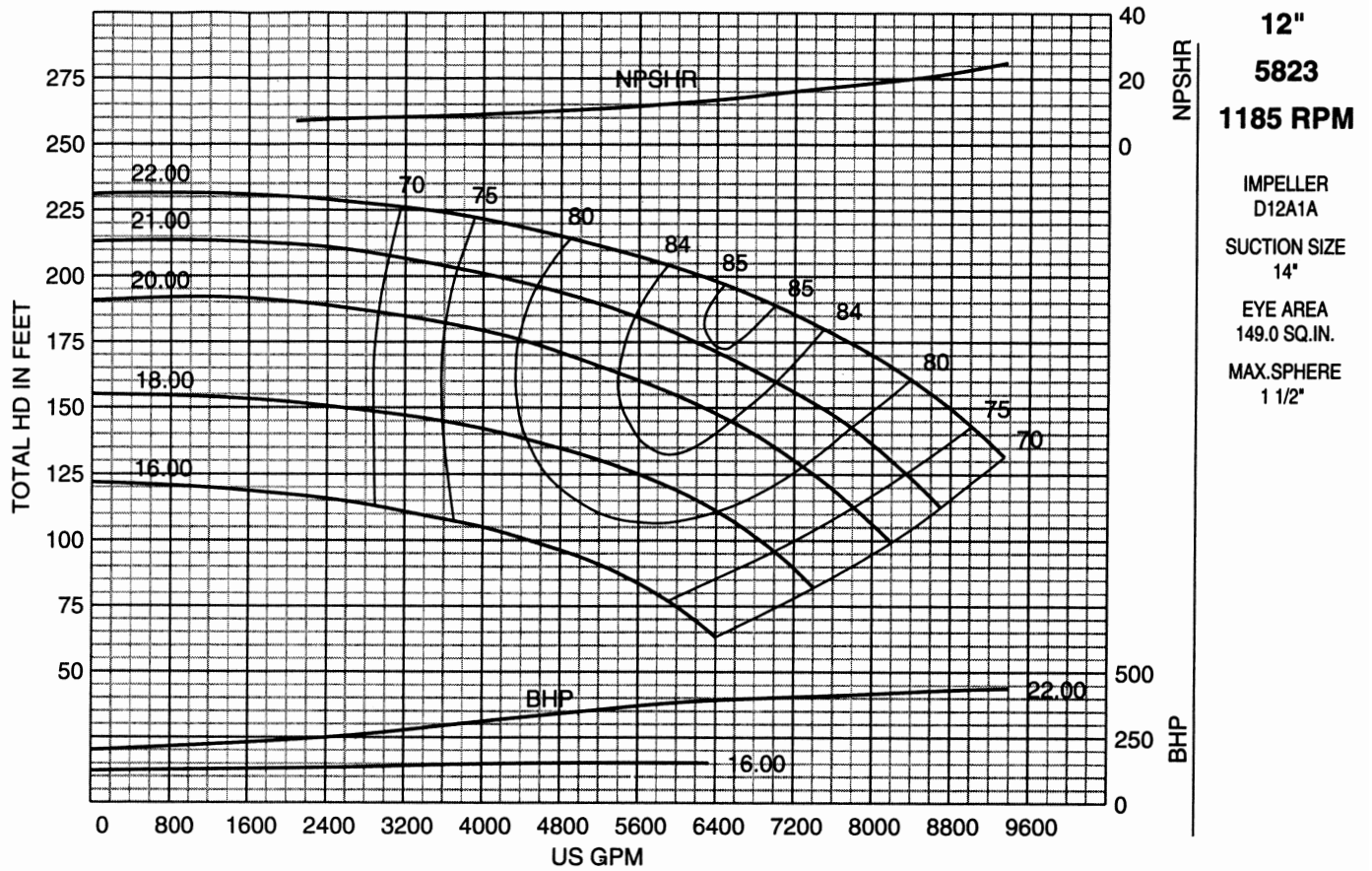

**16"**  
**5823**

**1185 RPM**

IMPELLER  
M16A1L

SUCTION SIZE  
20"

EYE AREA  
208 SQ. IN.

MAX SPHERE  
1"

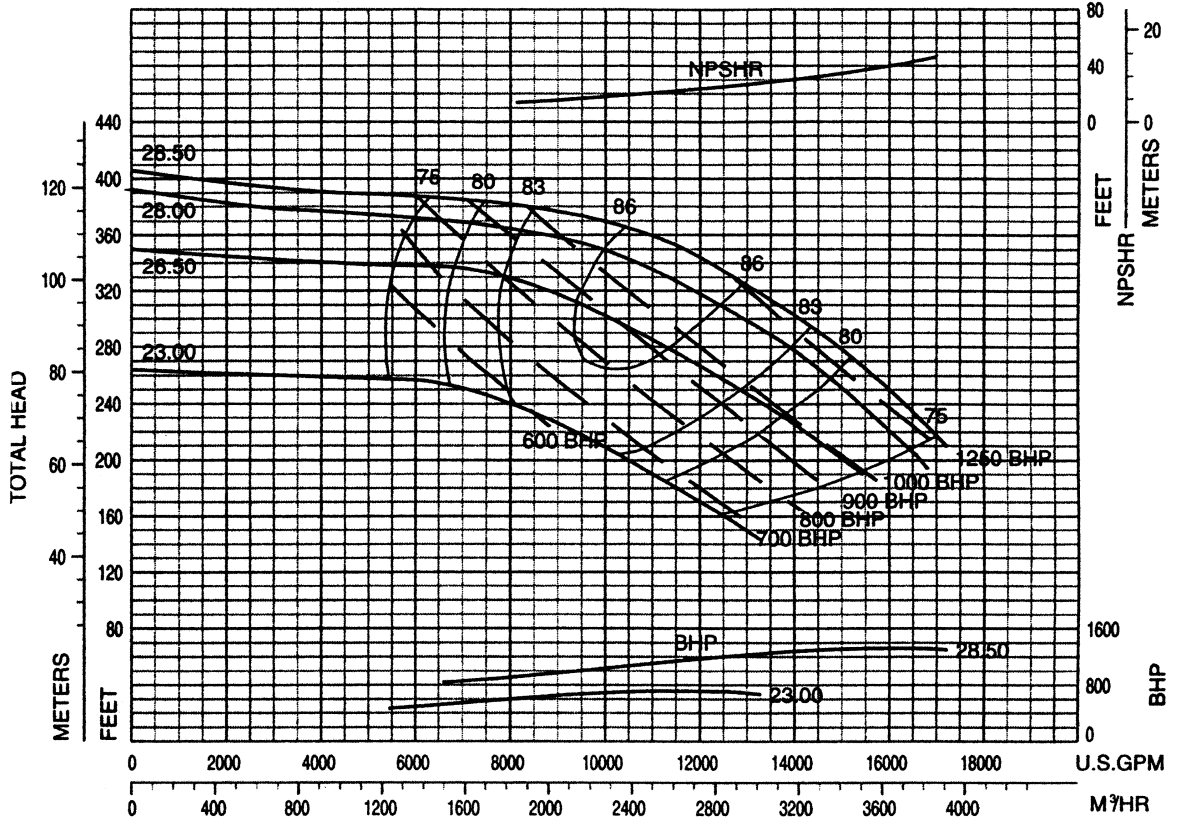

**18"**  
**5823**

**1180 RPM**

IMPELLER  
D18A1B

SUCTION SIZE  
24"

EYE AREA  
330 SQ. IN.

MAX SPHERE  
1.7"

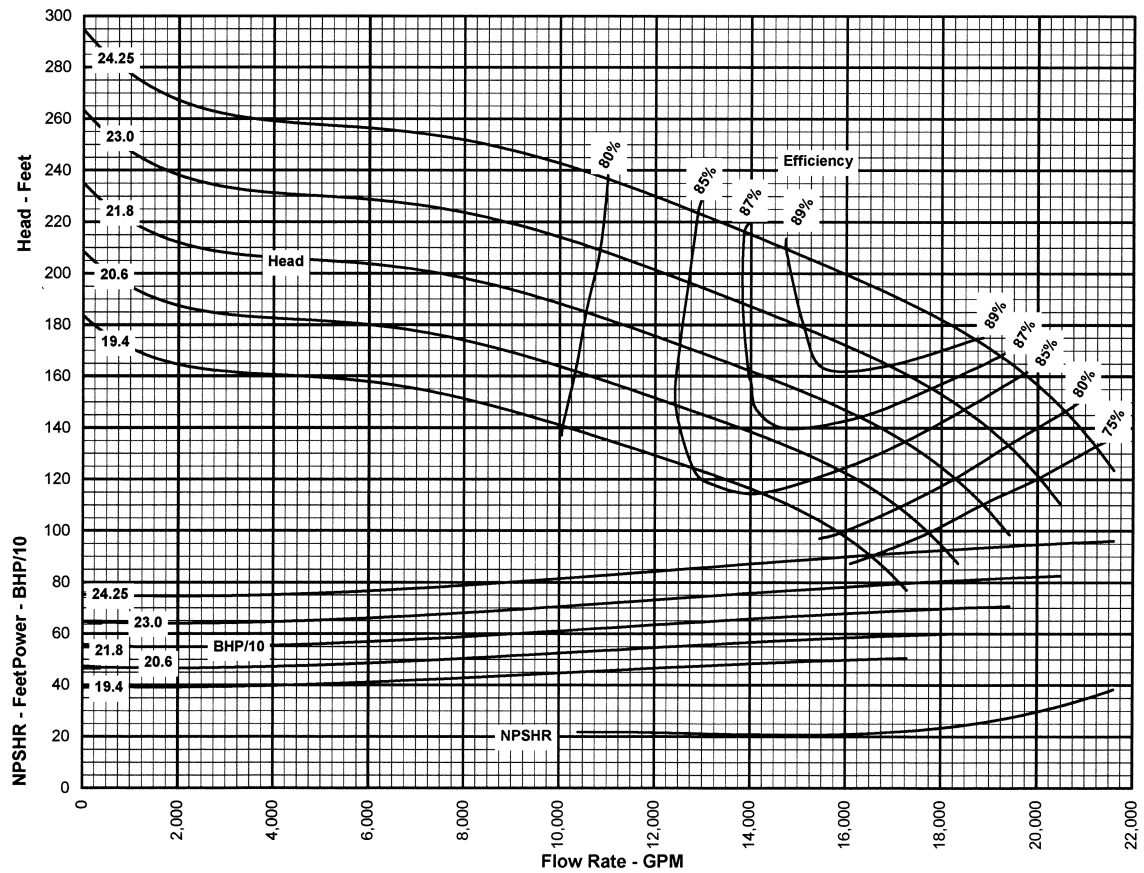



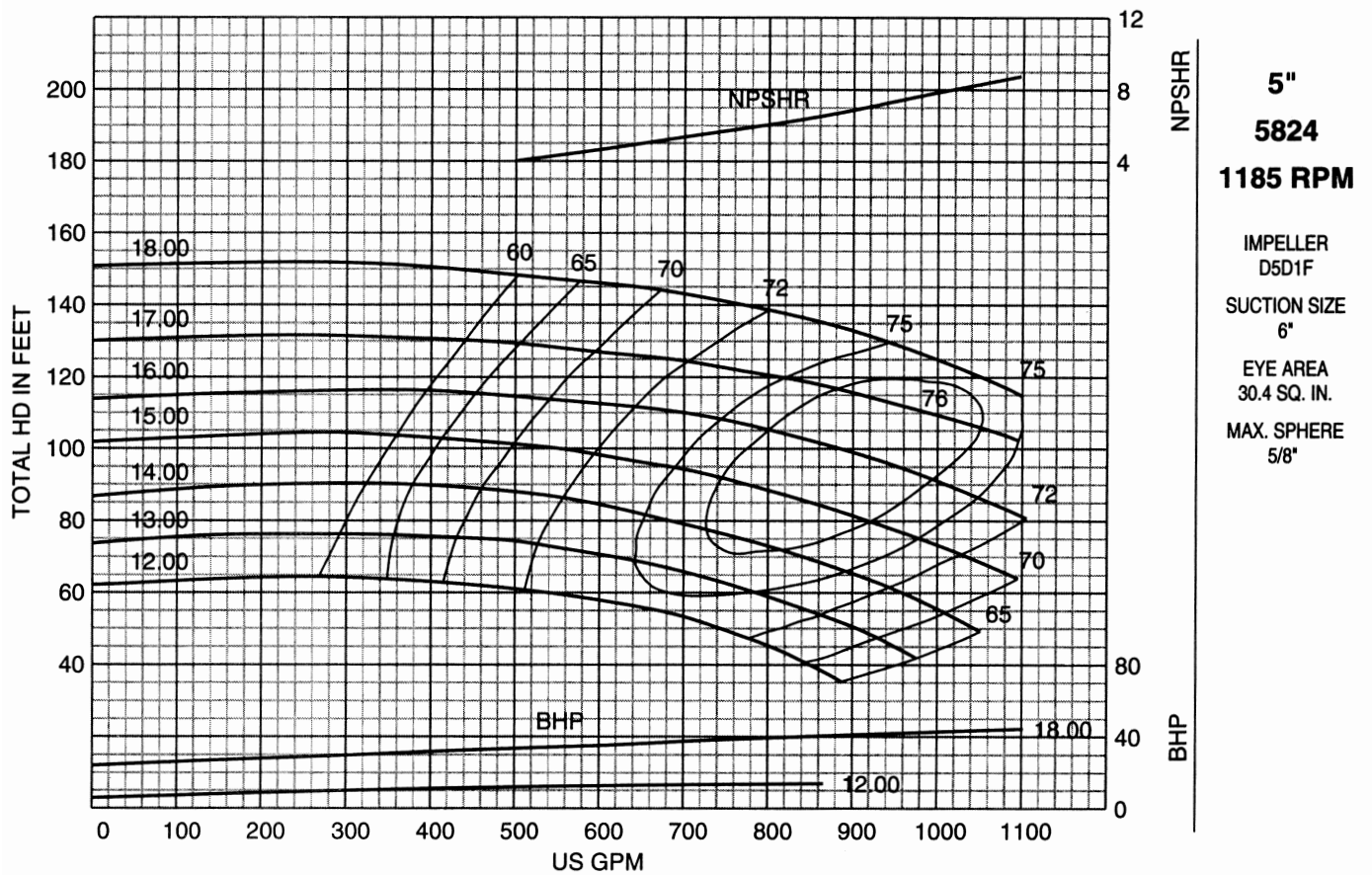
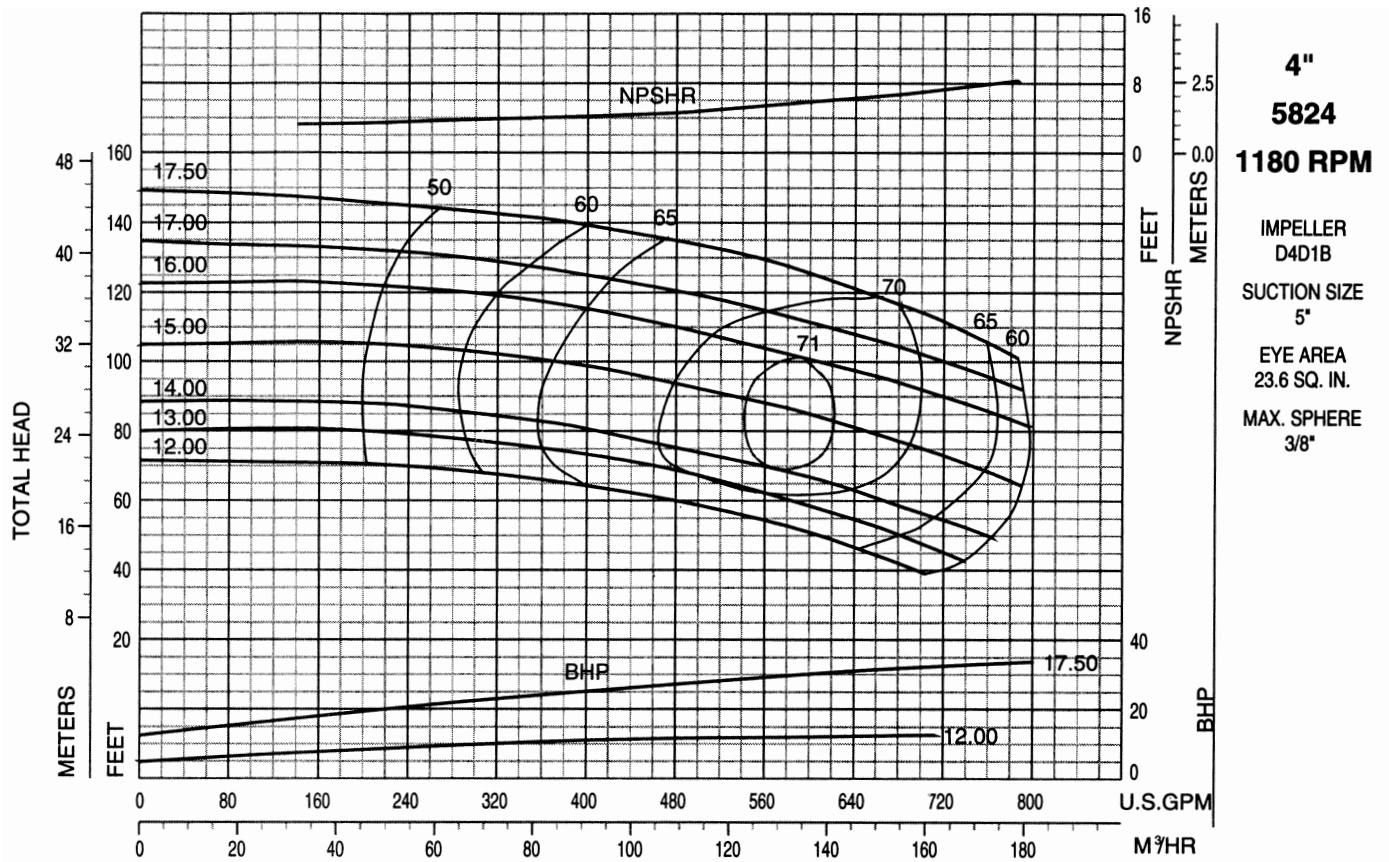

 Notes:



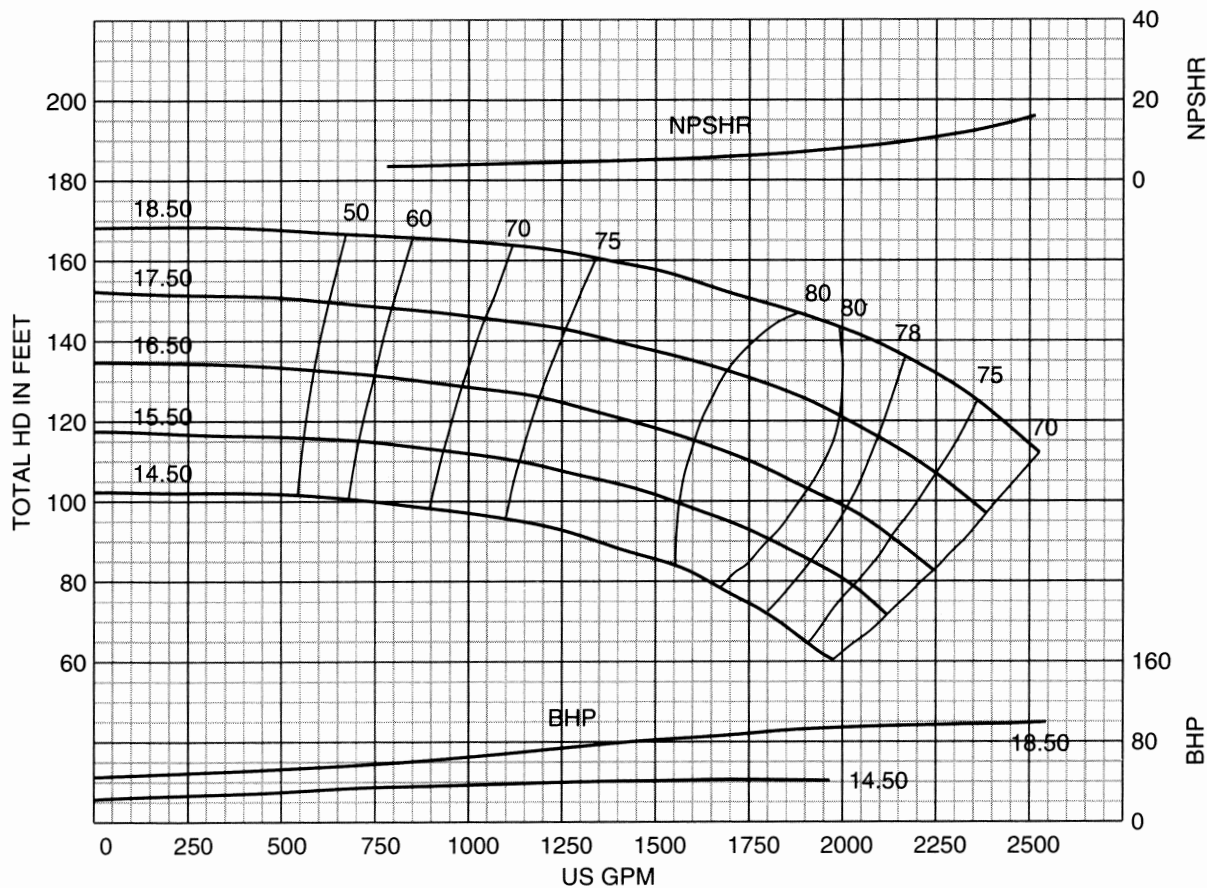
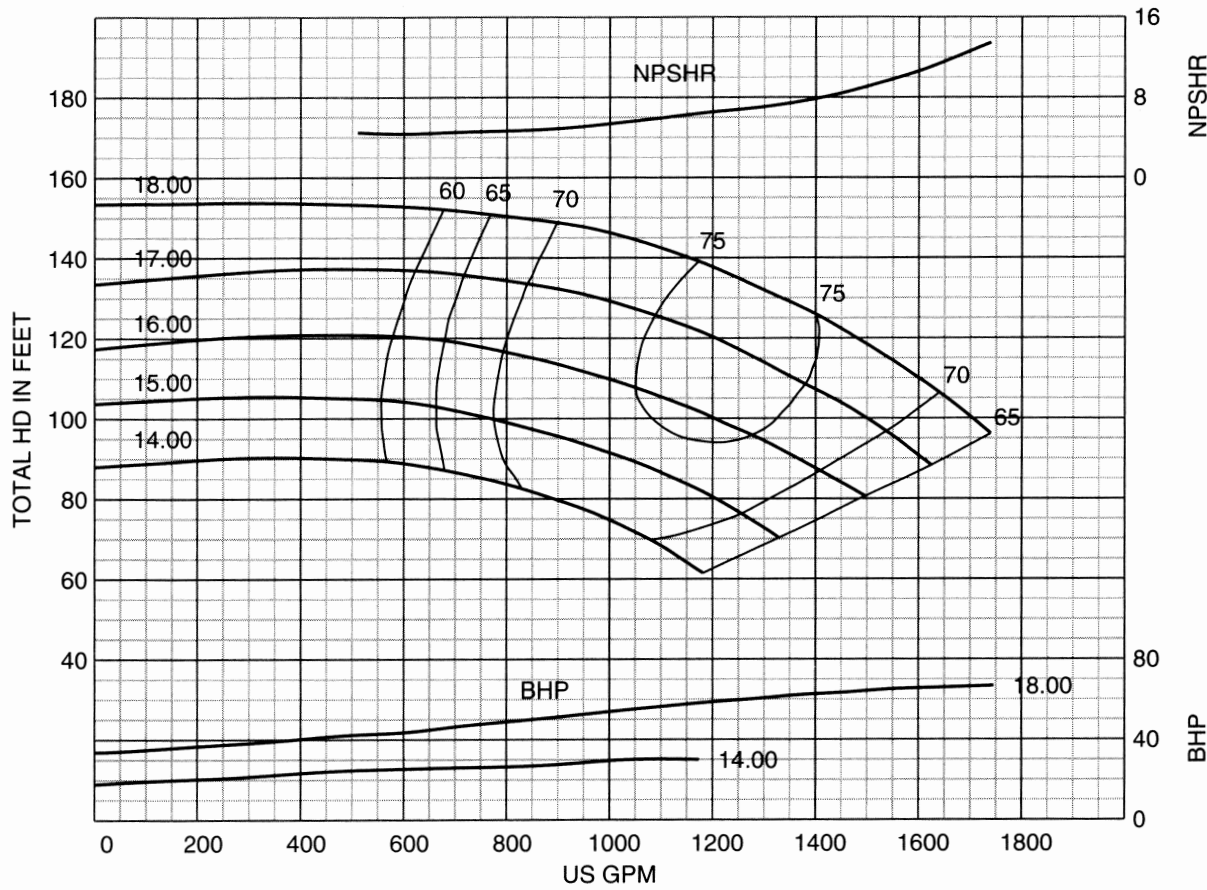

**10"**  
**5824**  
**1185 RPM**

IMPELLER  
D10D1W  
SUCTION SIZE  
12"  
EYE AREA  
99.4 SQ. IN.  
MAX. SPHERE  
15/16"

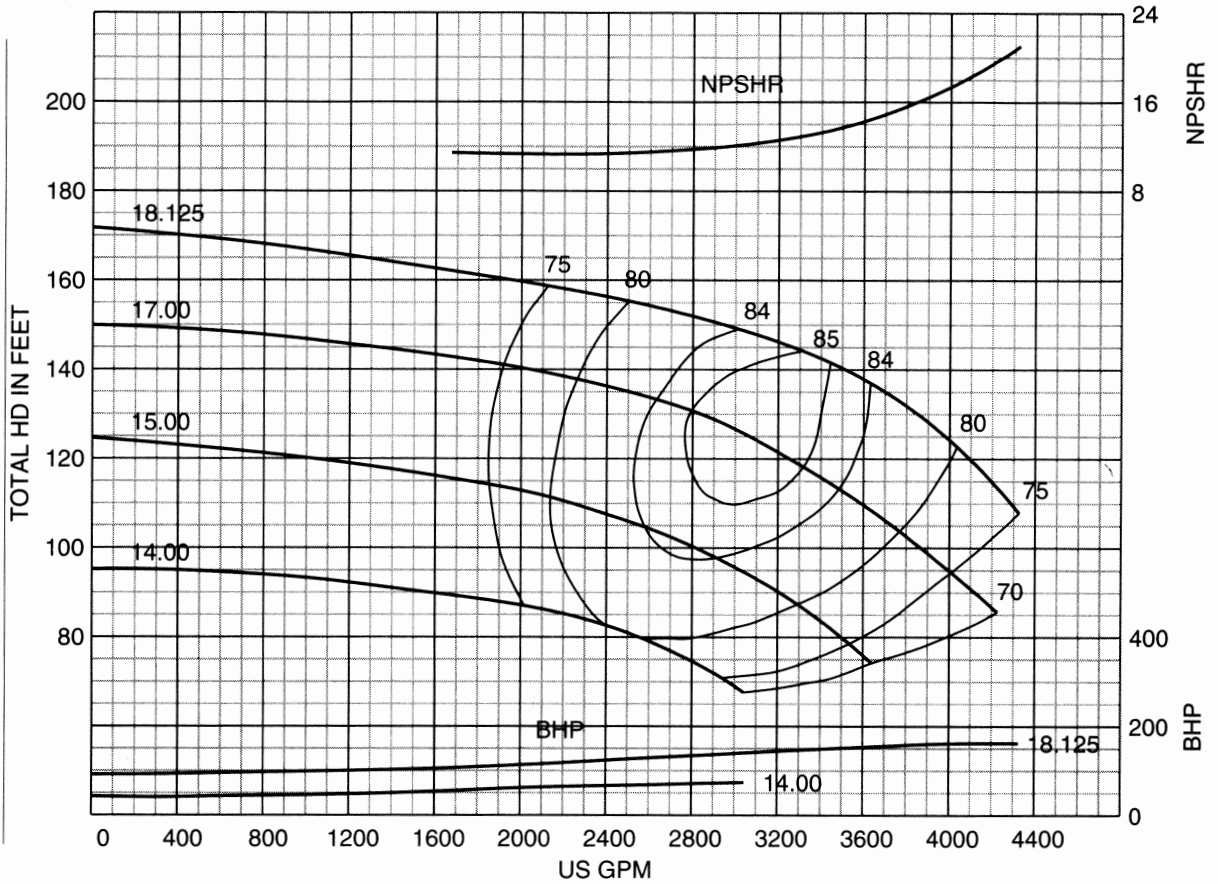

**10"**  
**5825**  
**1185 RPM**

IMPELLER  
D10E1A  
SUCTION SIZE  
14"  
EYE AREA  
151.0 SQ. IN.  
MAX. SPHERE  
17/16"

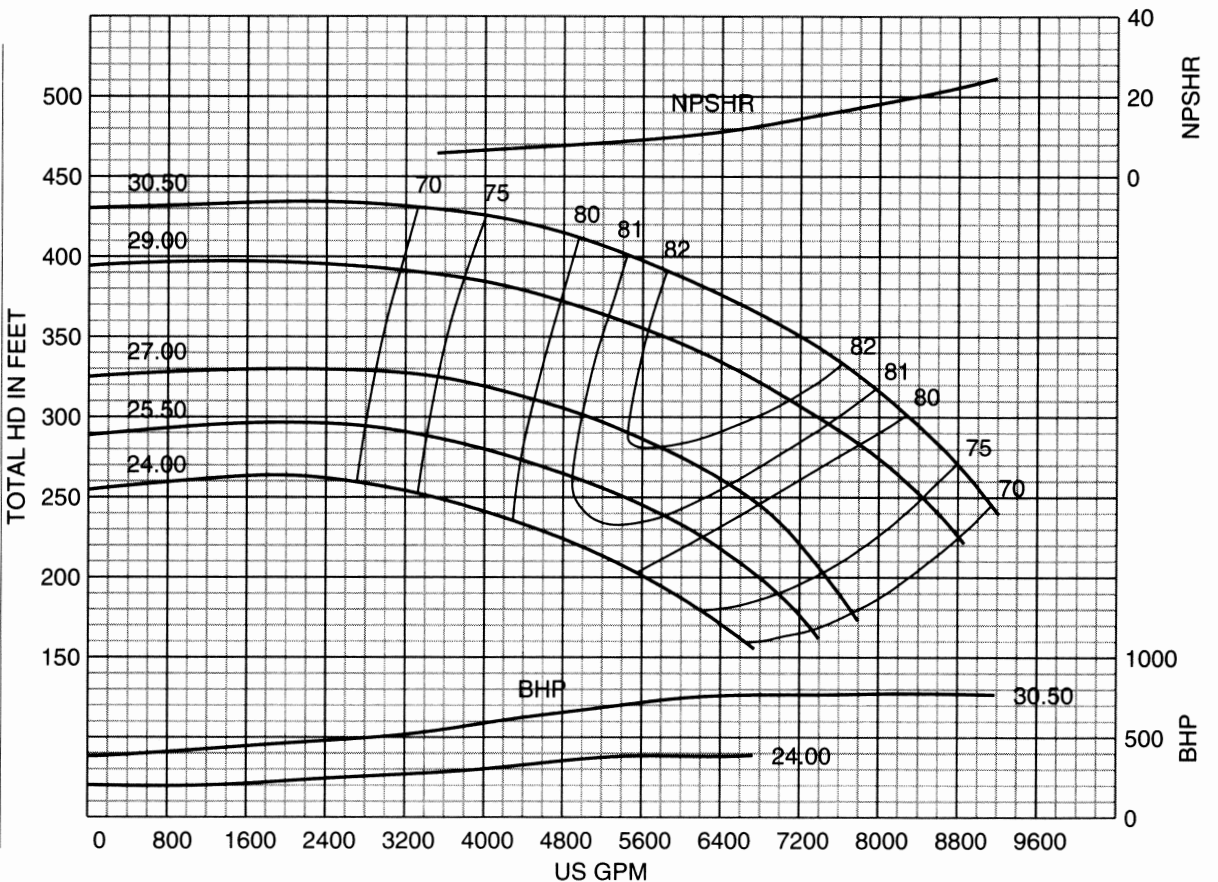



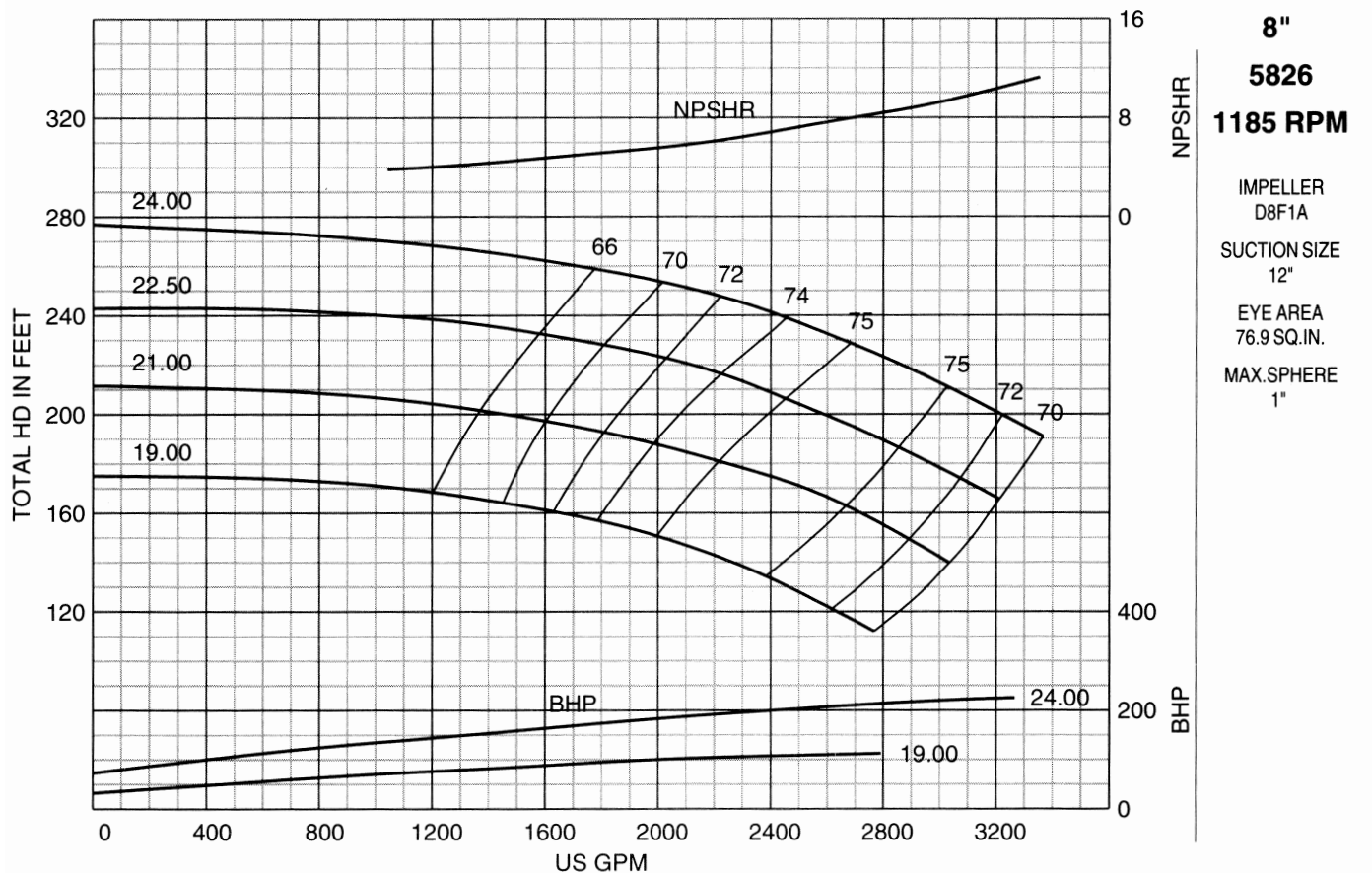
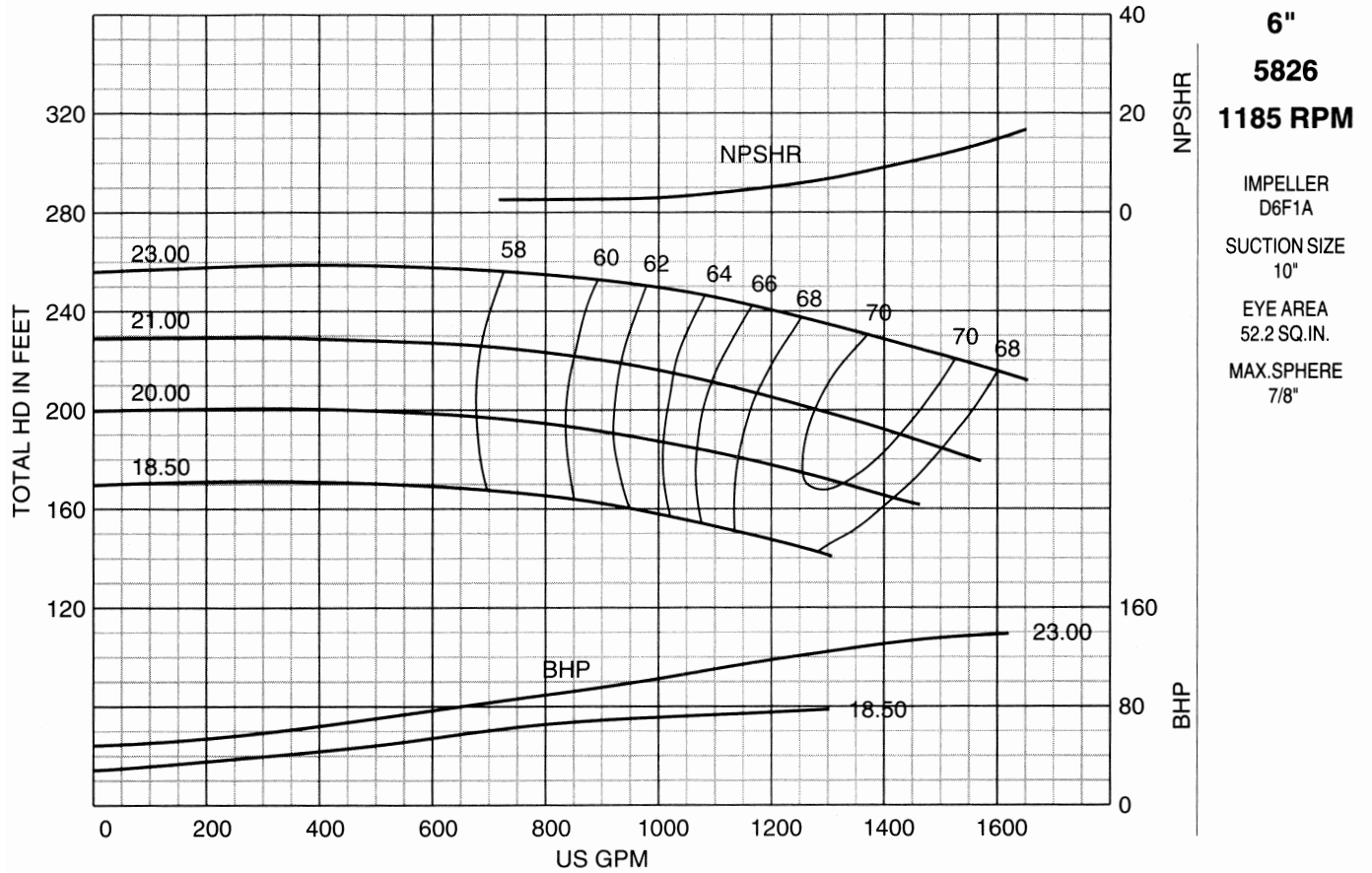

**10"**  
**5826**  
**1185 RPM**

IMPELLER  
D10F1A  
SUCTION SIZE  
14"  
EYE AREA  
133.9 SQ.IN.  
MAX.SPHERE  
1 3/8"

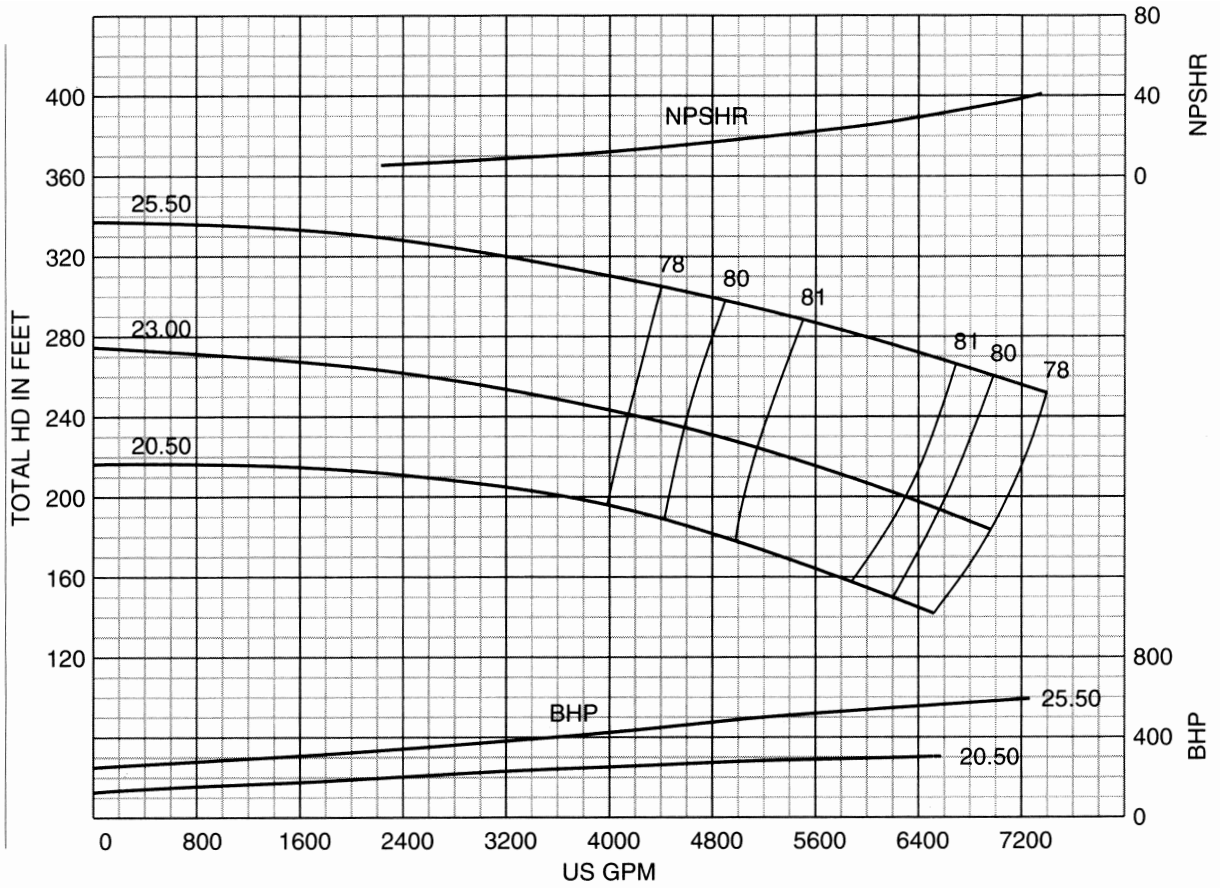



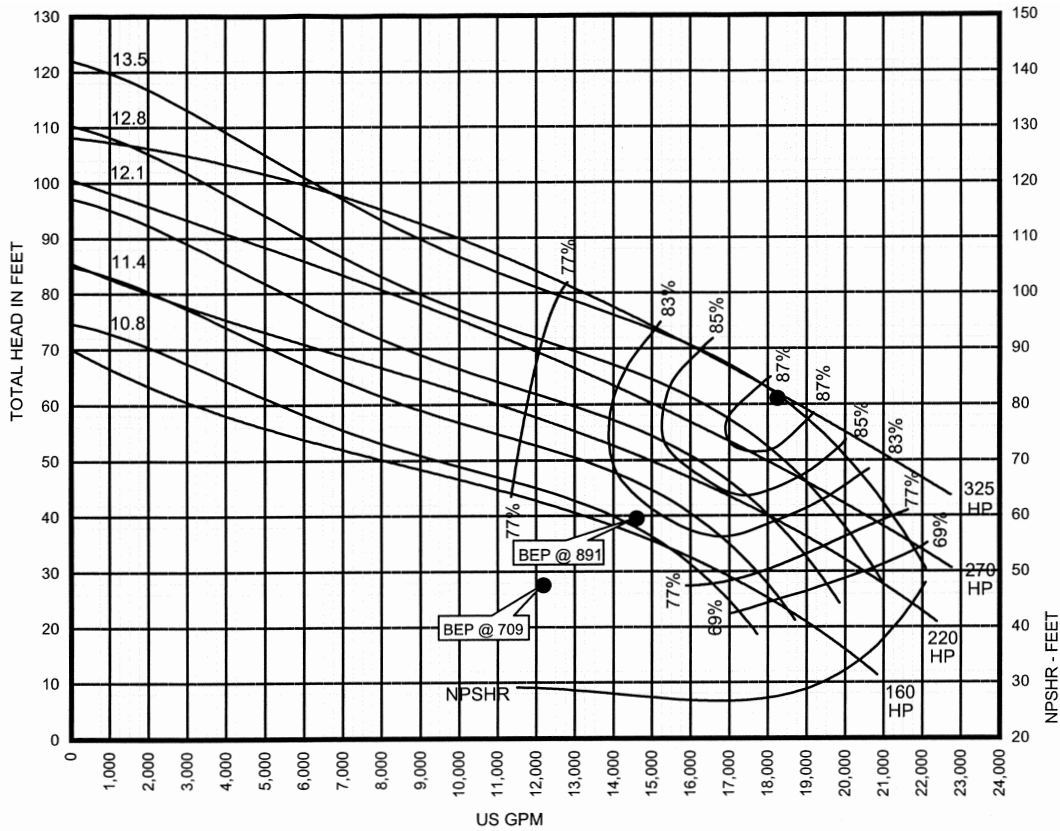

**20" 5822A**  
**1185 RPM**  
 IMPELLER D20L1A  
 SUCTION SIZE 24"  
 EYE AREA 280"  
 MAX SPHERE 1.5"

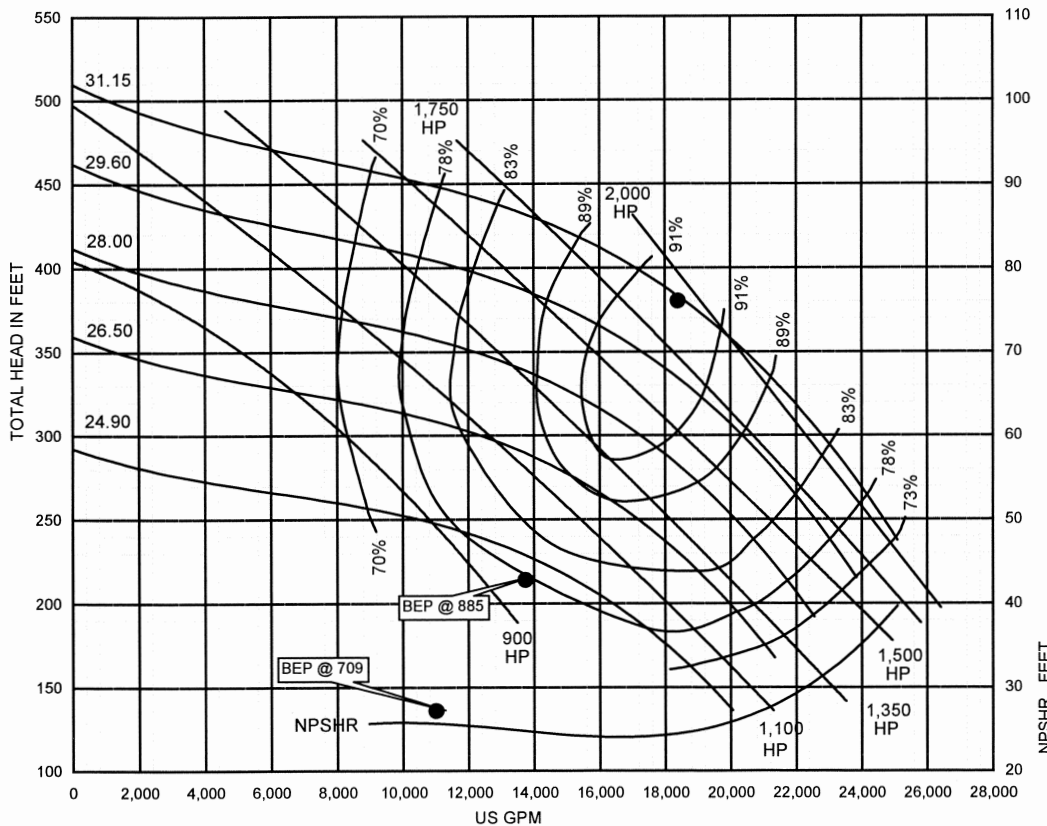

**20" 5826A**  
**1185 RPM**  
 IMPELLER D20H1A  
 SUCTION SIZE 24"  
 EYE AREA 360"  
 MAX SPHERE 3.0"

 Notes:



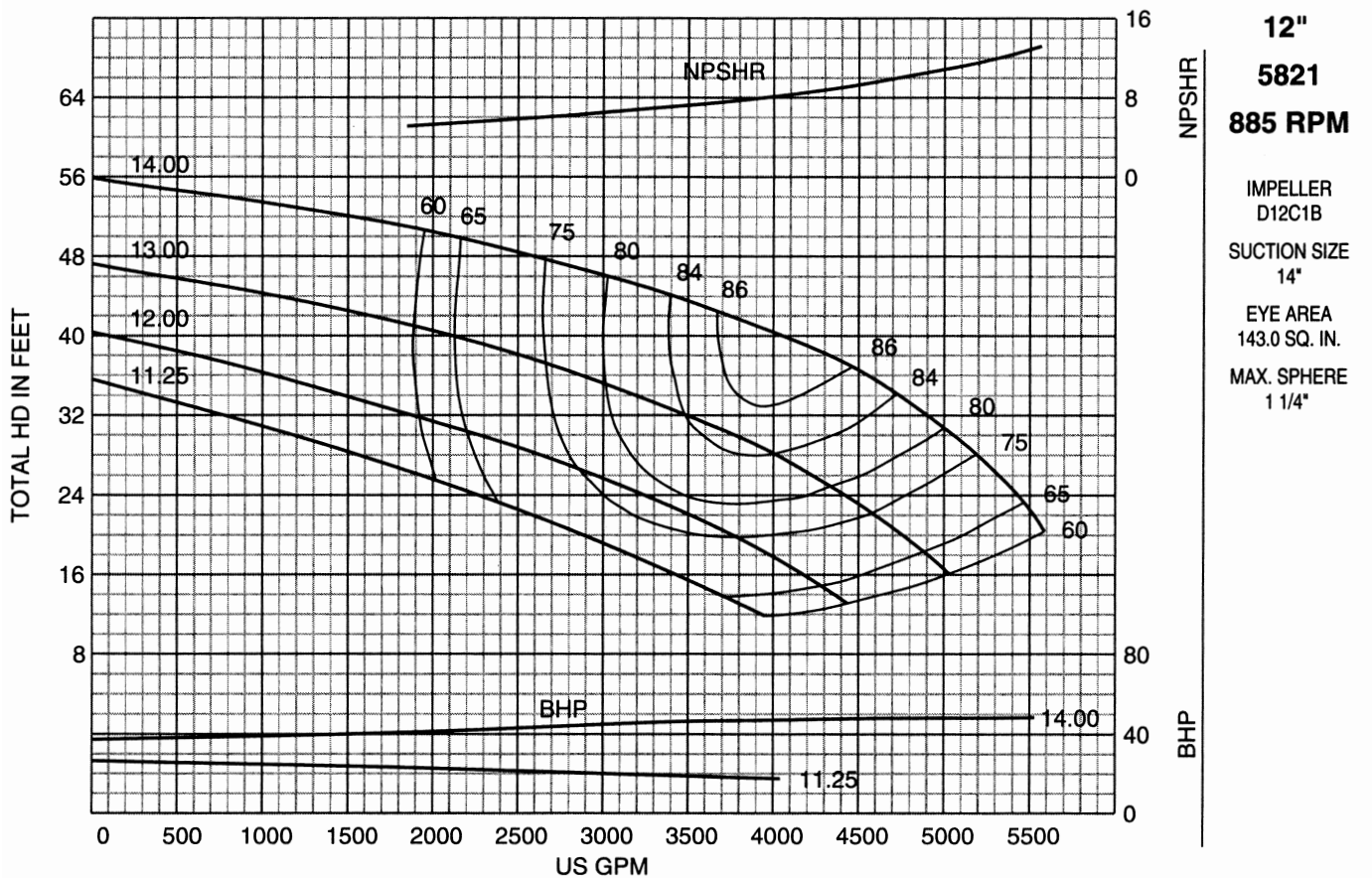
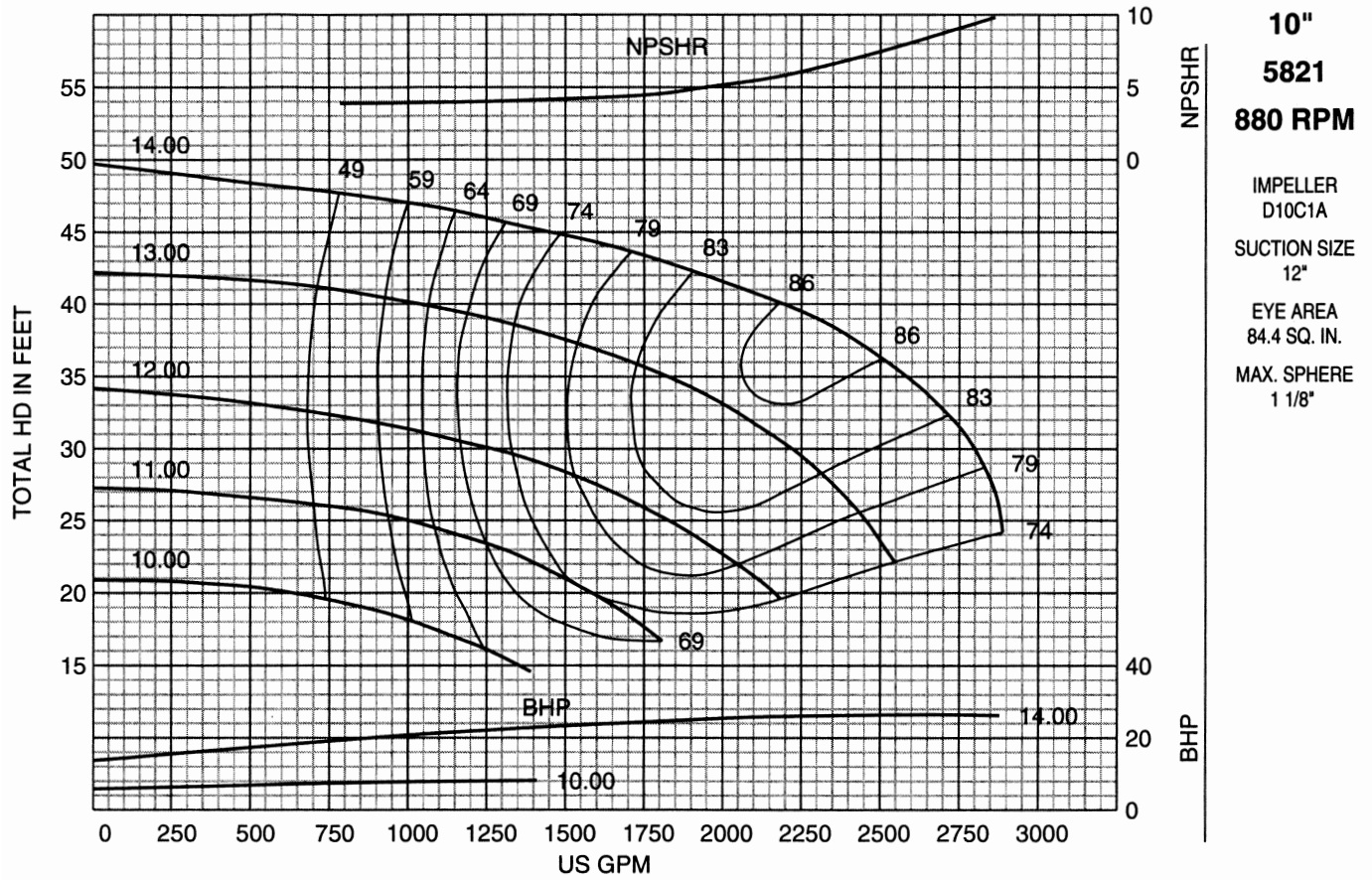



**14"**  
**5821**  
**885 RPM**

IMPELLER  
D14C1A  
SUCTION SIZE  
16"  
EYE AREA  
142.0 SQ. IN.  
MAX. SPHERE  
1 1/4"

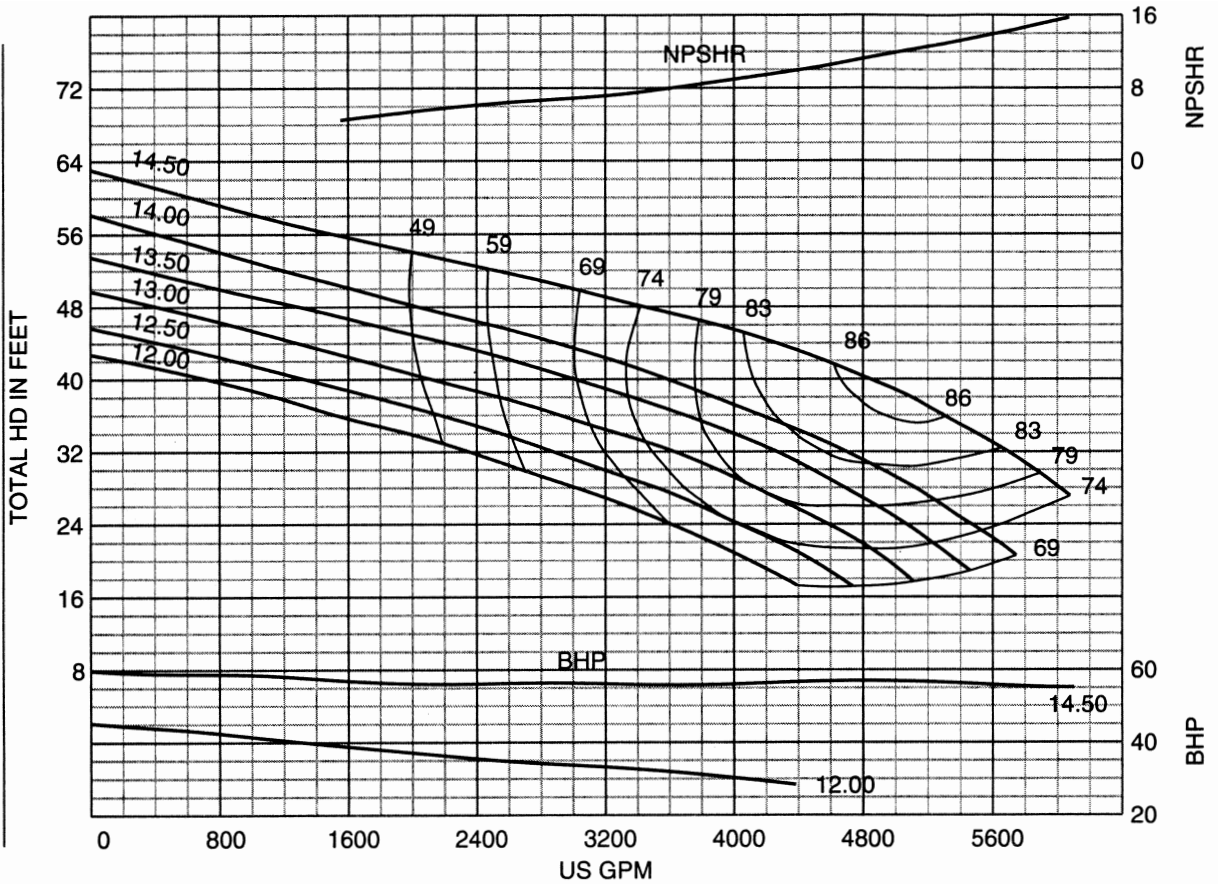

**20"**  
**5821**  
**890 RPM**

IMPELLER  
D20C1A  
SUCTION SIZE 20"  
EYE AREA  
245.7 SQ. IN.  
MAX. SPHERE  
1-1/2"

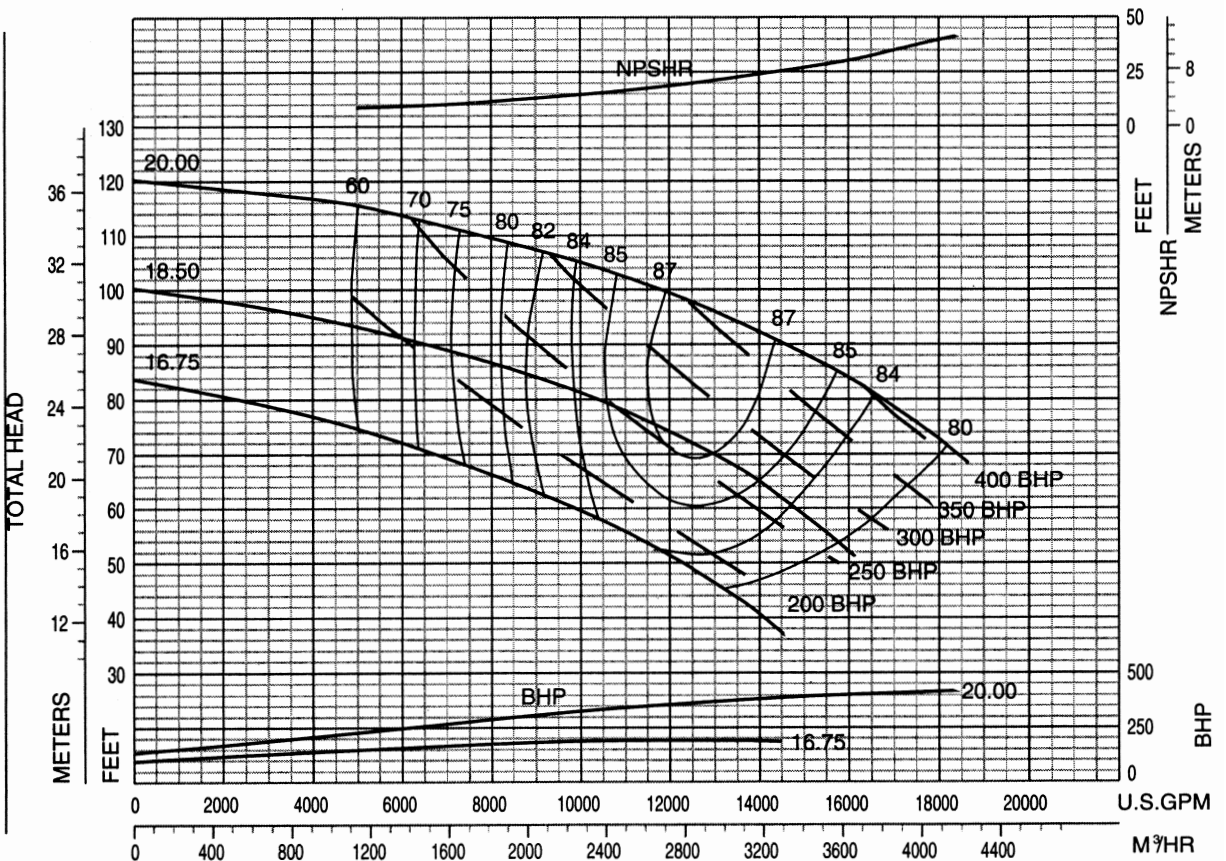



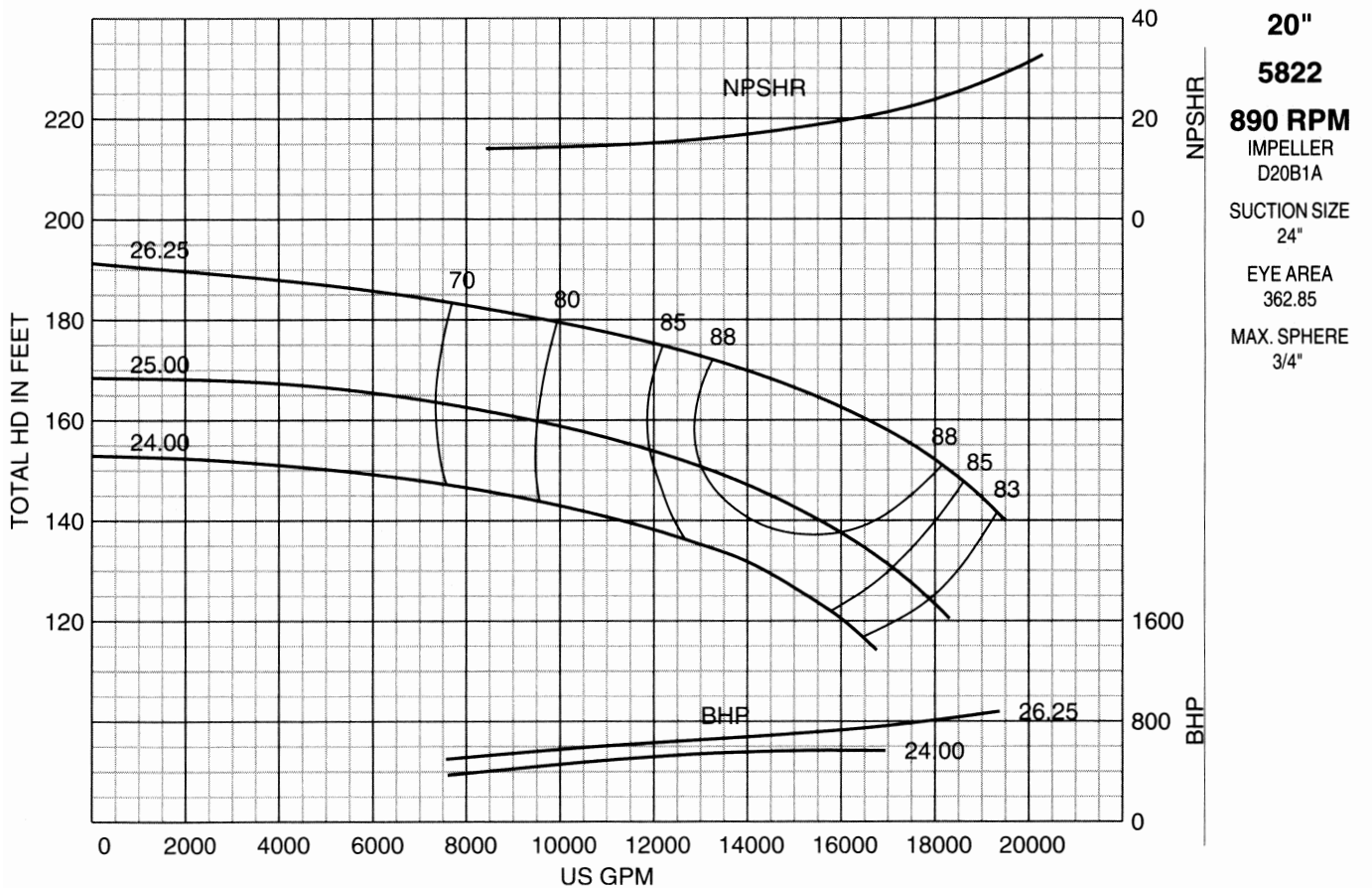
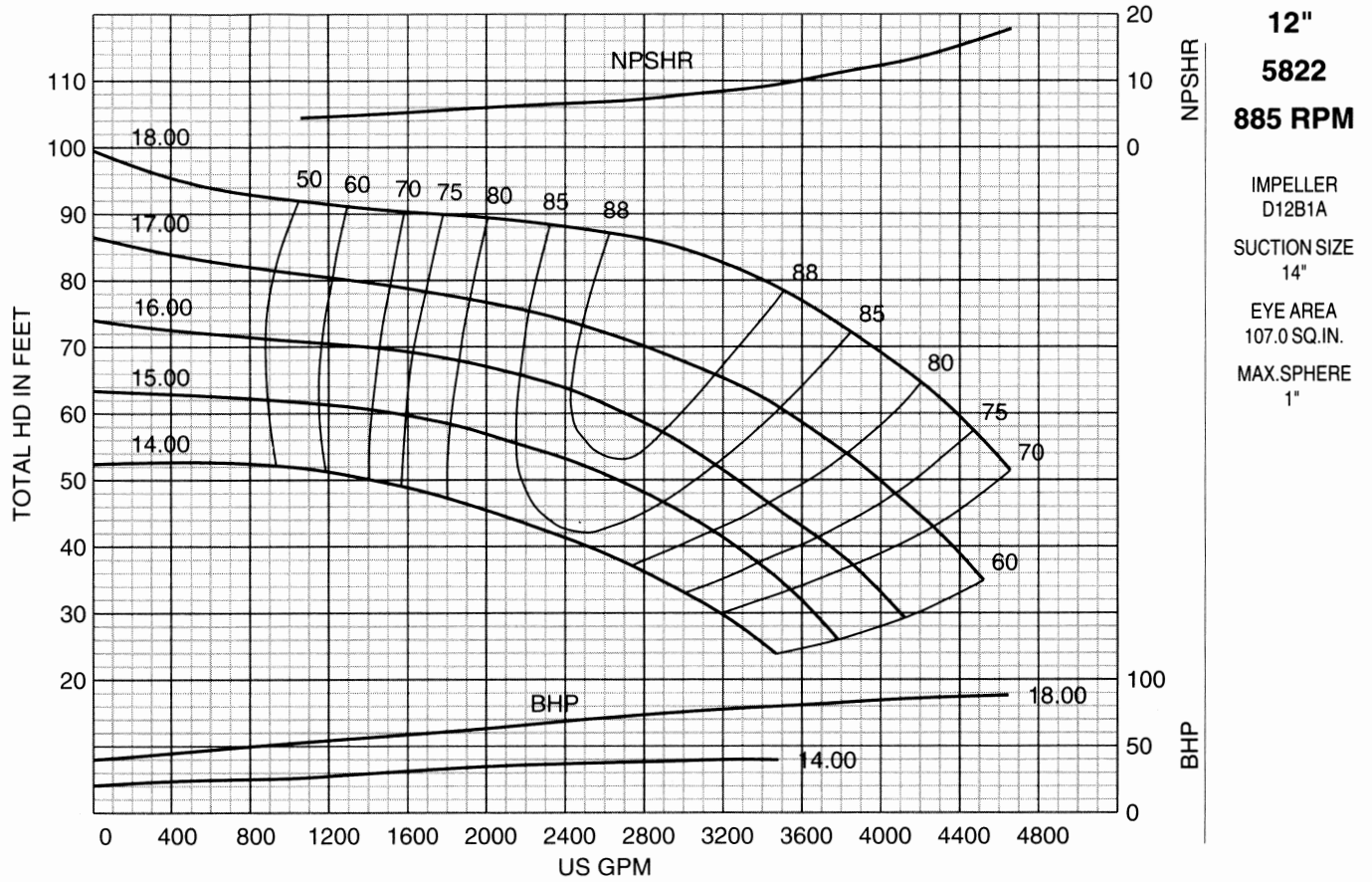

**12"**  
**5823**  
**890 RPM**

IMPELLER  
 D12A1A  
 SUCTION SIZE  
 14"  
 EYE AREA  
 149.0 SQ.IN.  
 MAX.SPHERE  
 1 1/2"

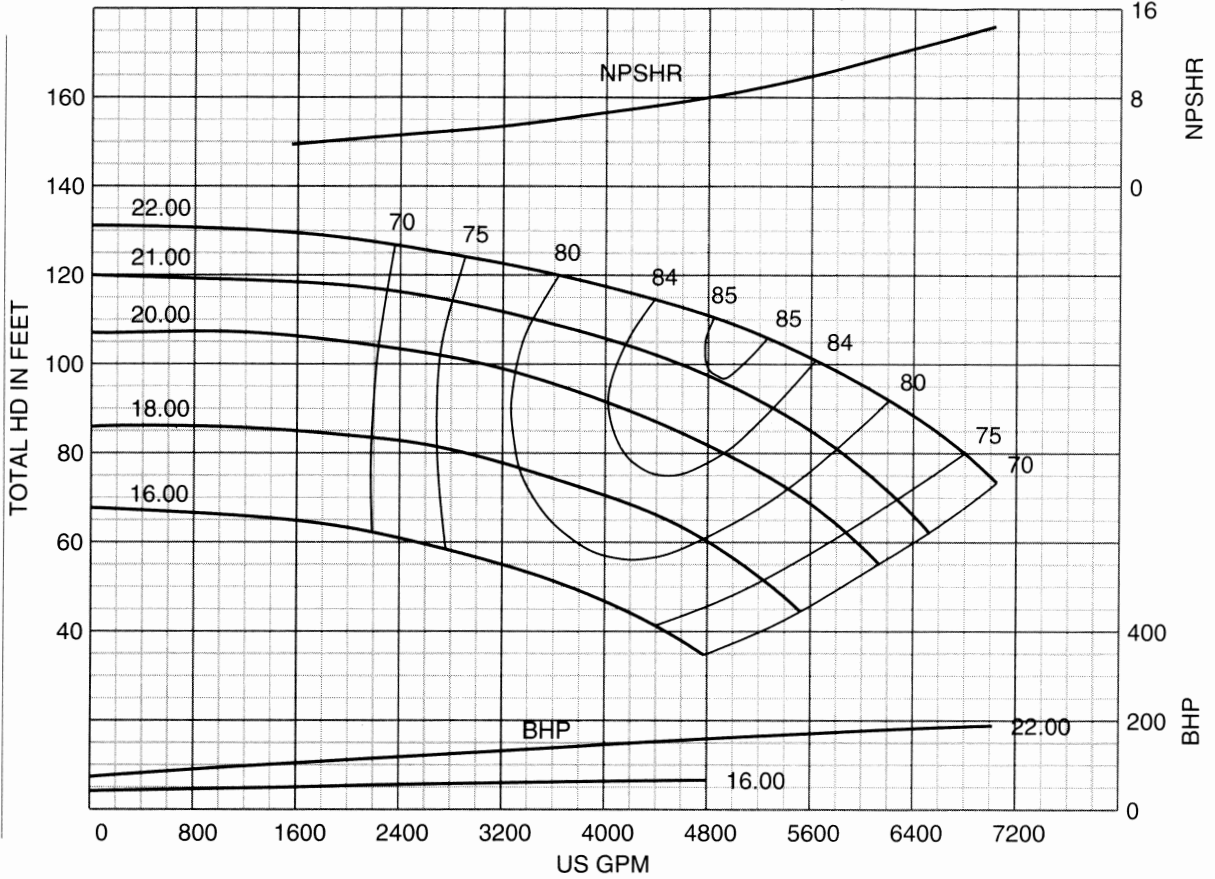

**16"**  
**5823**  
**890 RPM**

IMPELLER  
 M16A1A  
 SUCTION SIZE 20"  
 EYE AREA  
 192.6 SQ.IN.  
 MAX. SPHERE  
 1-3/4"

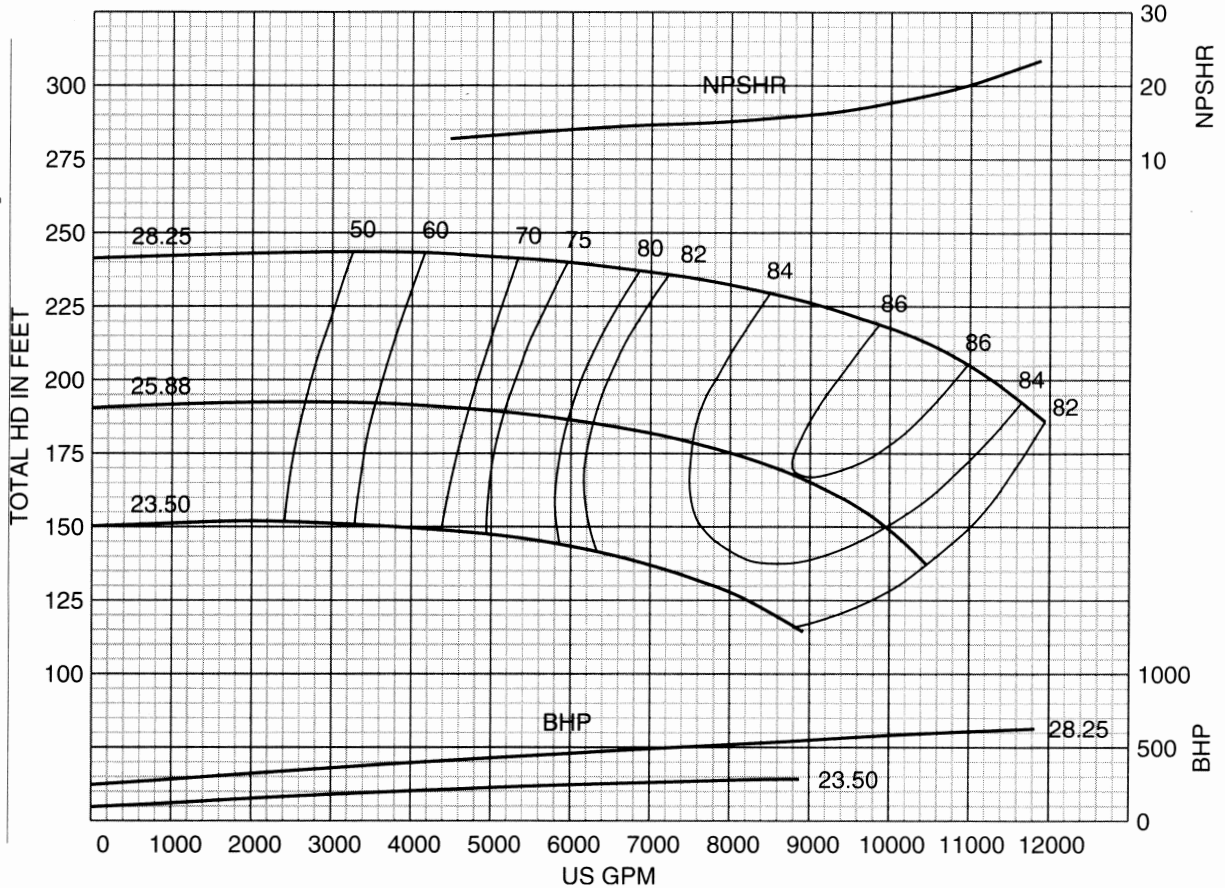



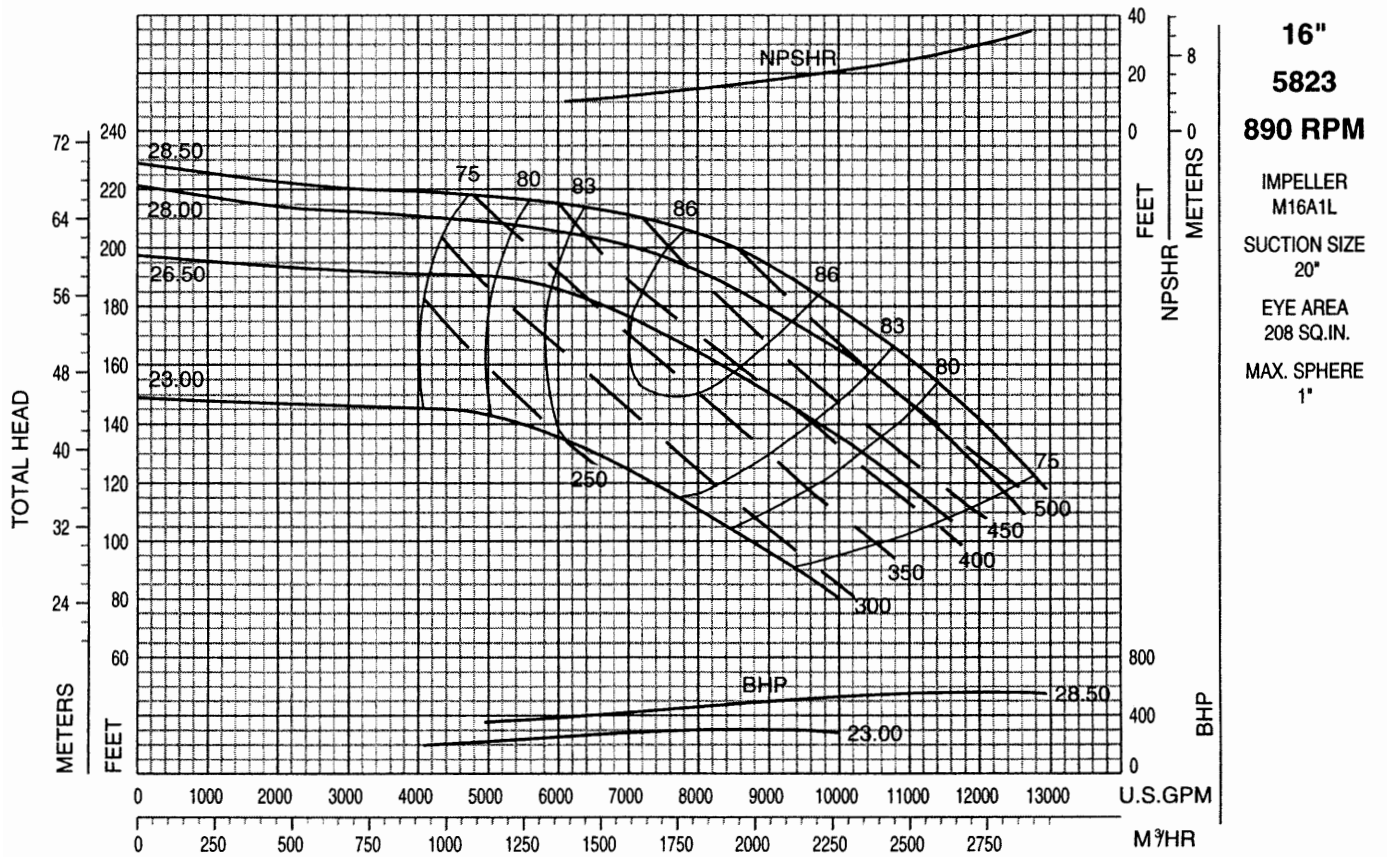
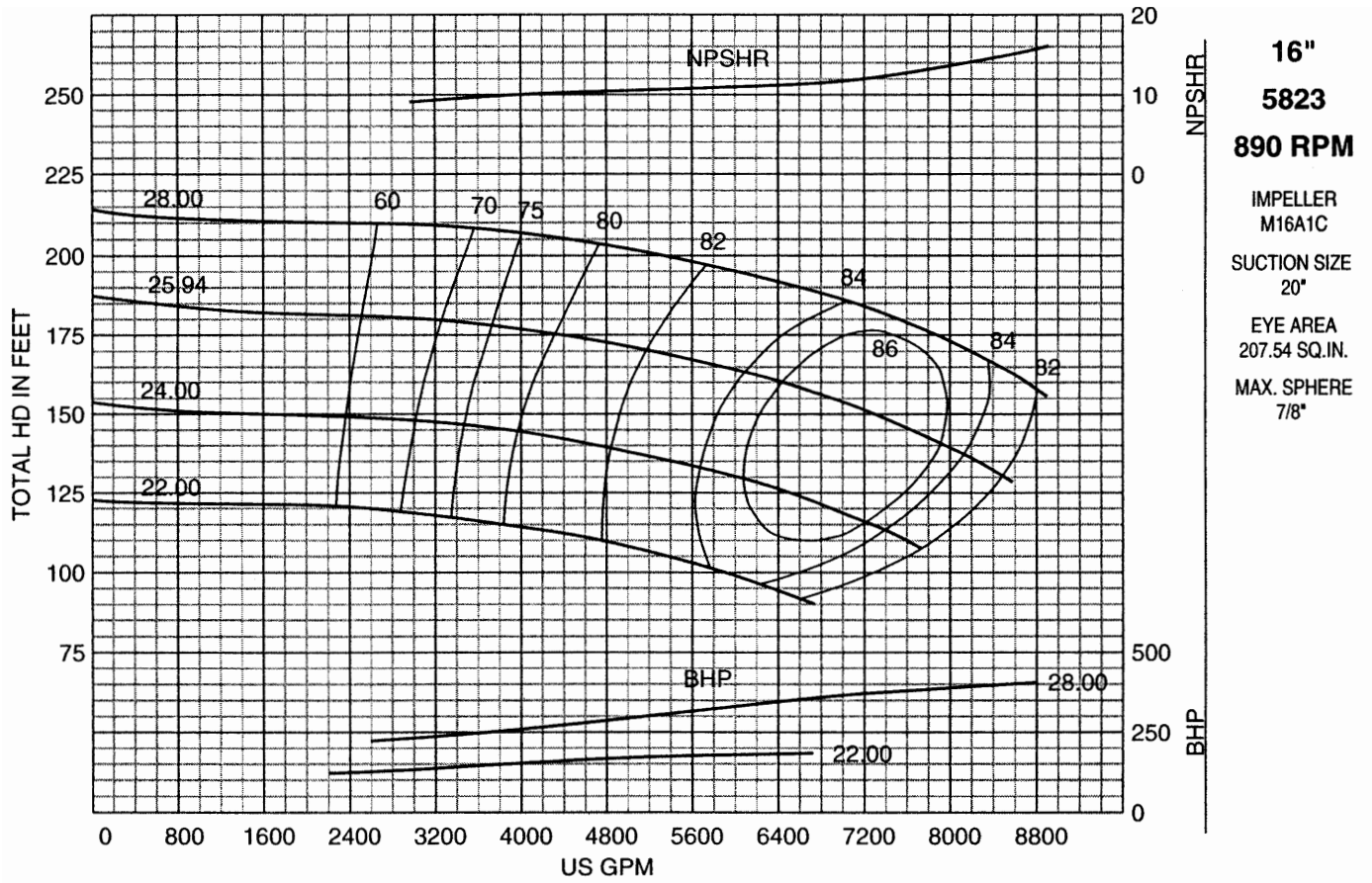

**20"**  
**5823**

**890 RPM**

IMPELLER  
 D20A1A

SUCTION SIZE  
 24"

EYE AREA  
 317.77 SQ. IN.

MAX SPHERE  
 2.25"

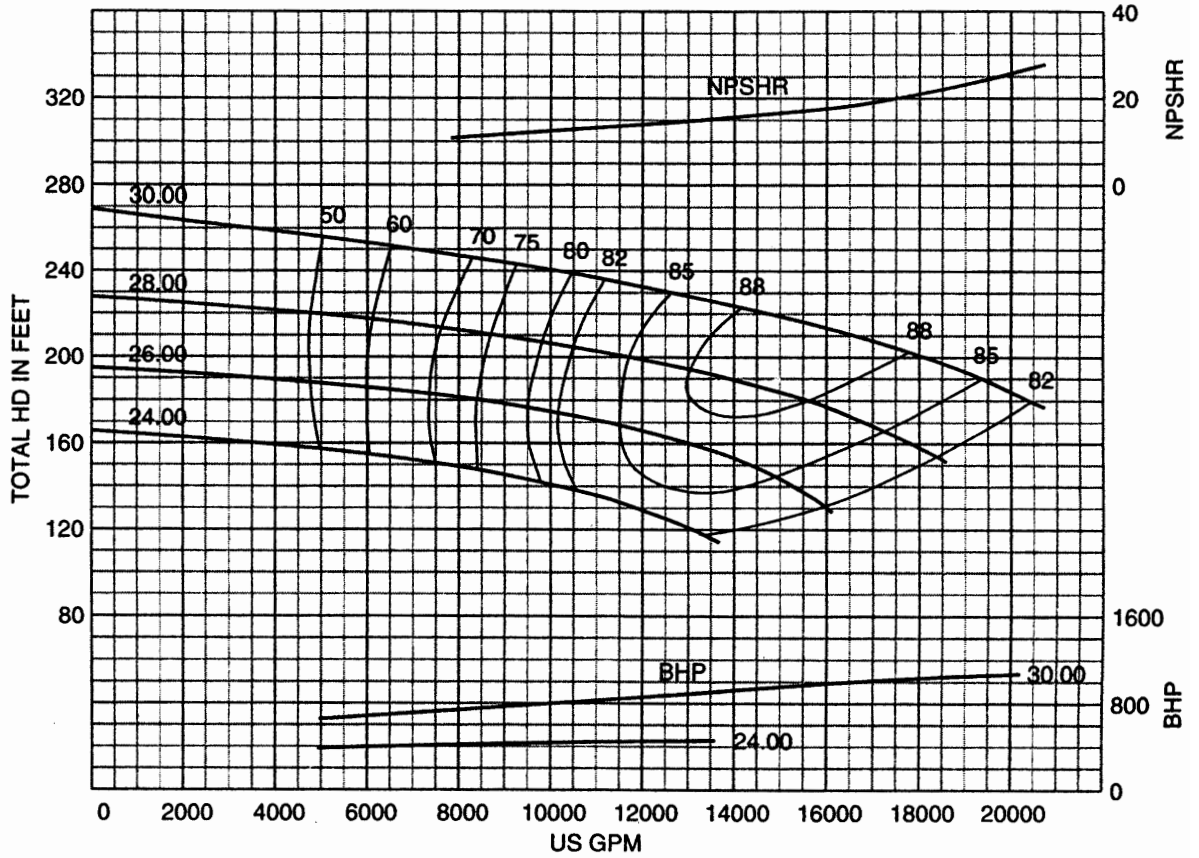

**18"**  
**5823**

**890 RPM**

IMPELLER  
 D18A1B

SUCTION SIZE  
 24"

EYE AREA  
 330 SQ. IN.

MAX SPHERE  
 1.7"

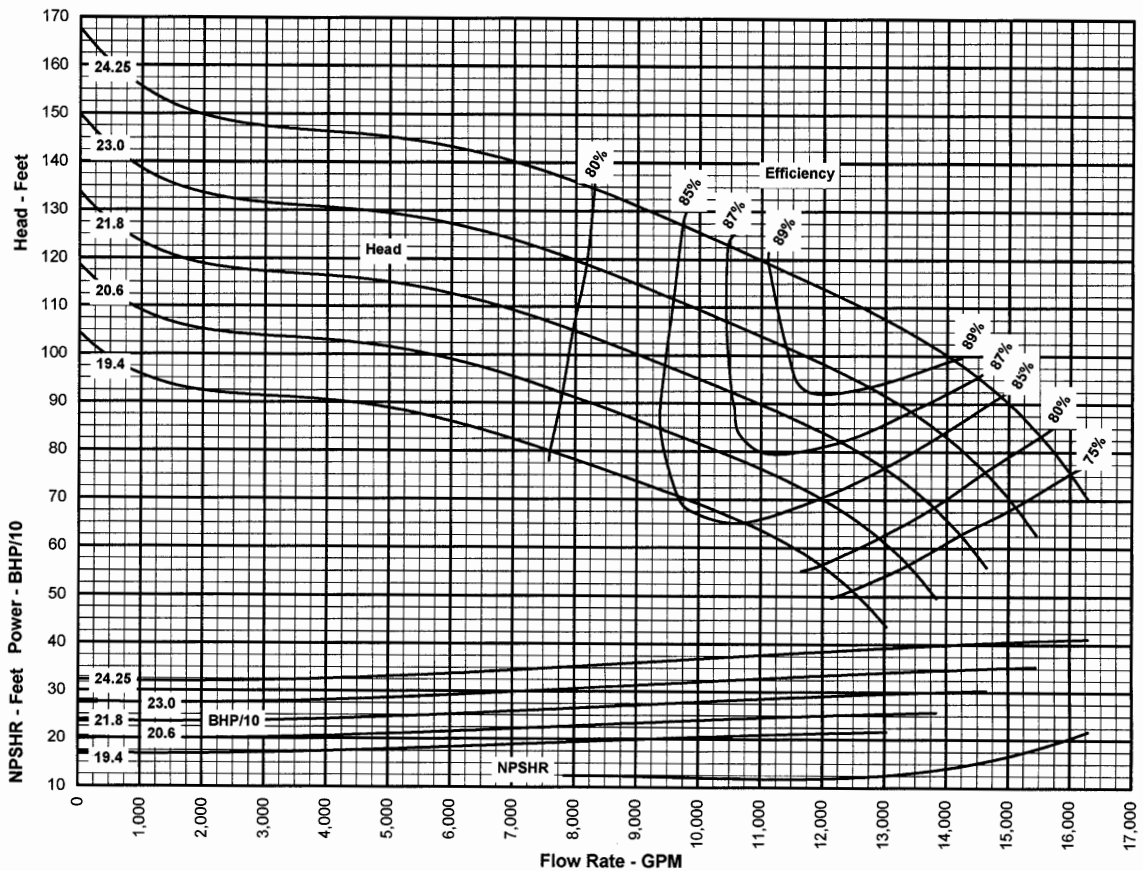



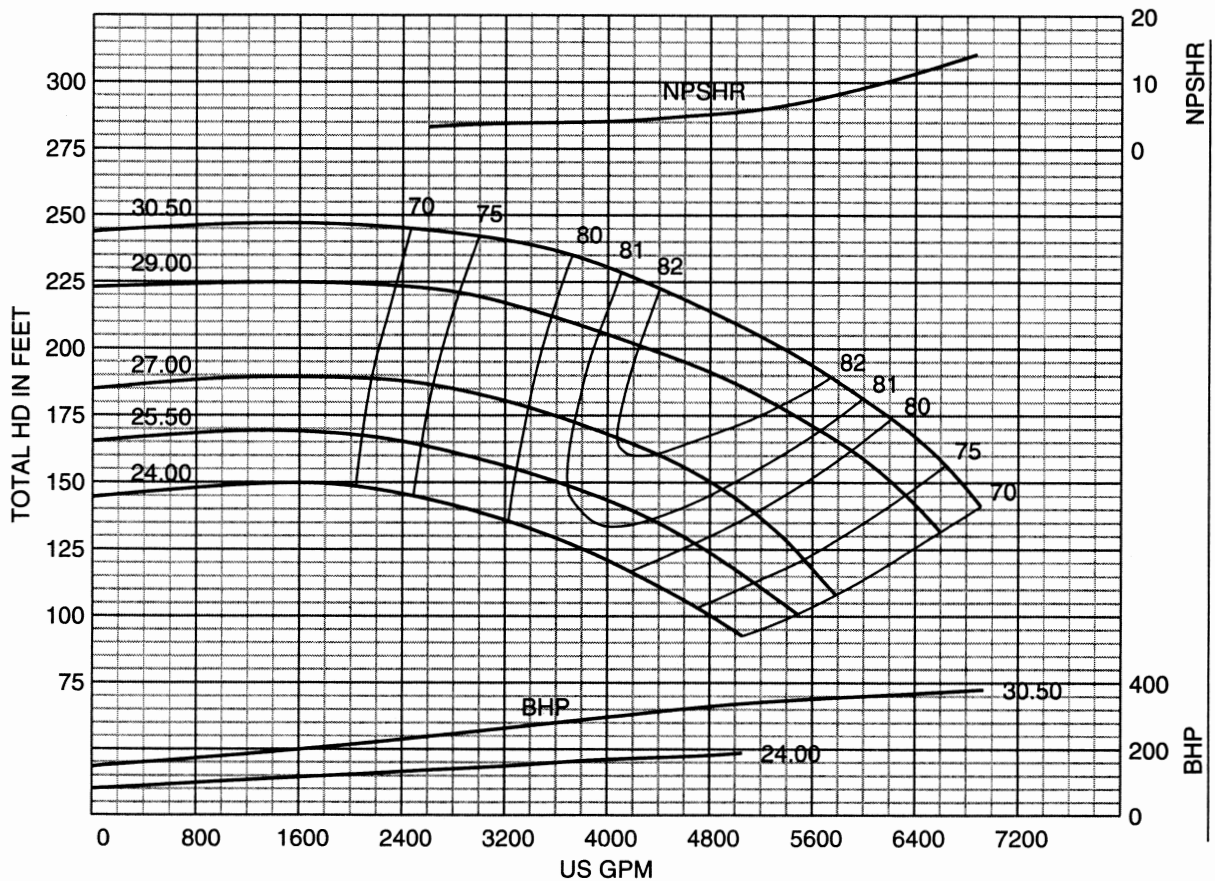
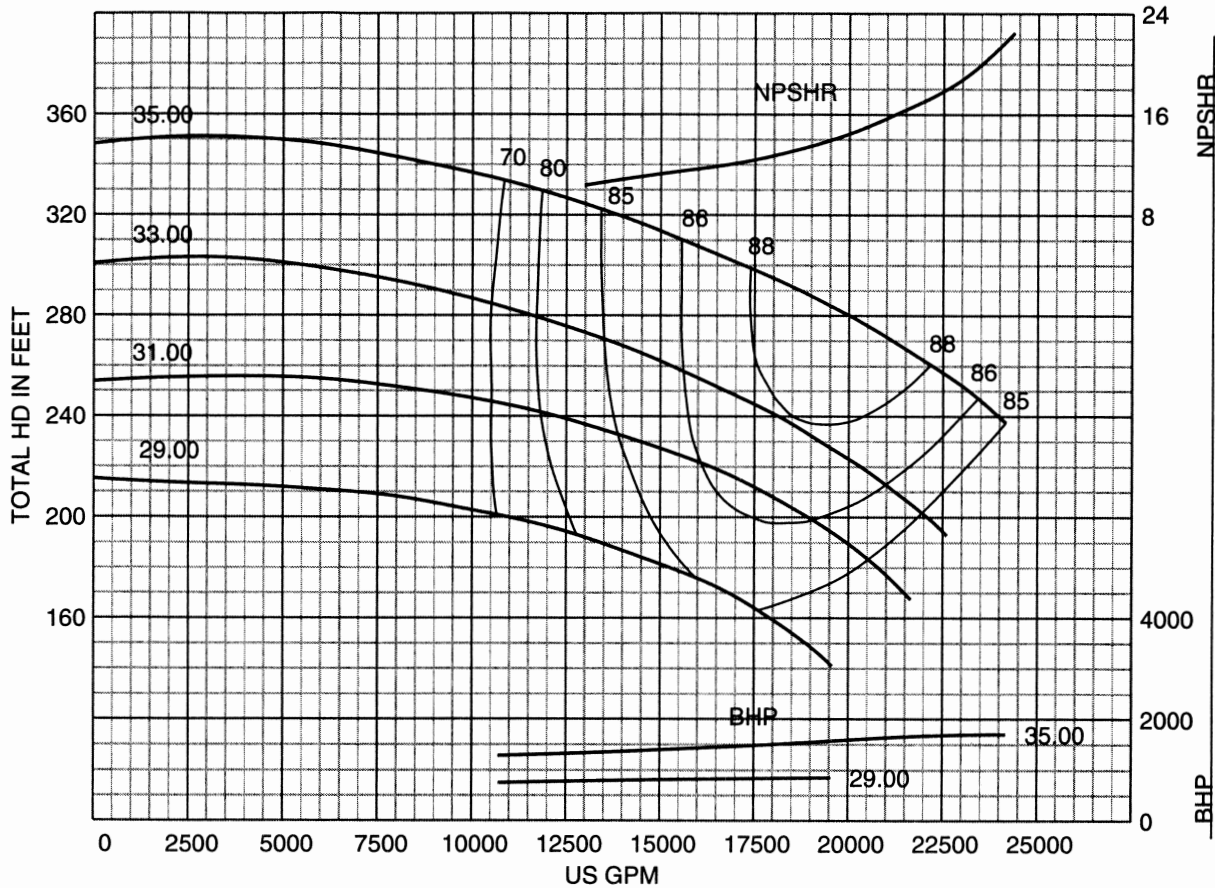

 Notes:



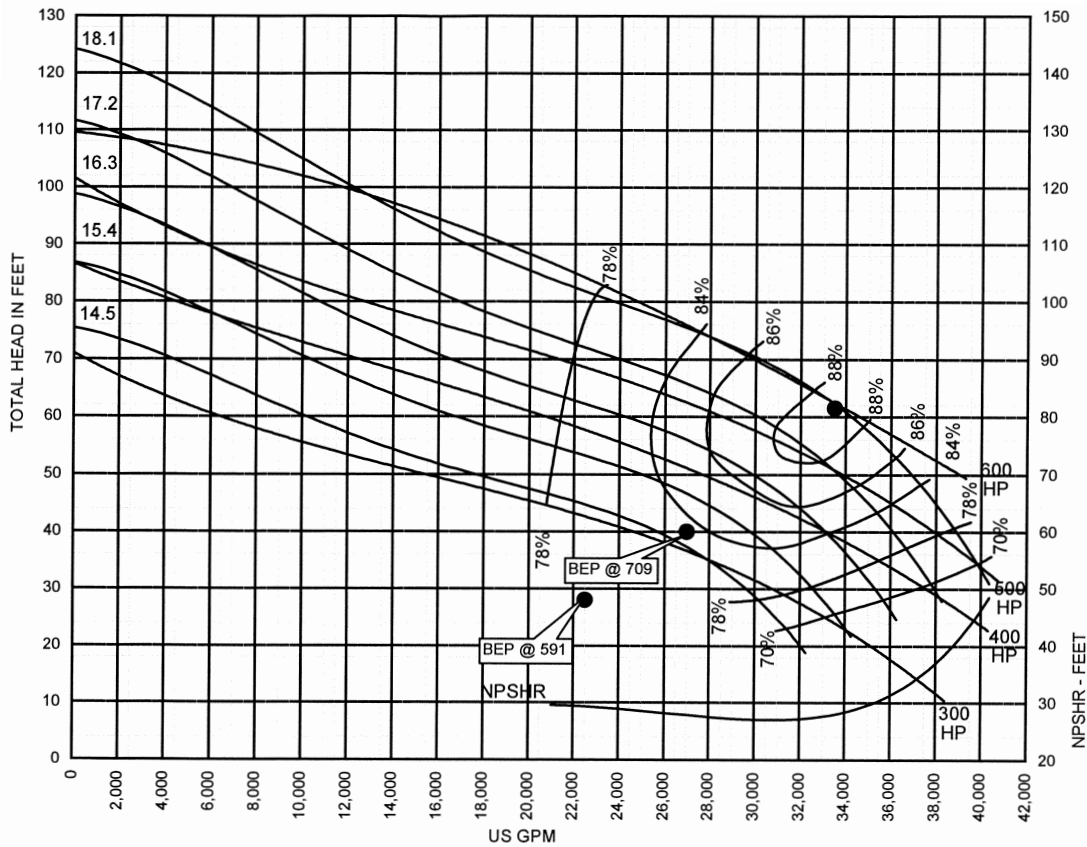

**24"**  
**5823A**

**885 RPM**

IMPELLER  
D24L1A

SUCTION SIZE  
30"

EYE AREA  
503"

MAX SPHERE  
2.1"

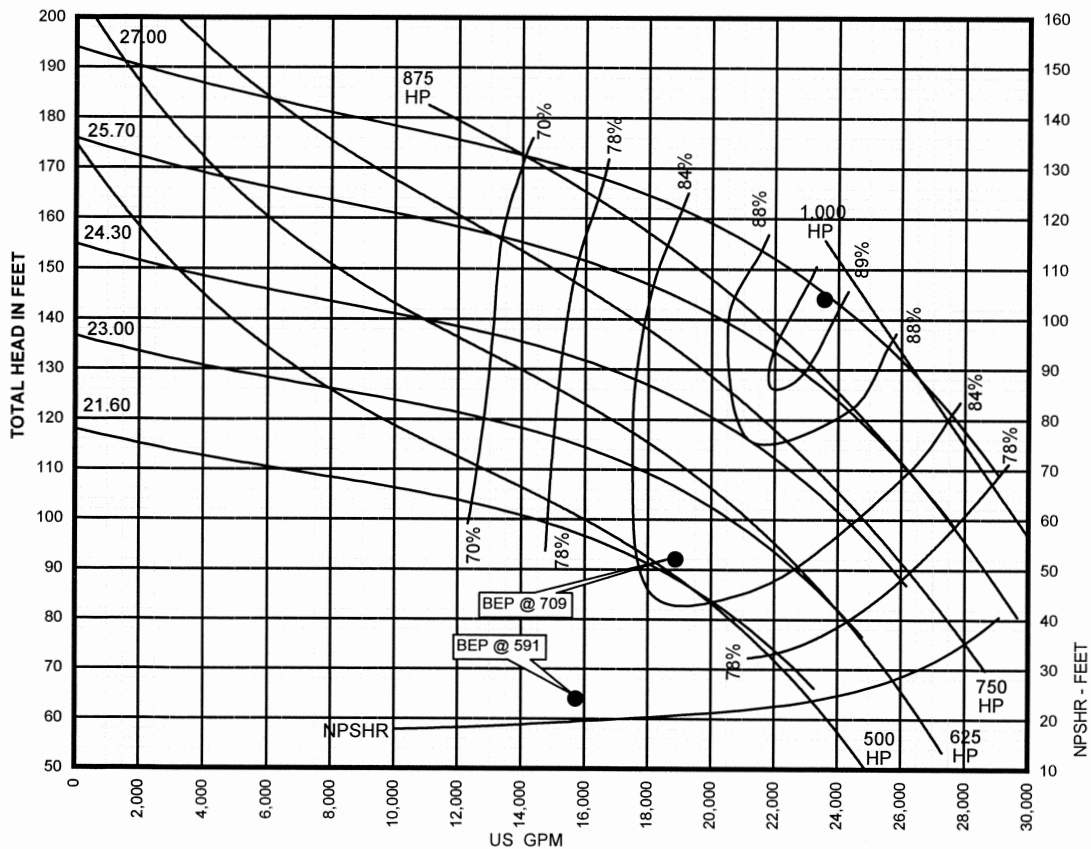

**20"**  
**5825A**

**885 RPM**

IMPELLER  
D20M1A

SUCTION SIZE  
30"

EYE AREA  
550"

MAX SPHERE  
1.8"

**24"**  
**5826A**  
**885 RPM**  
 IMPELLER  
 D24H1A  
 SUCTION SIZE  
 30"  
 EYE AREA  
 563"  
 MAX SPHERE  
 3.8"

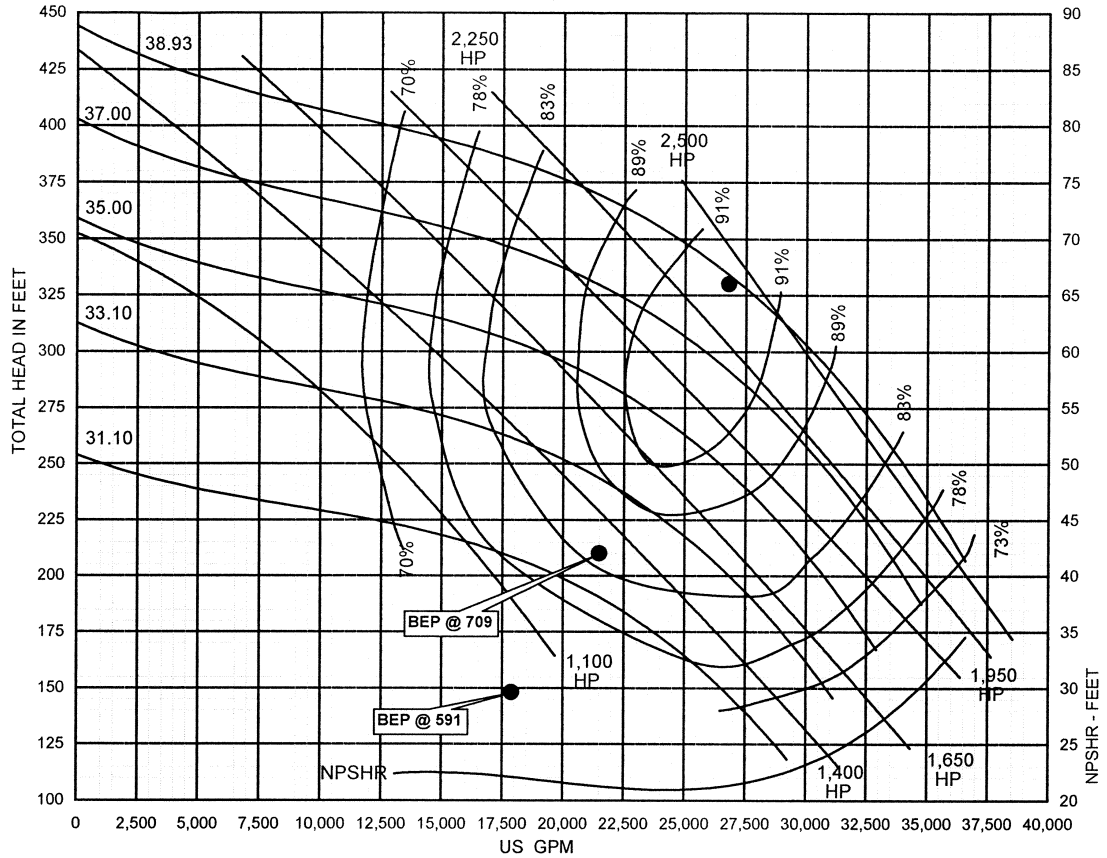

**30"**  
**5826A**  
**885 RPM**  
 IMPELLER  
 D30H1A  
 SUCTION SIZE  
 36"  
 EYE AREA  
 706"  
 MAX SPHERE  
 4.2"

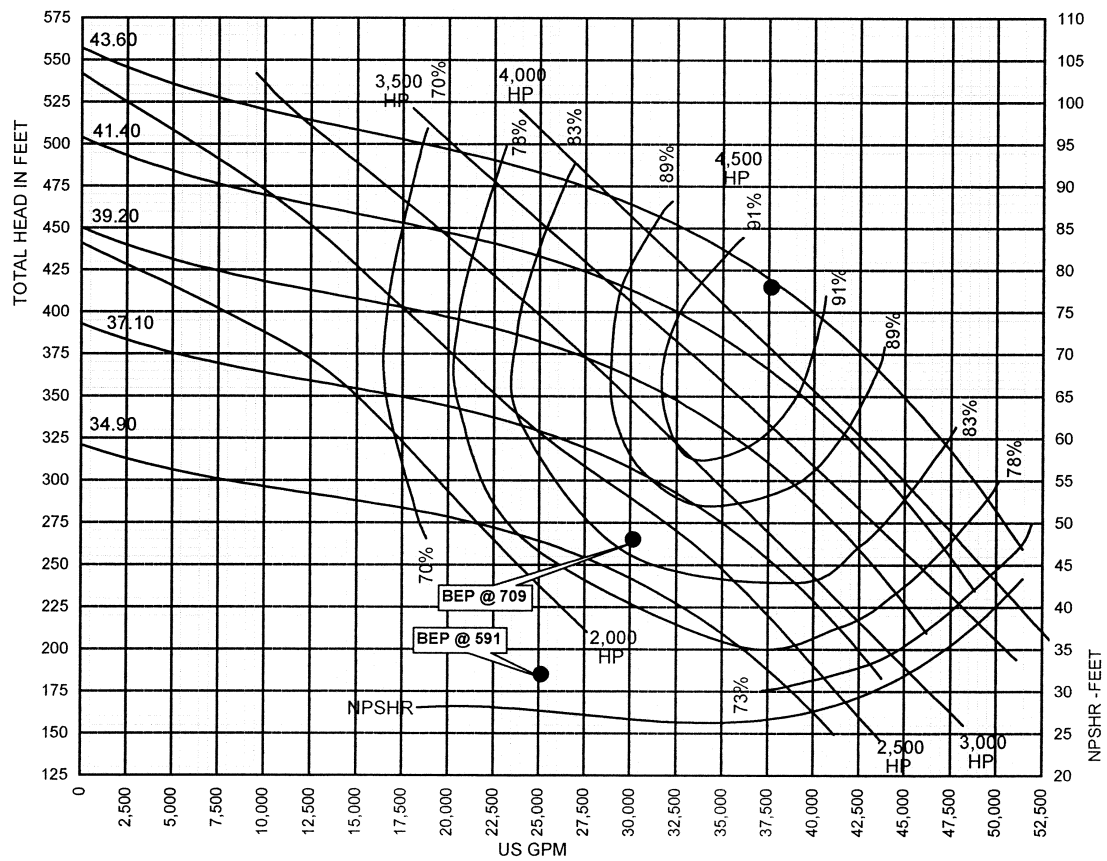



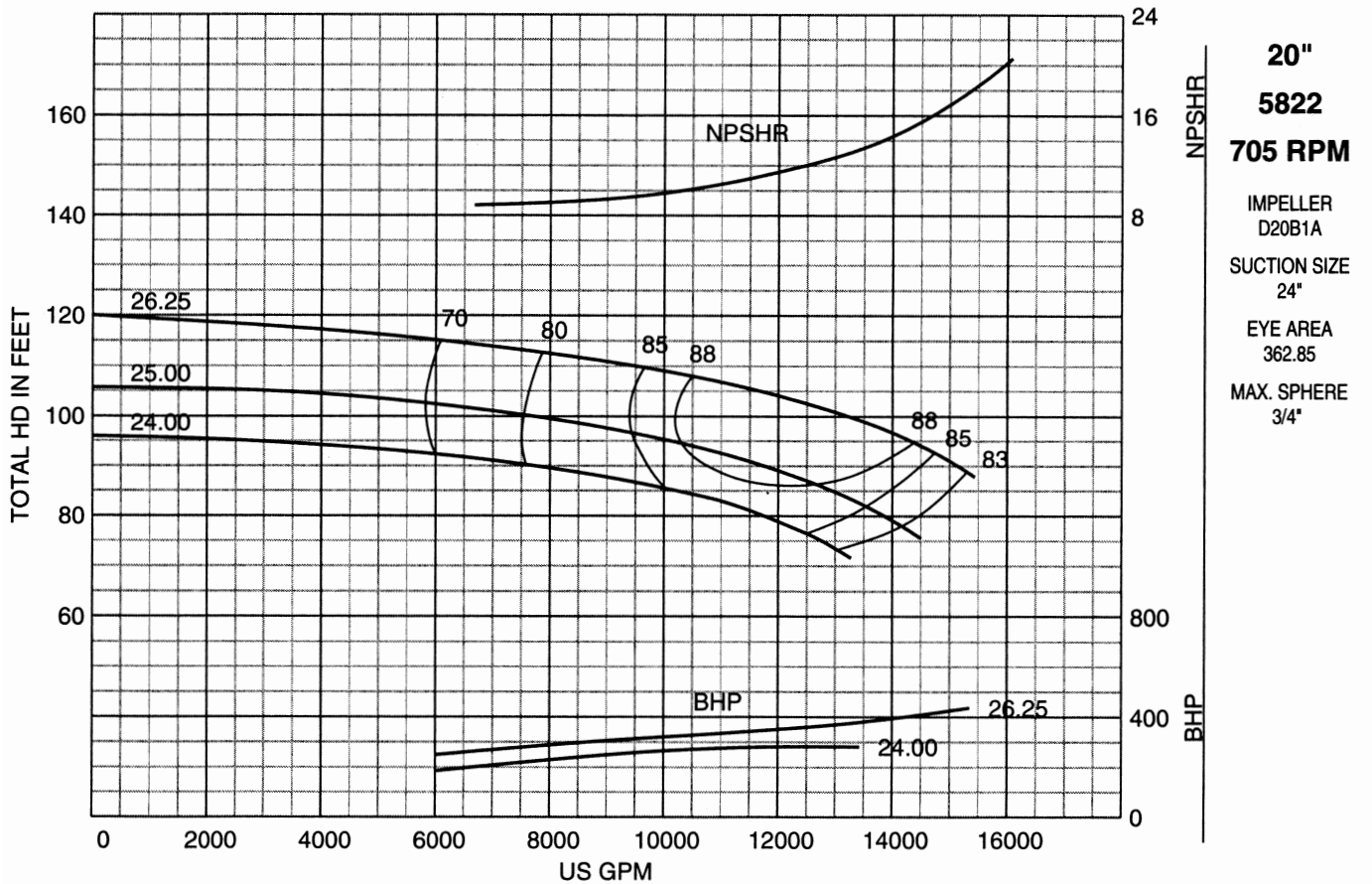
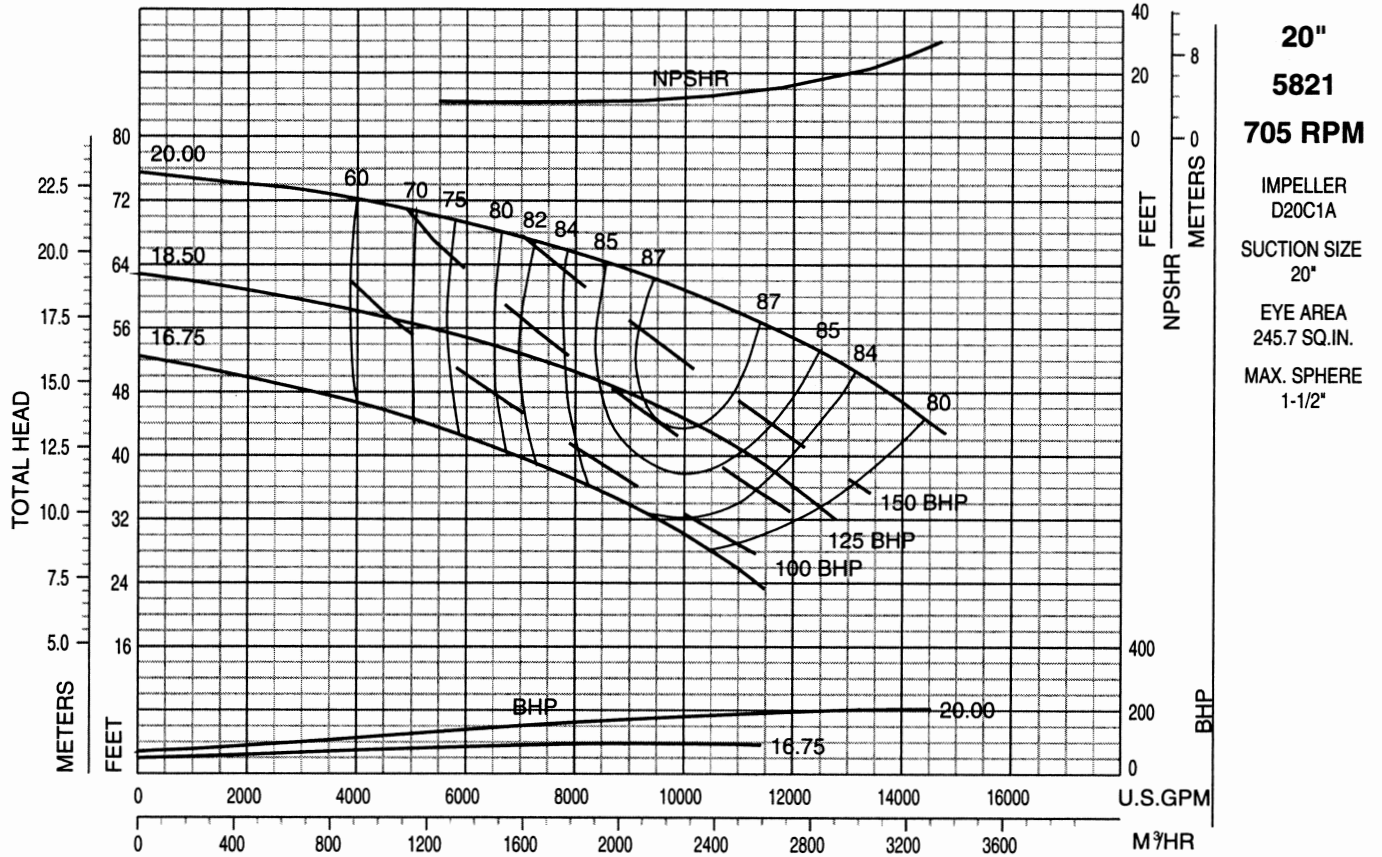

**16"**  
**5823**  
**705 RPM**

IMPELLER  
 M16A1A  
 SUCTION SIZE  
 20"  
 EYE AREA  
 192.6 SQ.IN.  
 MAX. SPHERE  
 1-3/4"

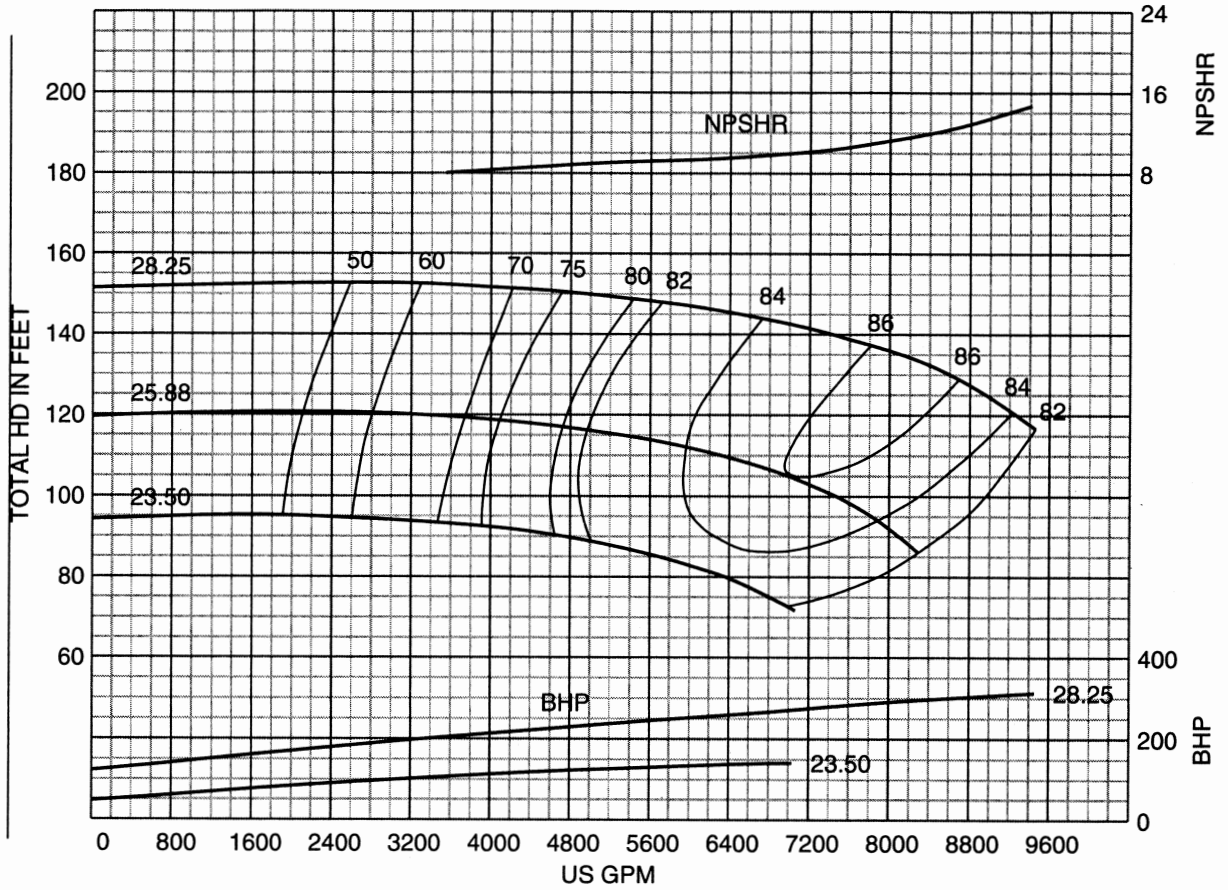

**16"**  
**5823**  
**705 RPM**

IMPELLER  
 M16A1C  
 SUCTION SIZE  
 20"  
 EYE AREA  
 207.54 SQ.IN.  
 MAX. SPHERE  
 7/8"

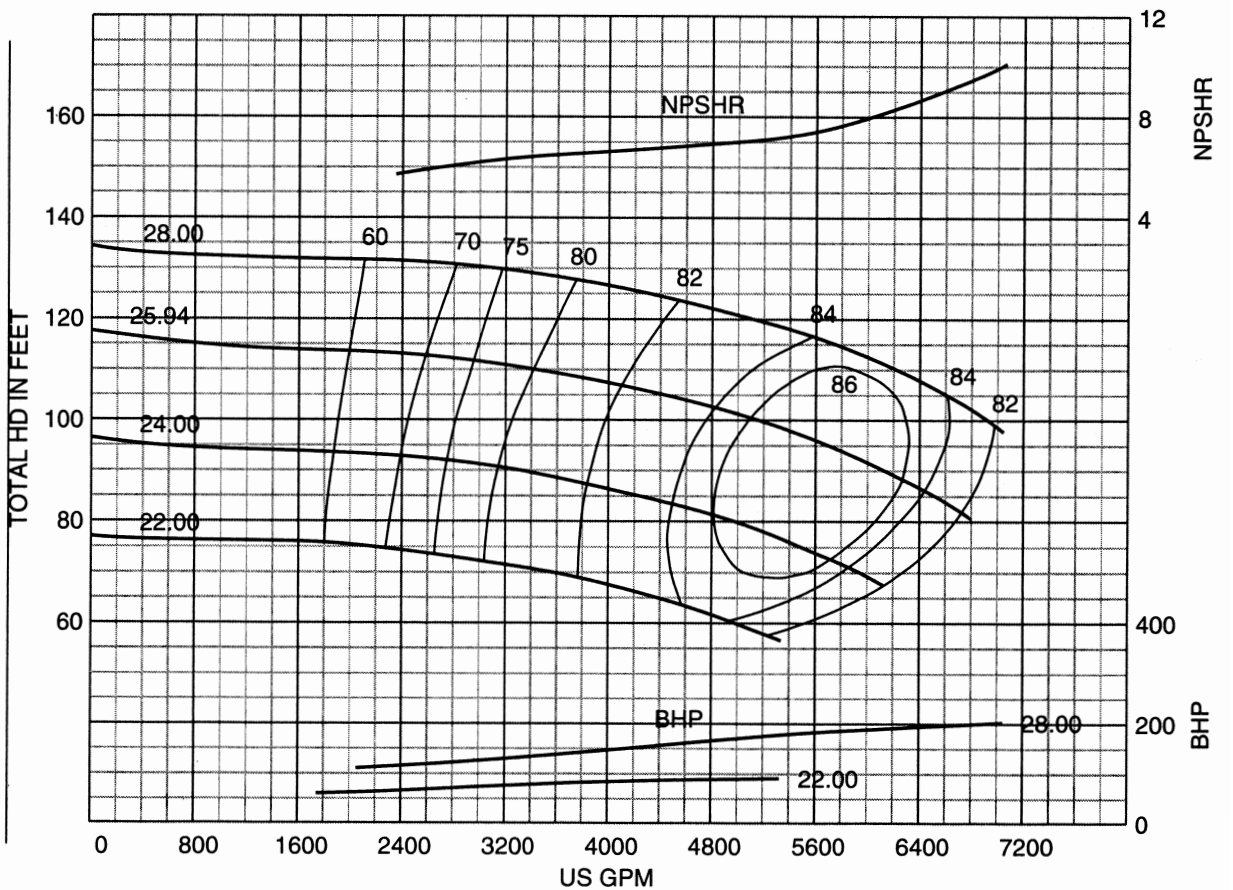



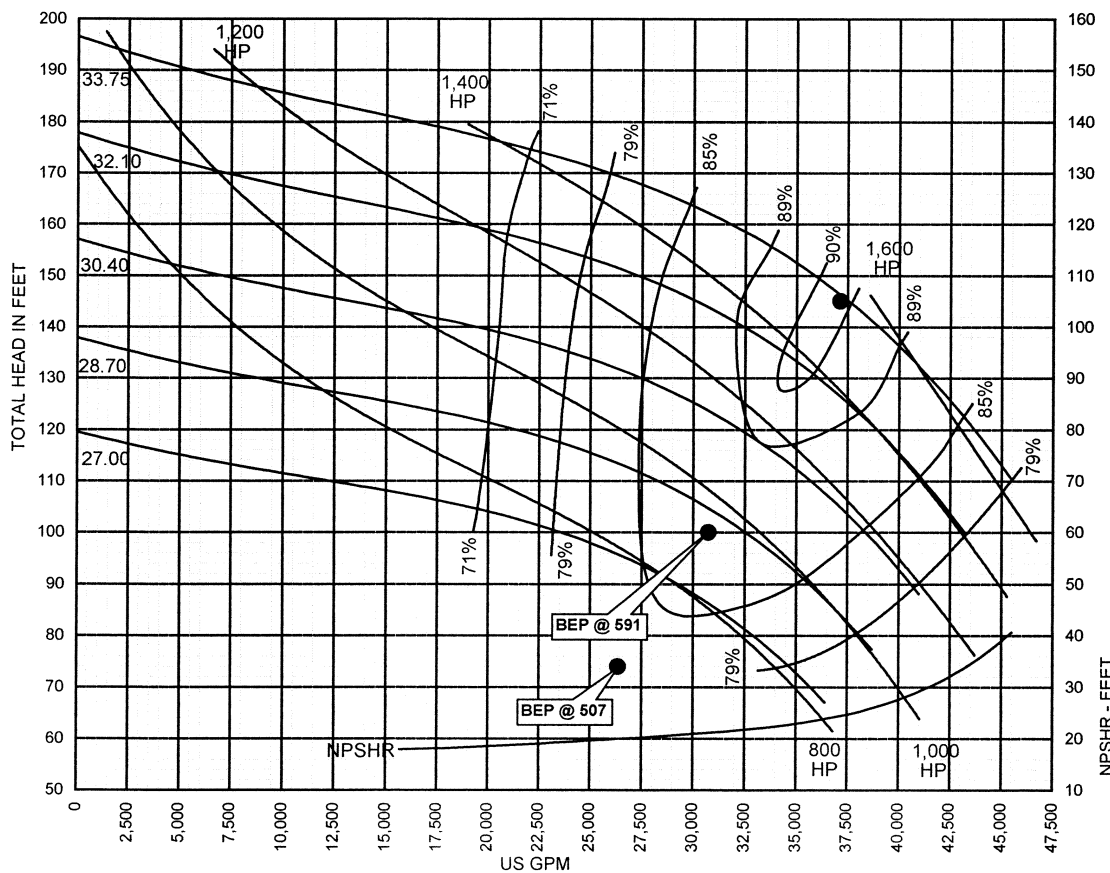
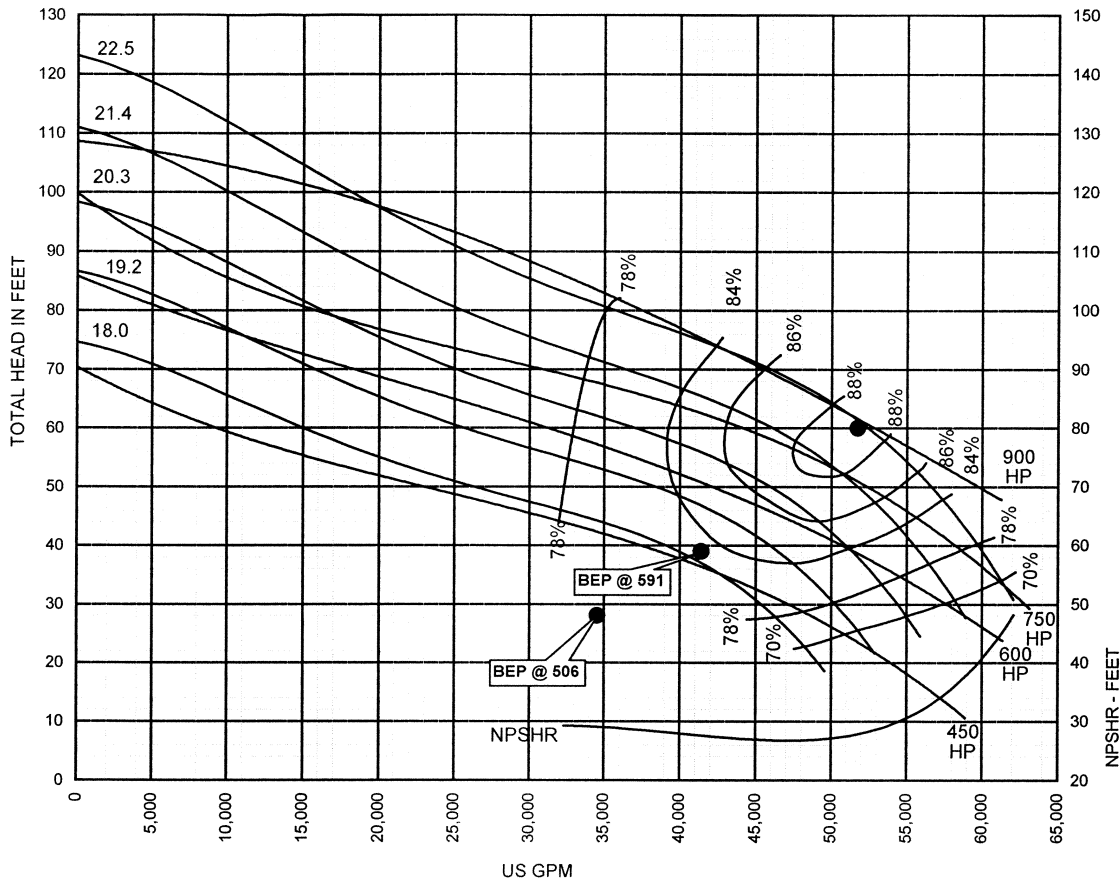

 Notes:



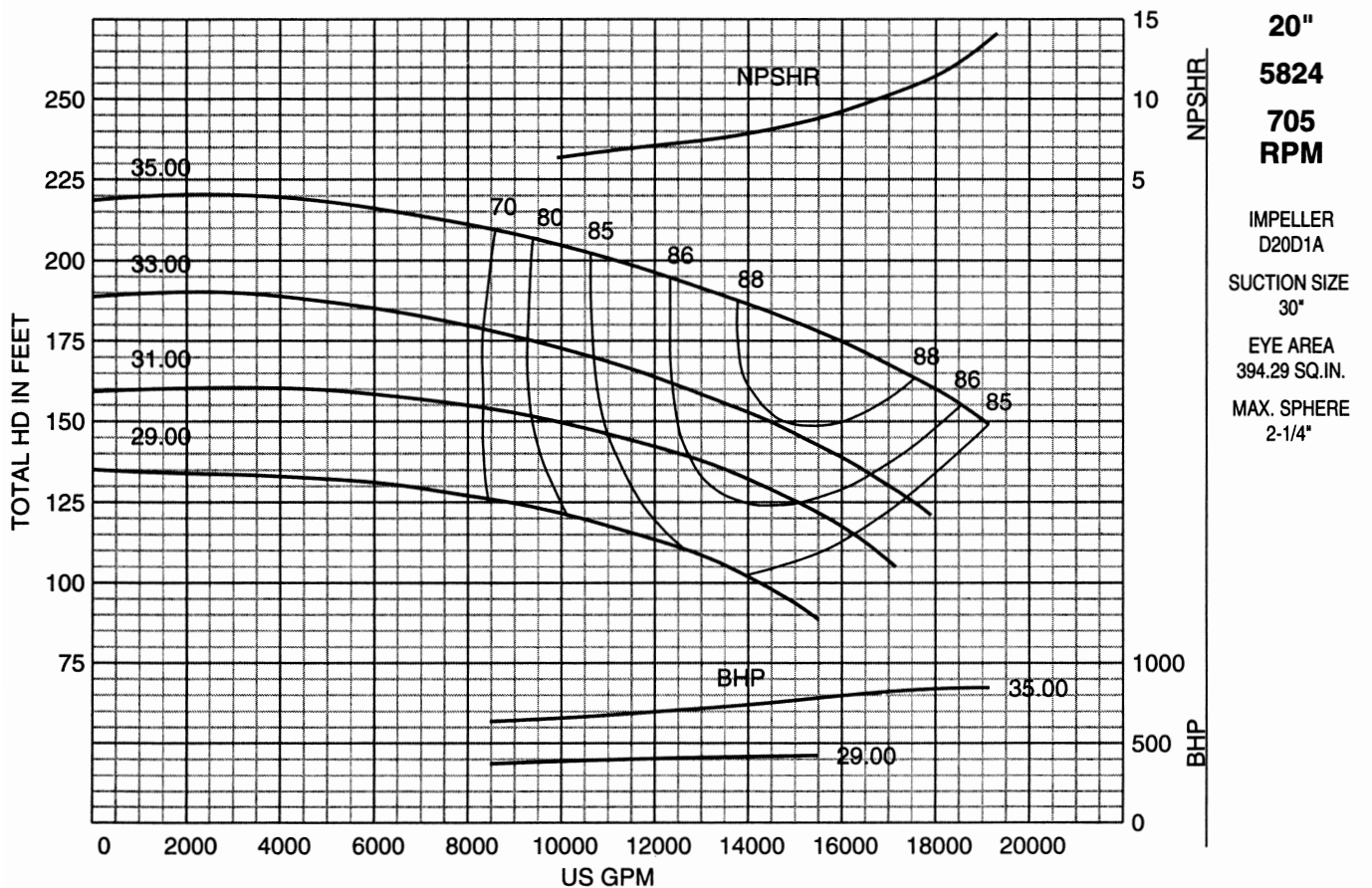
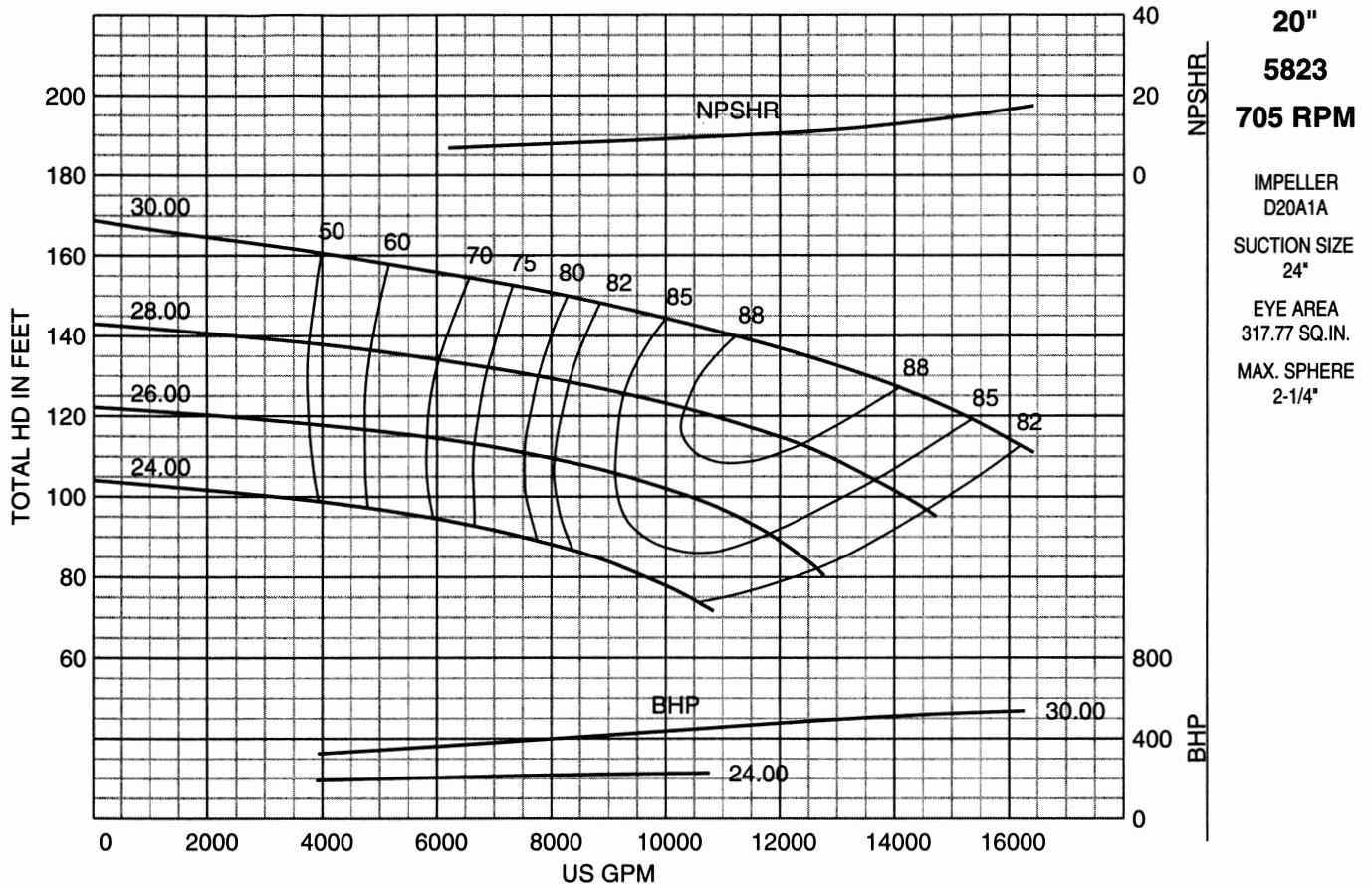

**20"**  
**5821**  
**585 RPM**

IMPELLER  
D20C1A  
SUCTION SIZE  
20"  
EYE AREA  
245.7 SQ.IN.  
MAX. SPHERE  
1-1/2"

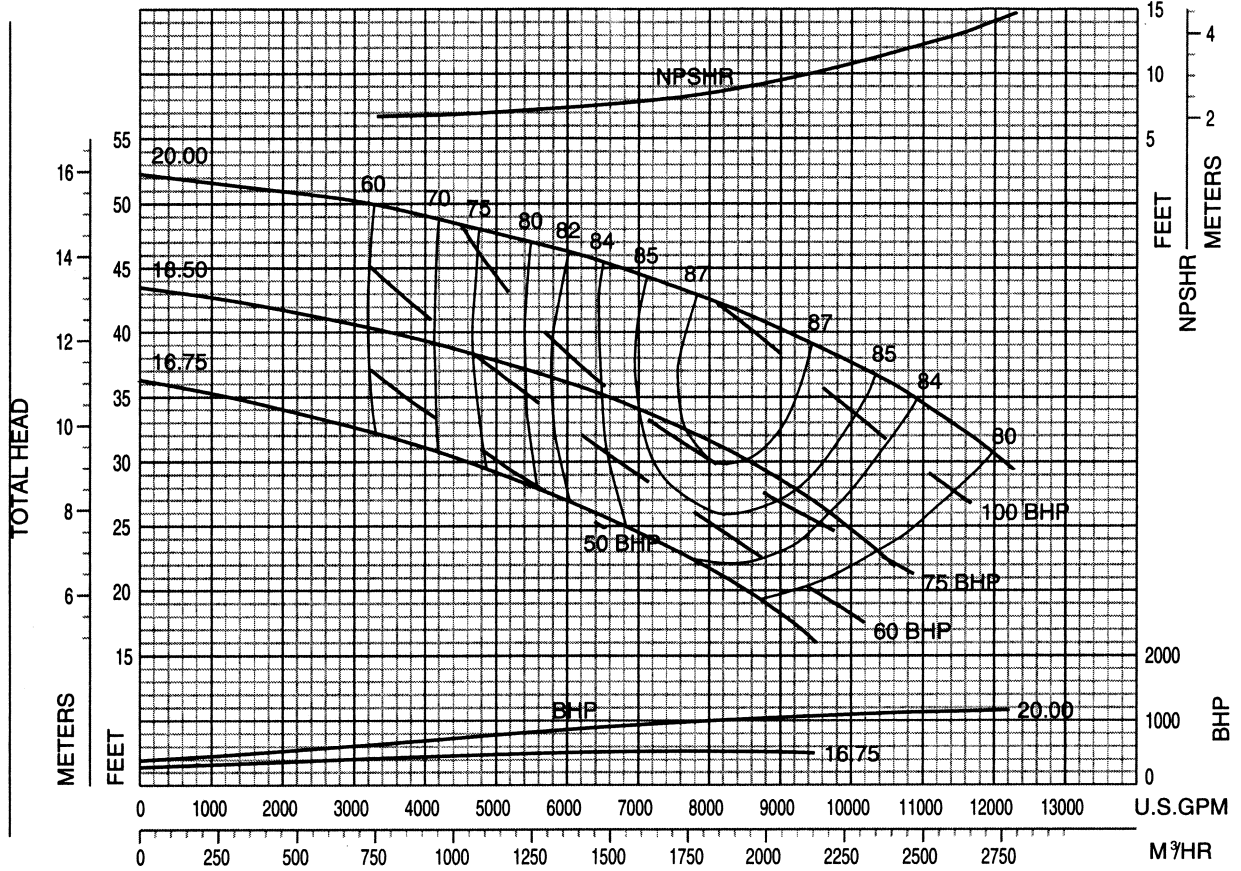

**20"**  
**5822**  
**585 RPM**

IMPELLER  
D20B1A  
SUCTION SIZE  
24"  
EYE AREA  
362.85  
MAX. SPHERE  
3/4"

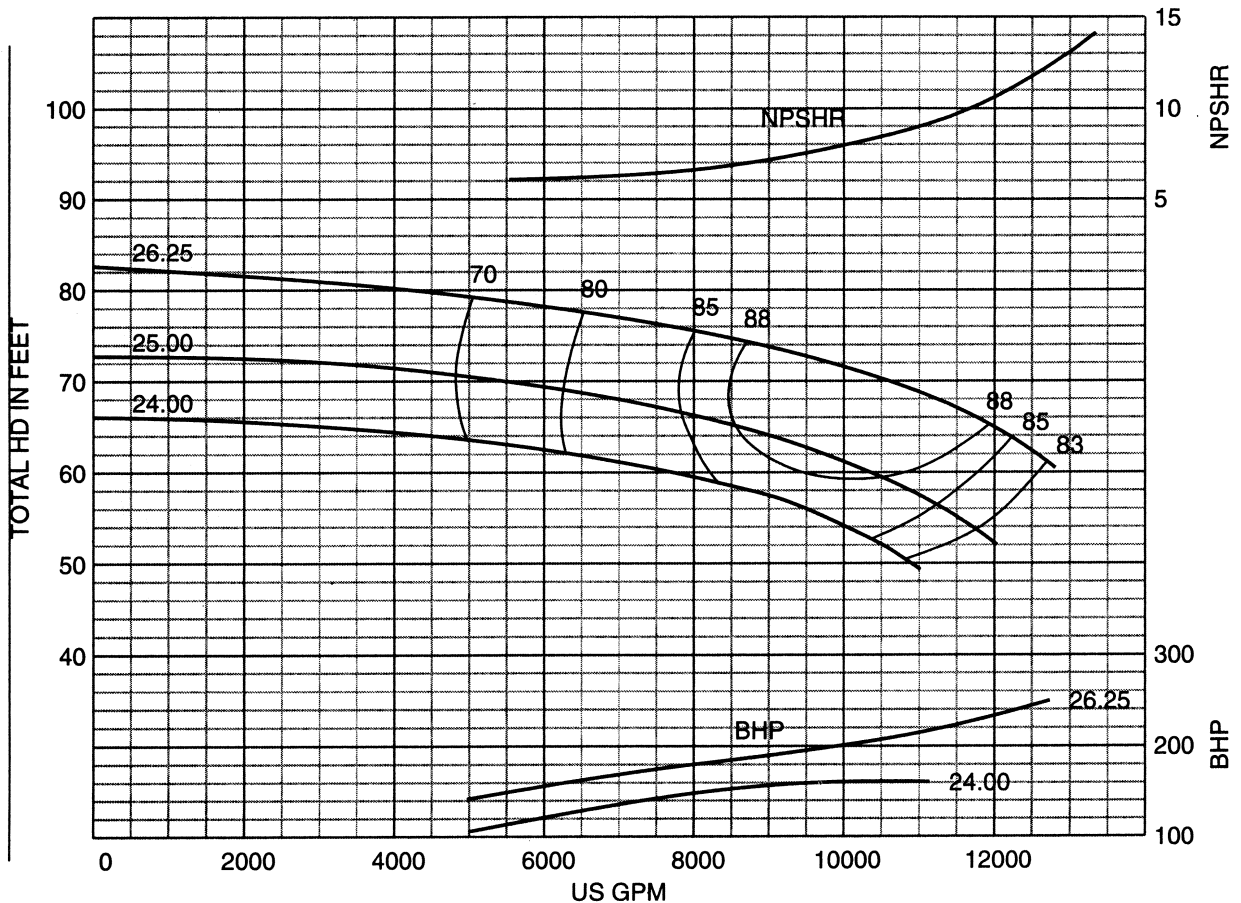



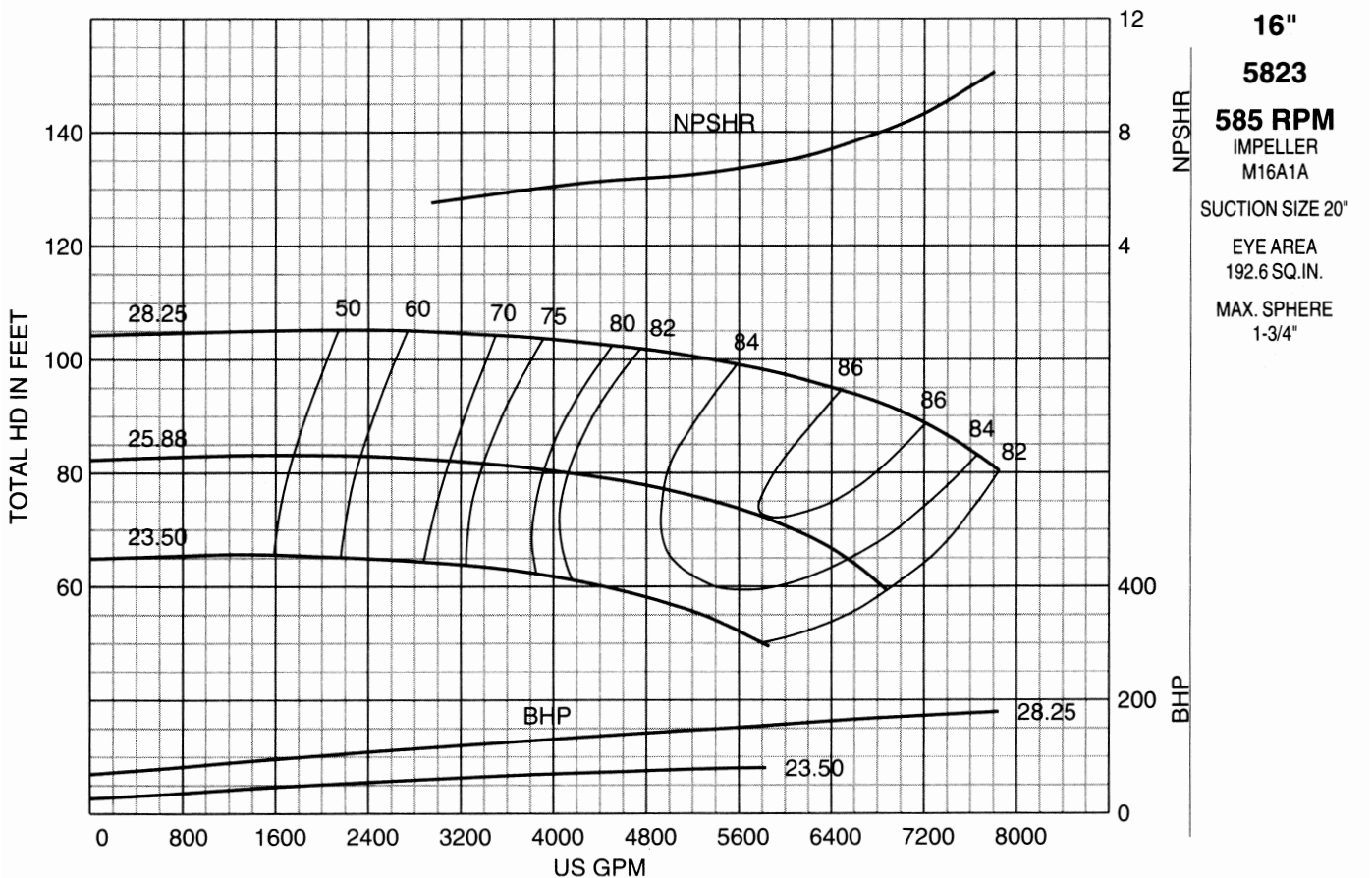
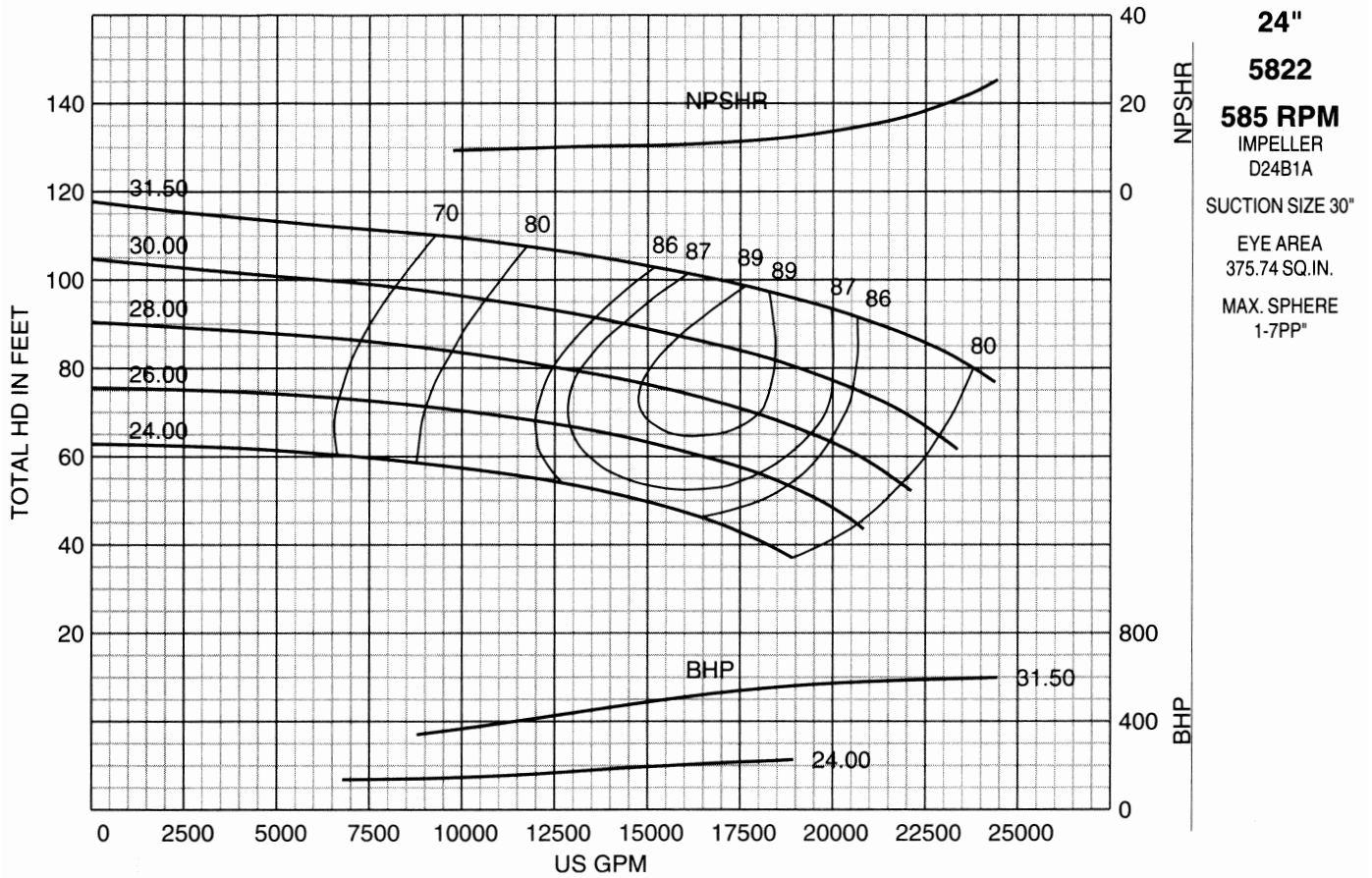

**20"**  
**5823**  
**585 RPM**  
 IMPELLER  
 D20A1A  
 SUCTION SIZE 24"  
 EYE AREA  
 317.77 SQ.IN.  
 MAX. SPHERE  
 2-1/4"

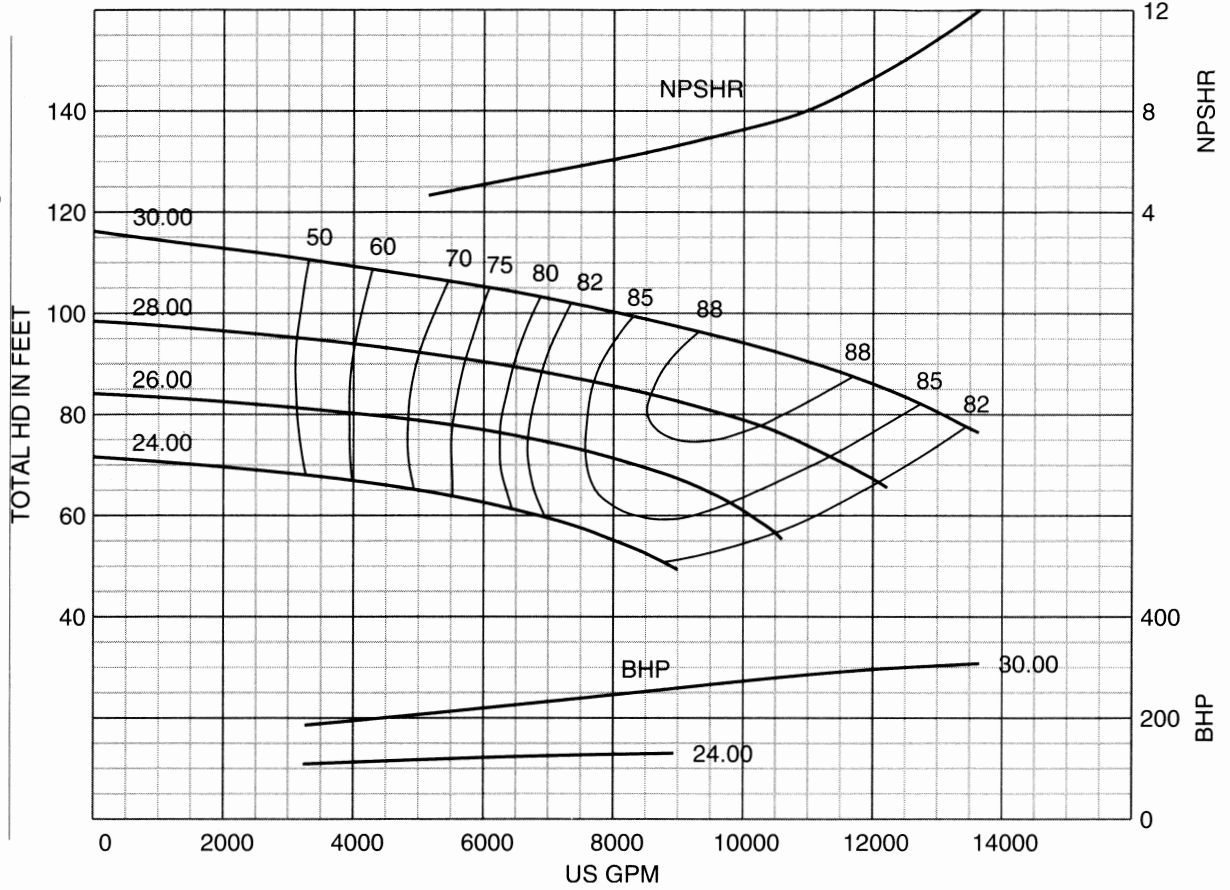

**30"**  
**5823**  
**585 RPM**  
 IMPELLER  
 D30A1A  
 SUCTION SIZE 36"  
 EYE AREA  
 815.4 SQ.IN.  
 MAX. SPHERE  
 2-3/4"

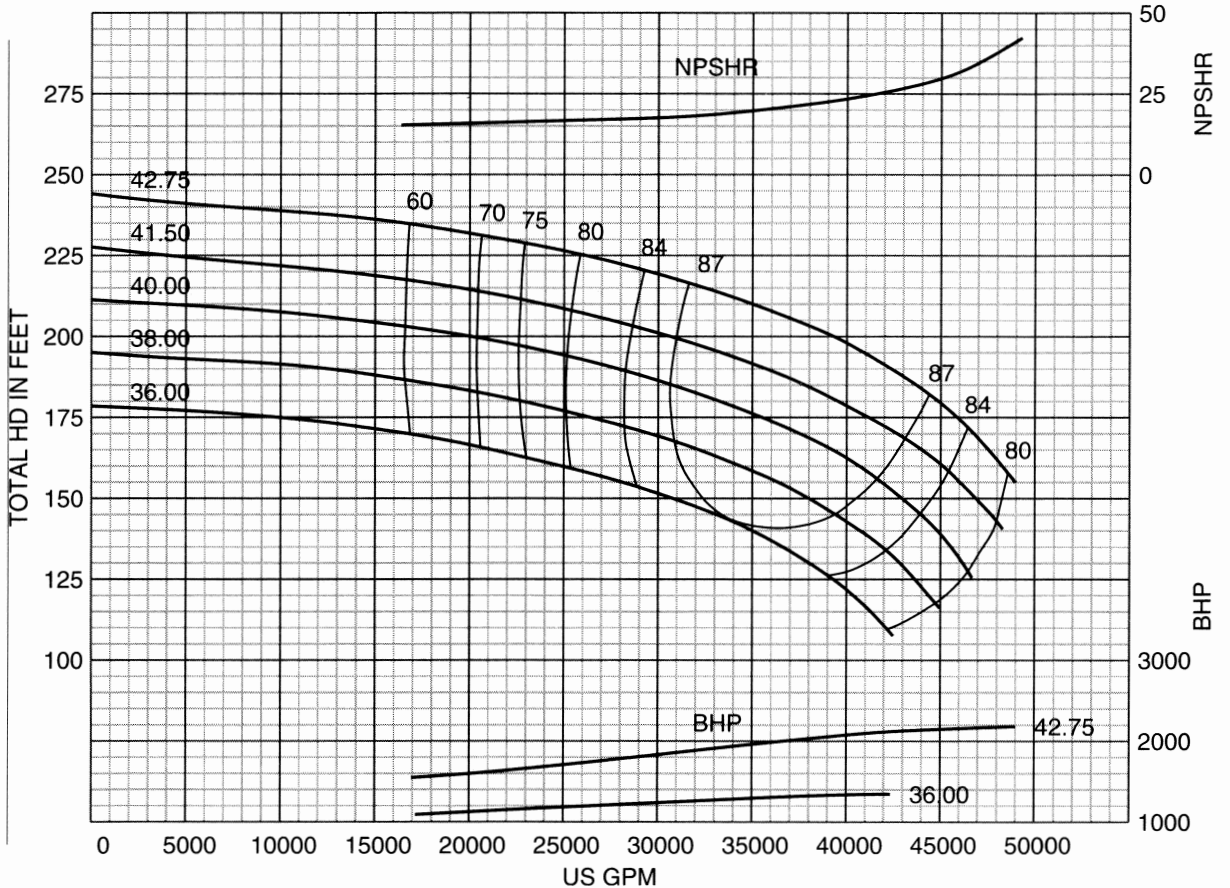



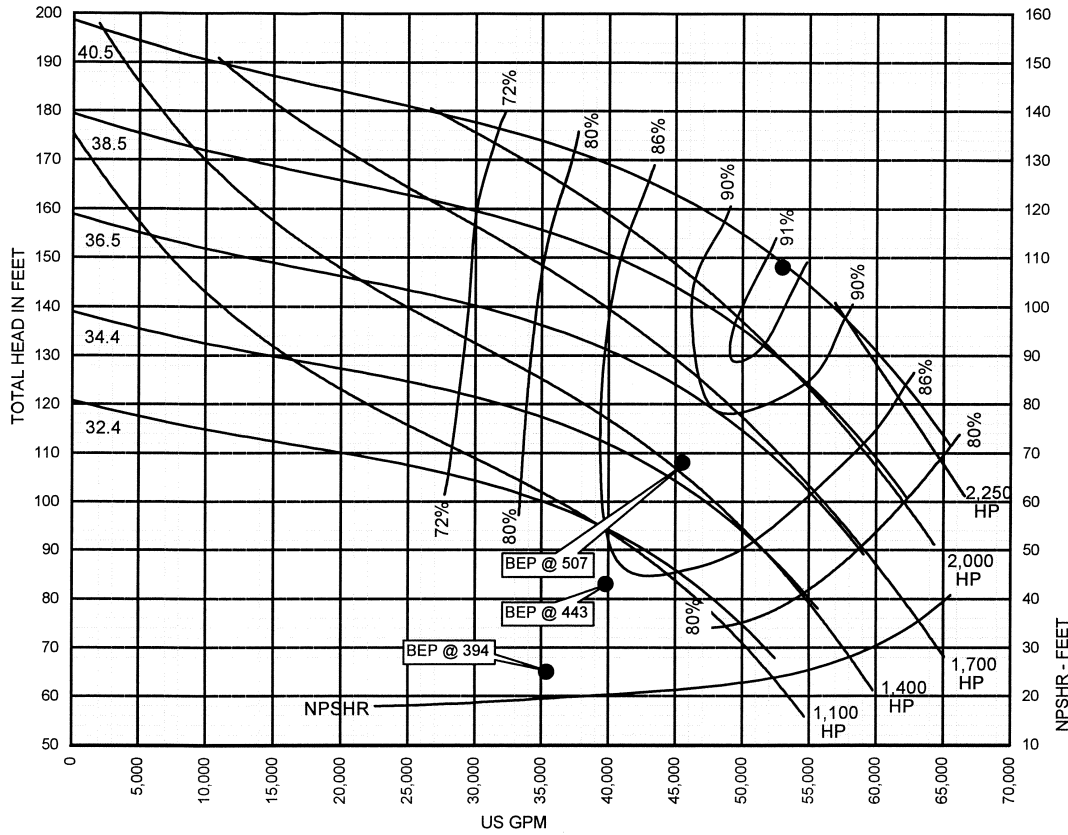

**30"**  
**5825A**

**591 RPM**

IMPELLER  
D30M1A

SUCTION SIZE  
36"

EYE AREA  
1238"

MAX SPHERE  
2.8"

 Notes:



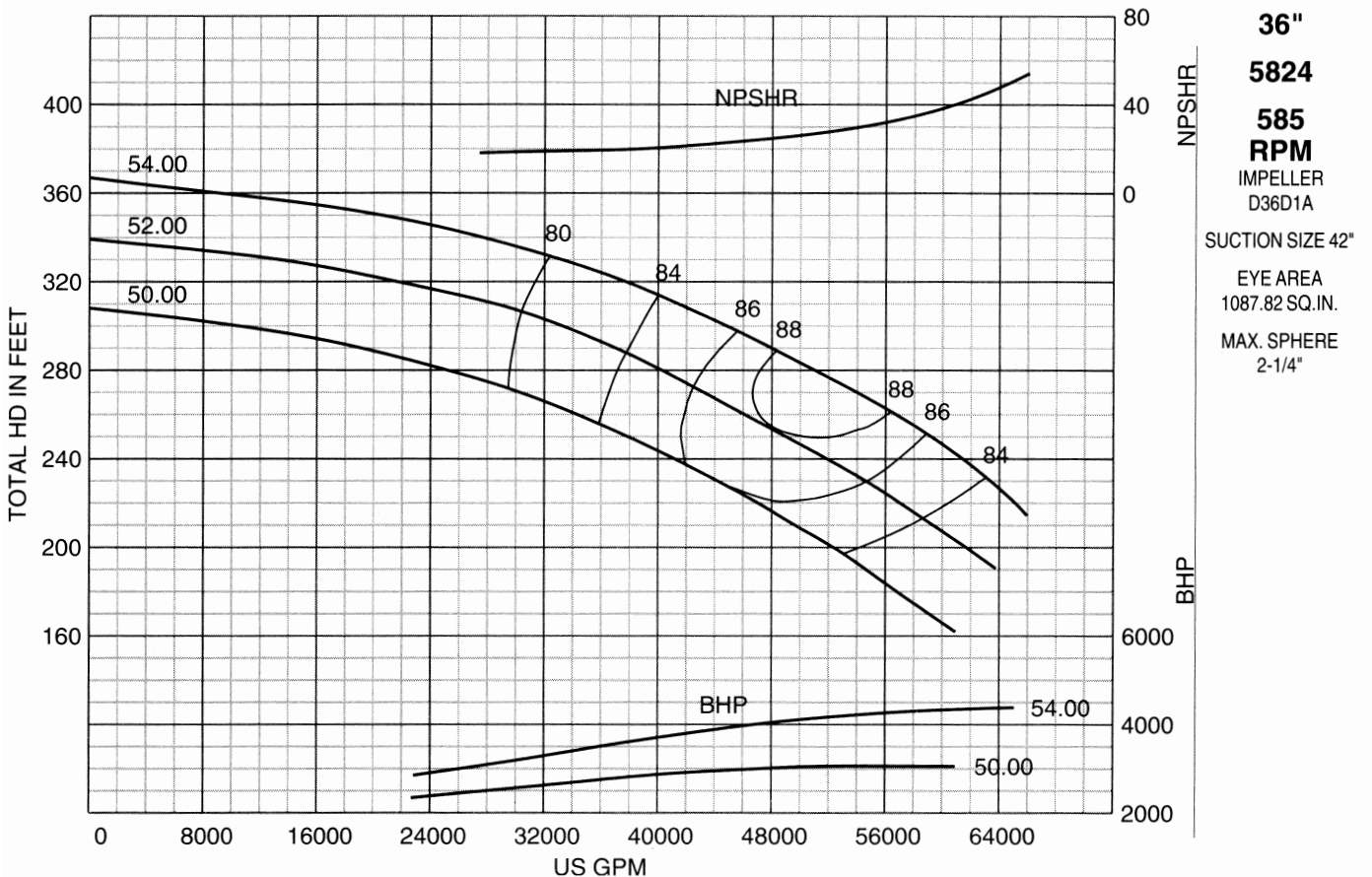
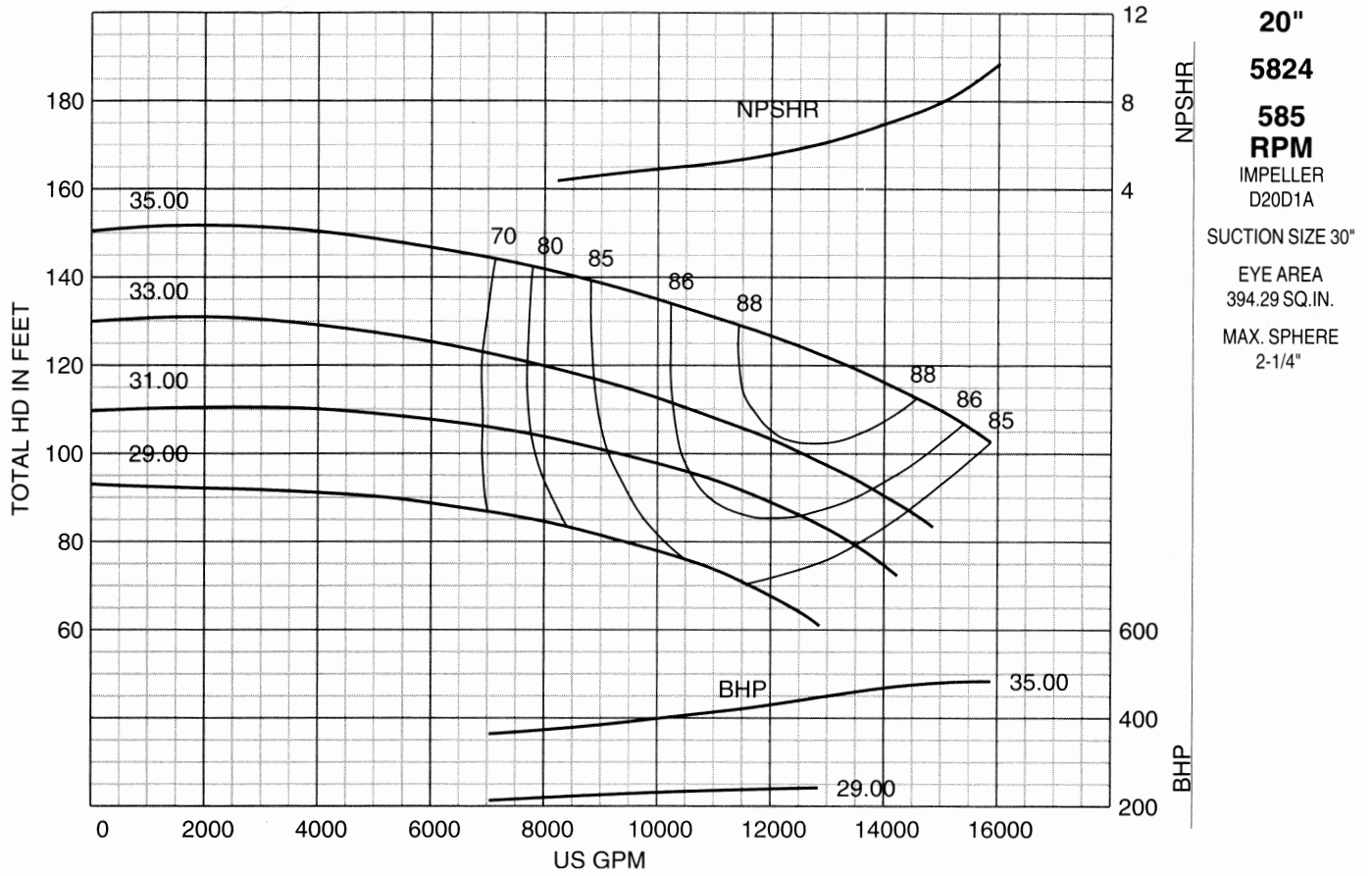

**24"**  
**5822**  
**505 RPM**  
 IMPELLER  
 D24B1A  
 SUCTION SIZE 30"  
 EYE AREA  
 375.74 SQ.IN.  
 MAX. SPHERE  
 1-7/8"

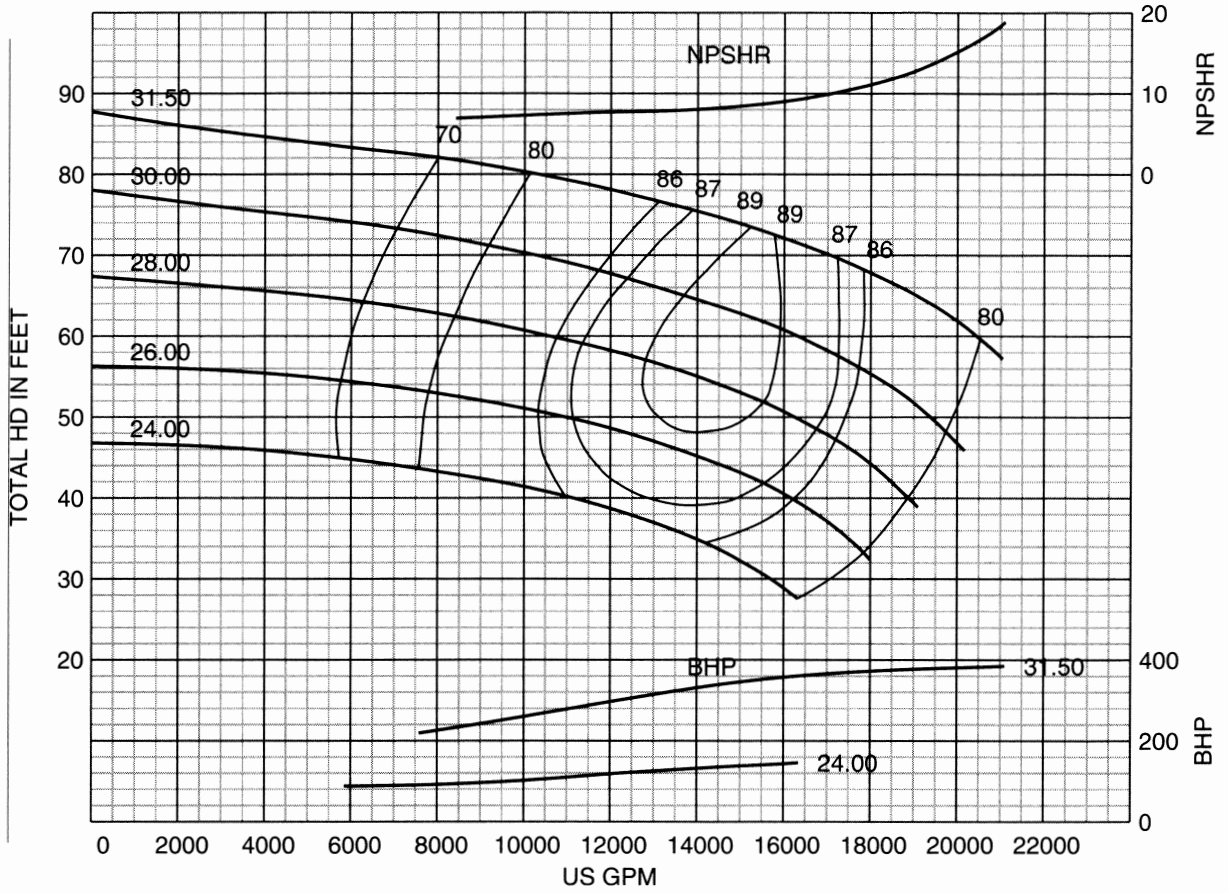

**30"**  
**5823**  
**505 RPM**  
 IMPELLER  
 D30A1A  
 SUCTION SIZE 36"  
 EYE AREA  
 815.4 SQ.IN.  
 MAX. SPHERE  
 2-3/4"

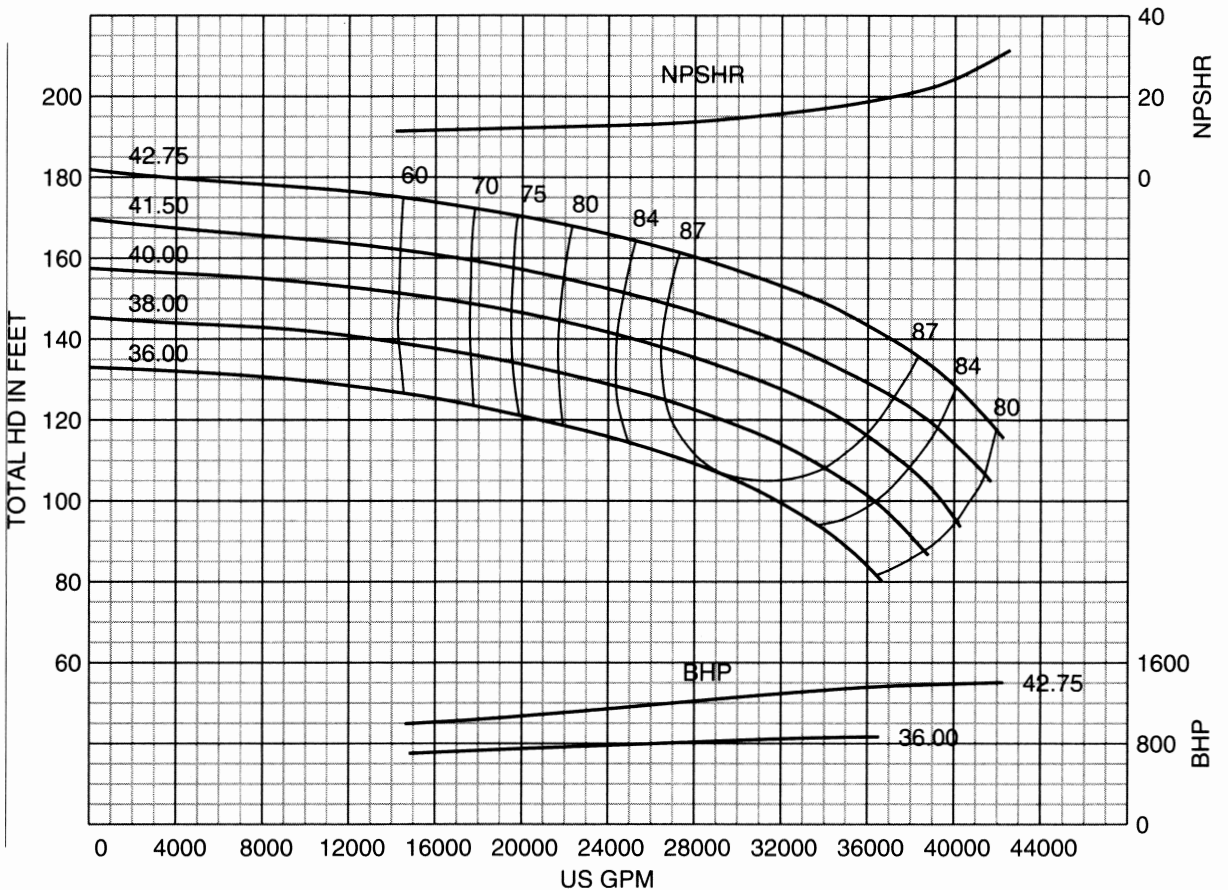



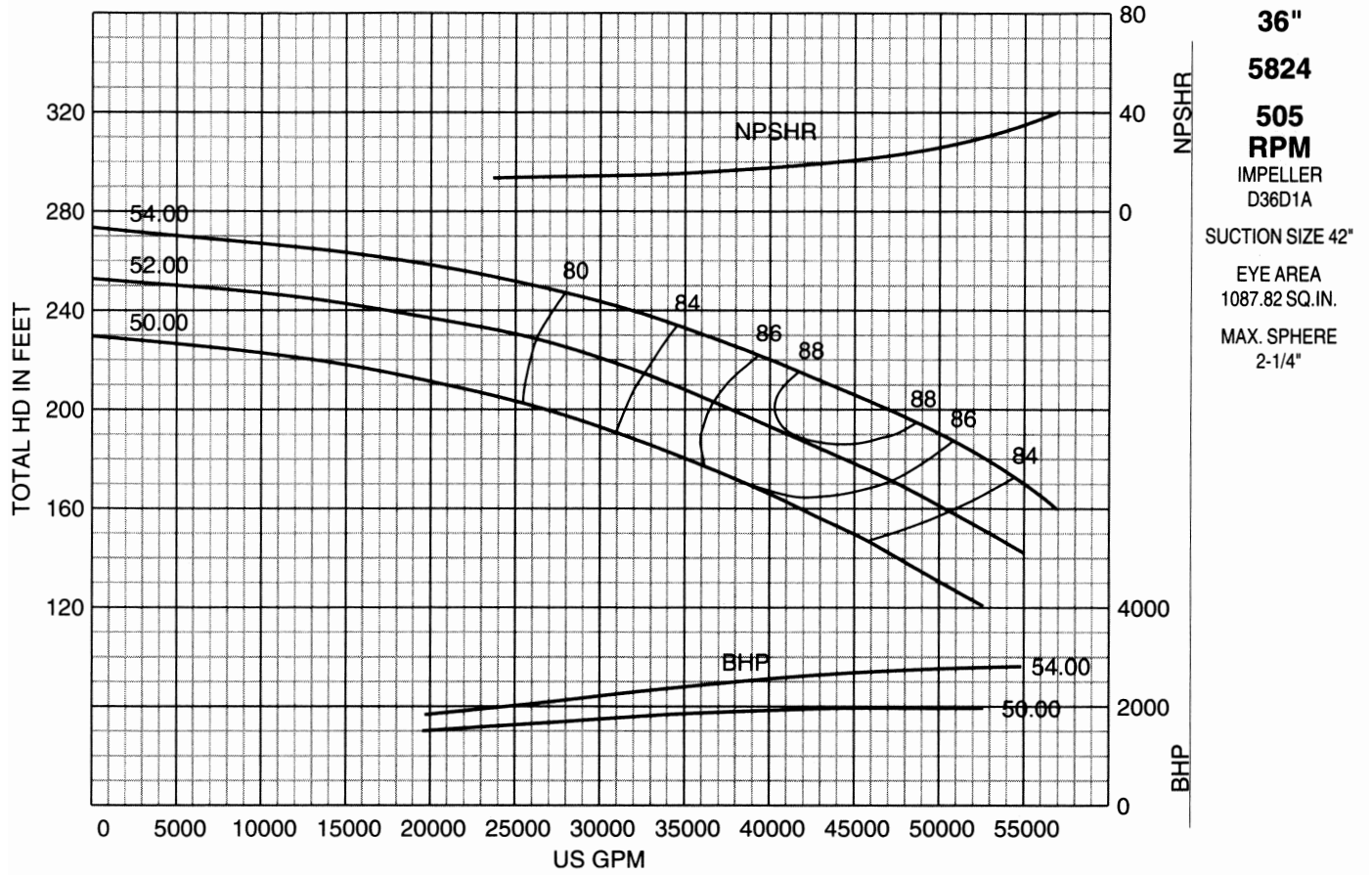

**24"**  
**5822**  
**440 RPM**  
 IMPELLER  
 D24B1A  
 SUCTION SIZE 30"  
 EYE AREA  
 375.74 SQ.IN.  
 MAX. SPHERE  
 1-7/8"

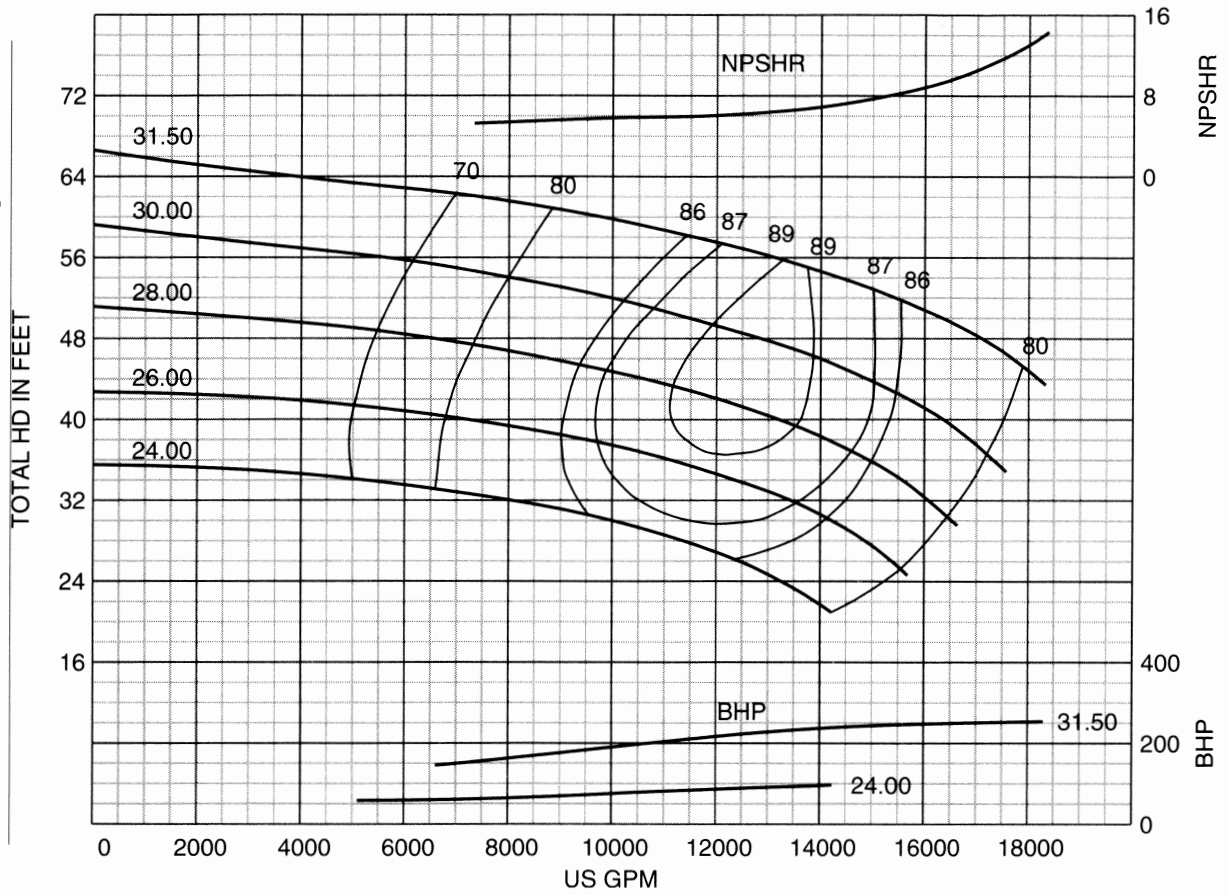

**30"**  
**5823**  
**440 RPM**  
 IMPELLER  
 D30A1A  
 SUCTION SIZE 36"  
 EYE AREA  
 815.4 SQ.IN.  
 MAX. SPHERE  
 2-3/4"

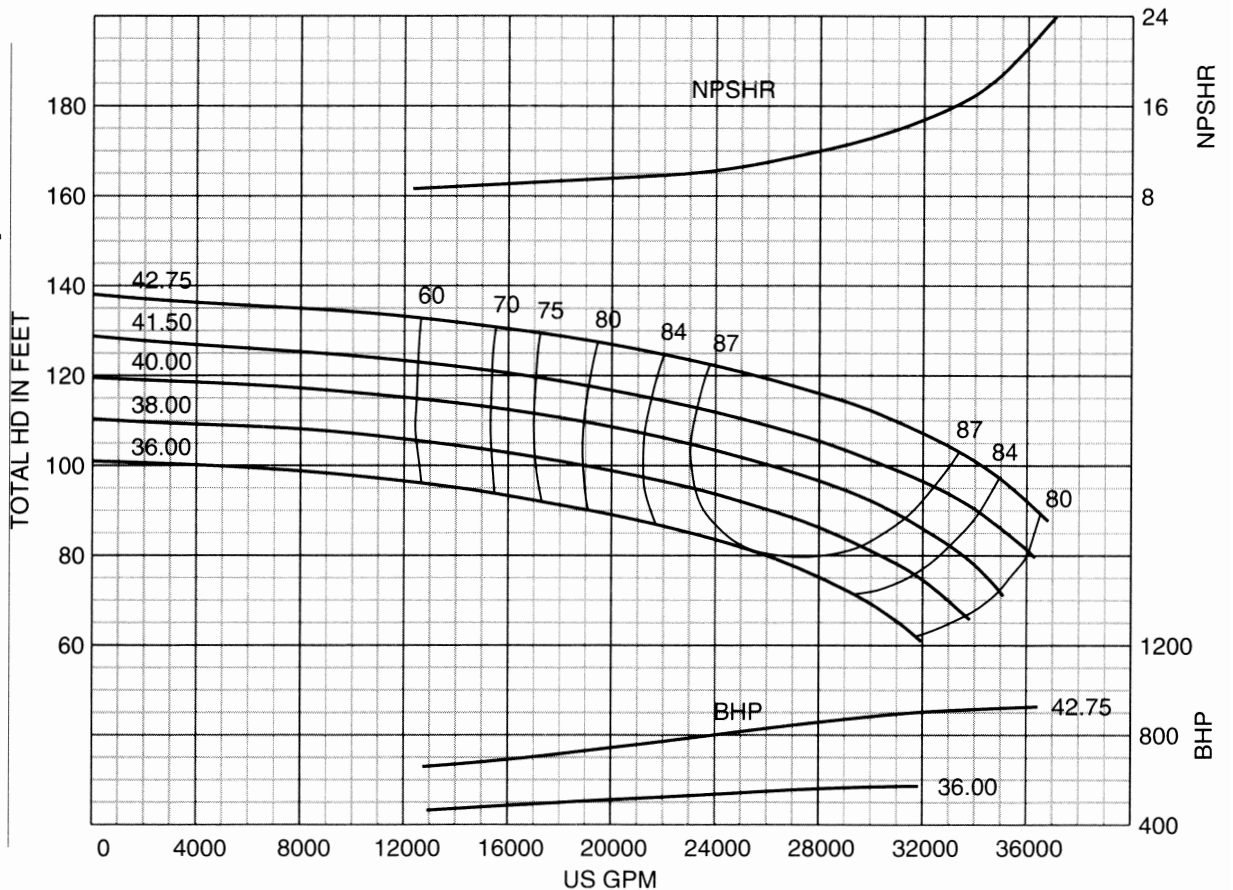



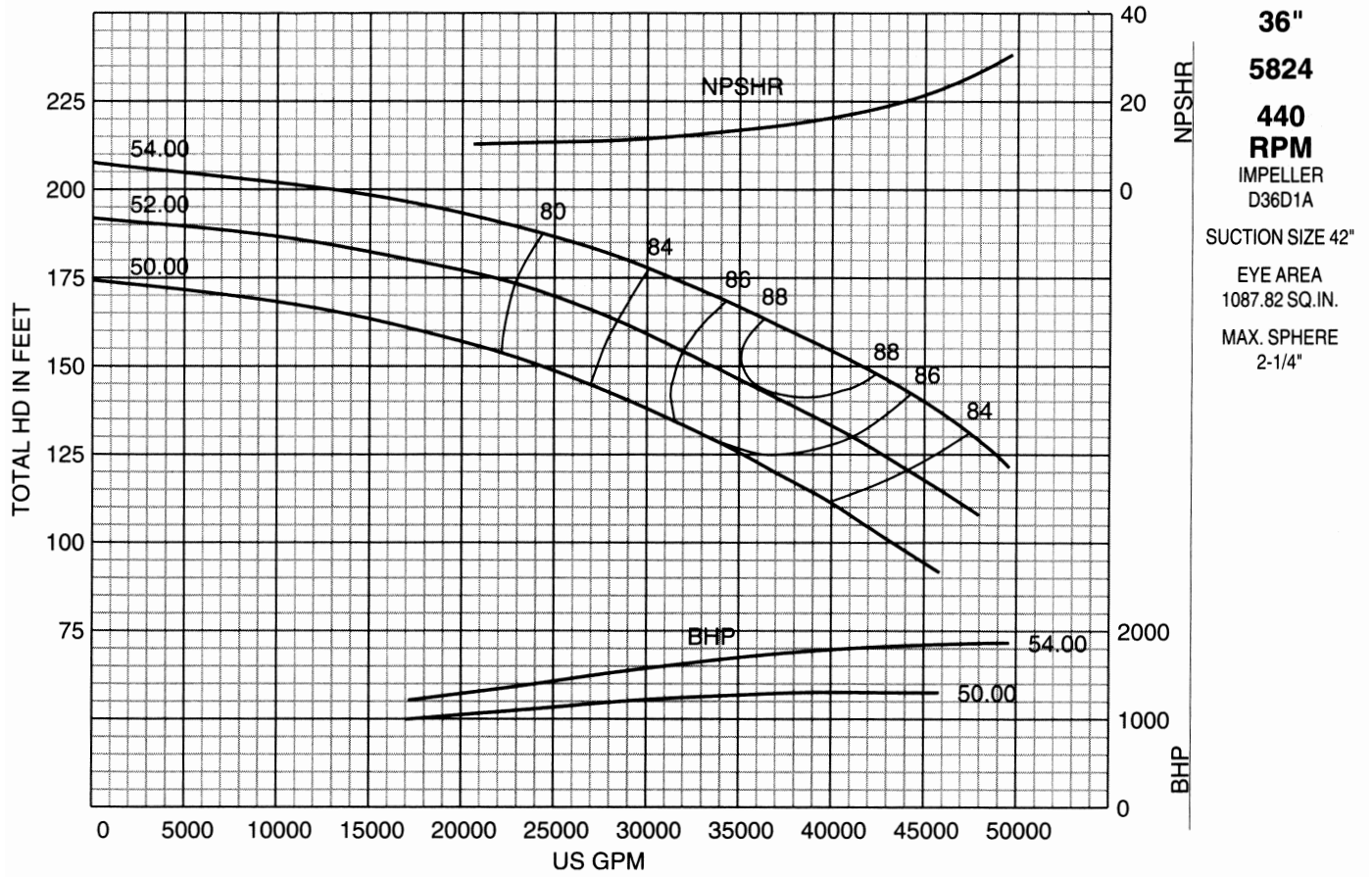

**36"**  
**5821**  
**390 RPM**  
 IMPELLER  
 D36C1A  
 SUCTION SIZE 42"  
 EYE AREA  
 1111.24 SQ.IN.  
 MAX SPHERE  
 2-1/2"

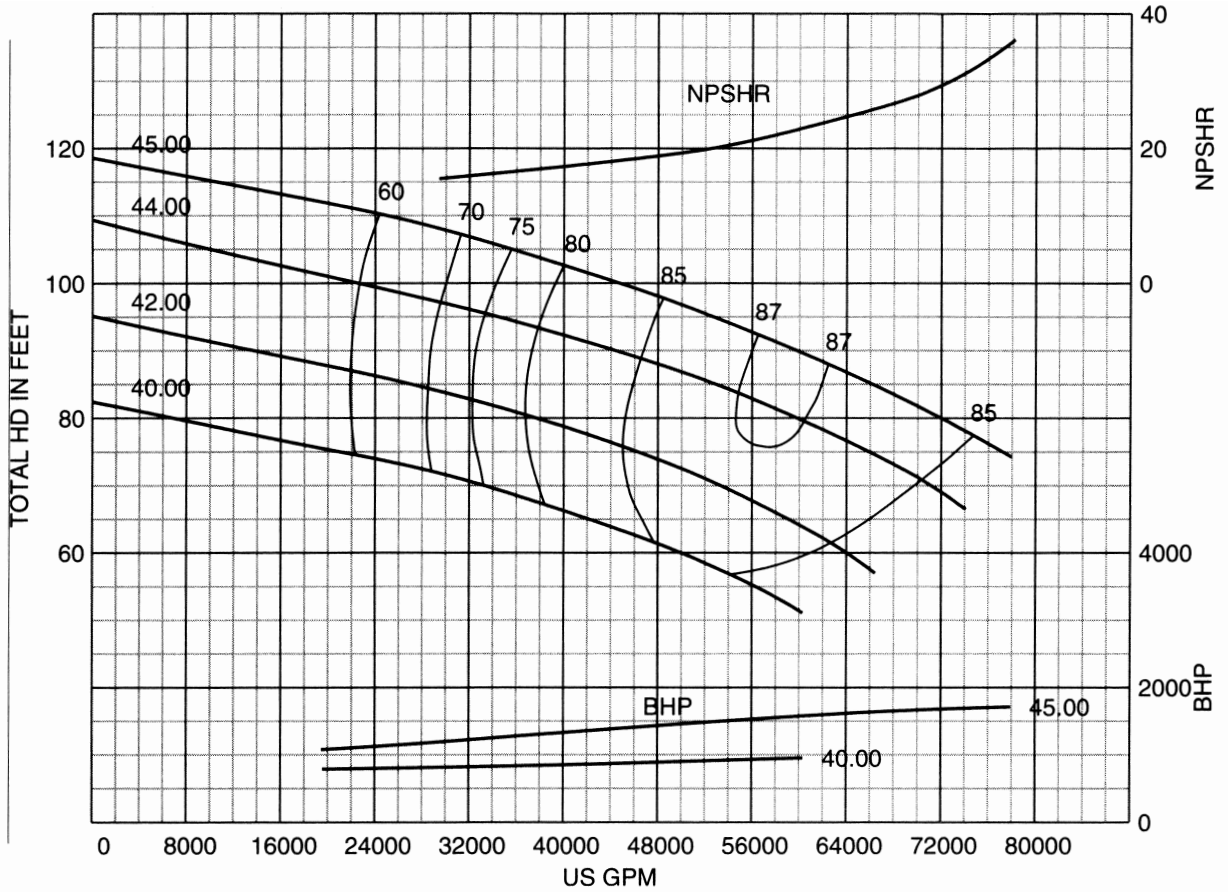

**36"**  
**5821**  
**350 RPM**  
 IMPELLER  
 D36C1A  
 SUCTION SIZE 42"  
 EYE AREA  
 1111.24 SQ.IN.  
 MAX SPHERE  
 2-1/2"

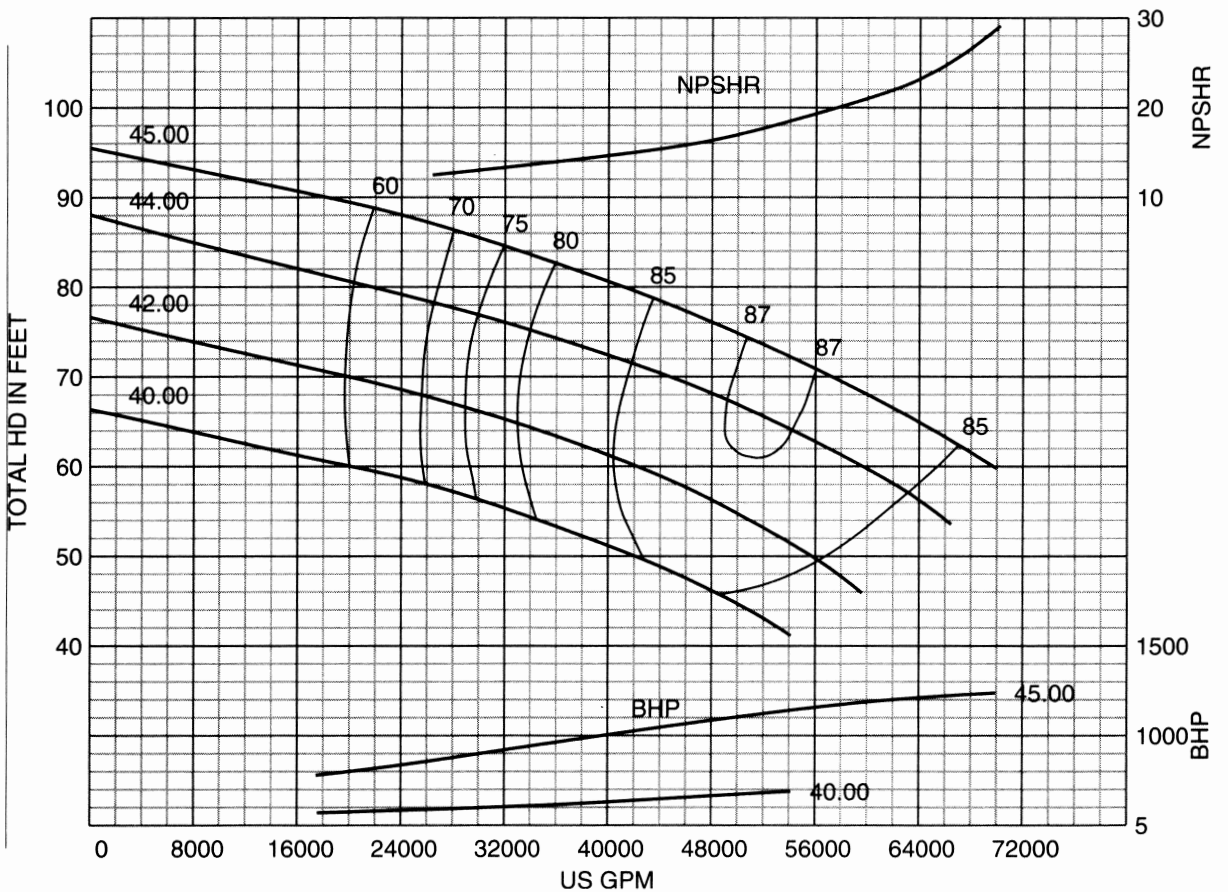



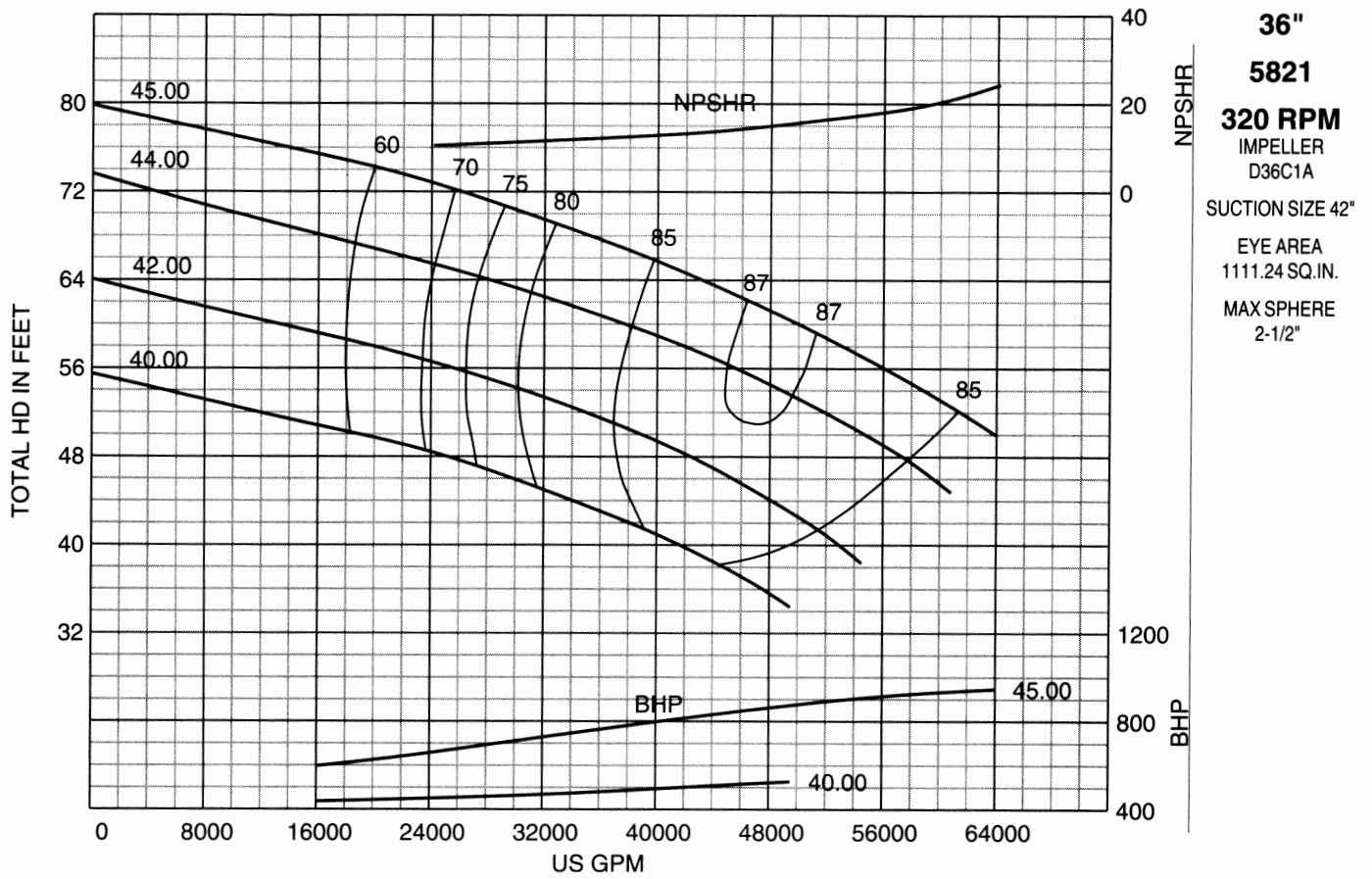

**THIS PAGE LEFT BLANK INTENTIONALLY**