



SHURFLO TRAIL KING™ II

RV/CARAVAN FRESH WATER PUMP – PRODUCT TECHNICAL DATA SHEET

OEM: 4009-101-A54
 AFTERMARKET: 4009-101-B54



APPLICATION:

Multi-fixture RV/Caravan fresh water pump installation.
 This pump may be used for general fresh water transfer

PUMP DESIGN:

Type: 4 Chamber Diaphragm pump
 Ports: 1/2"-14 NPSM-Male
 Liquid: 54°C [130°F] Max
 Dry-Prime: 1.82M [6 Feet]
 Run Dry: Yes
 Inlet Pressure: 2.0 Bar Max [30 PSI Max]

ELECTRICAL:

Motor: 12V DC Permanent Magnet, Intermittent Duty
 Protection: Thermal Overload, Automatic Restart
 Leads: 16 AWG, 25 cm [10"] Red +, 33 cm [13"] Black -
 Fuse: 5 Amp Recommended
 Control: Shut-Off 2.06 Bar [30 PSI] ± 0.13 Bar [2 PSI]
 Re-start 1.37 Bar [20 PSI] ± 0.13 Bar [2 PSI]
 Max By-Pass 2.55 Bar [37 PSI]

MATERIALS OF CONSTRUCTION:

Housings: Polypro
 Valves/Seals: EPDM
 Diaphragm: Santoprene
 Hardware: Stainless Steel and Zinc Plated Steel

AGENCY APPROVALS:

CSA, CE, e-Mark

SHIPPING INFORMATION:

Approx. Net Weight: 2.3 Kg [5 lbs.] ea.
 Carton Qty.: 12
 Approx. Carton Weight: 27 Kg [60 lbs.]
 Approx. Carton Size: 60.9 cm x 45.7 cm x 27.9 cm [24"L X 18"W X 11"H]

REPAIR KITS

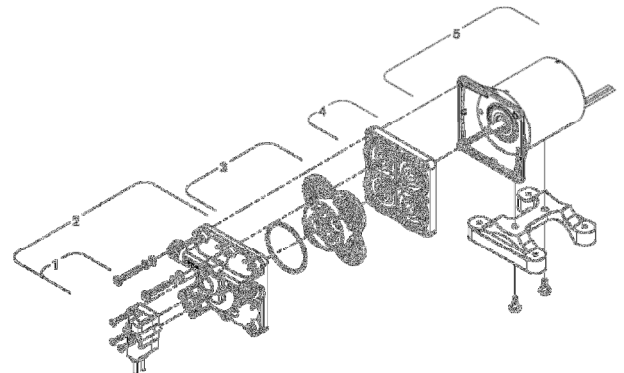

Number	Description	Part Number
*1	Pressure switch	94-890-00
*1,2	Upper assembly	94-890-07
3	Valve Assembly	94-800-01
4	Drive assembly	94-800-02
5	Motor	94-11-302-00CE
*1,2,3,4	Pump Head	94-890-05
Not Shown	Check Valve	94-800-03

*With preset switch adjustment

RELATED DOCUMENTS:

Catalog: MS-030-138
 Application Spec Guide: MS-020-005
 Installation Manual: 911-1038
 Retail Warranty: 911-1044

TYPICAL PERFORMANCE AT 12V

PRESSURE		FLOW		CURRENT
BAR	PSI	GPM	LPM	AMPS
0	0	3.0	11.3	1.85
0.4	6	2.3	8.70	2.54
0.7	10	1.93	7.30	2.92
1.1	16	1.03	3.89	3.44
1.4	20	0.54	2.04	3.80
1.9	27	0.0	0.0	4.14

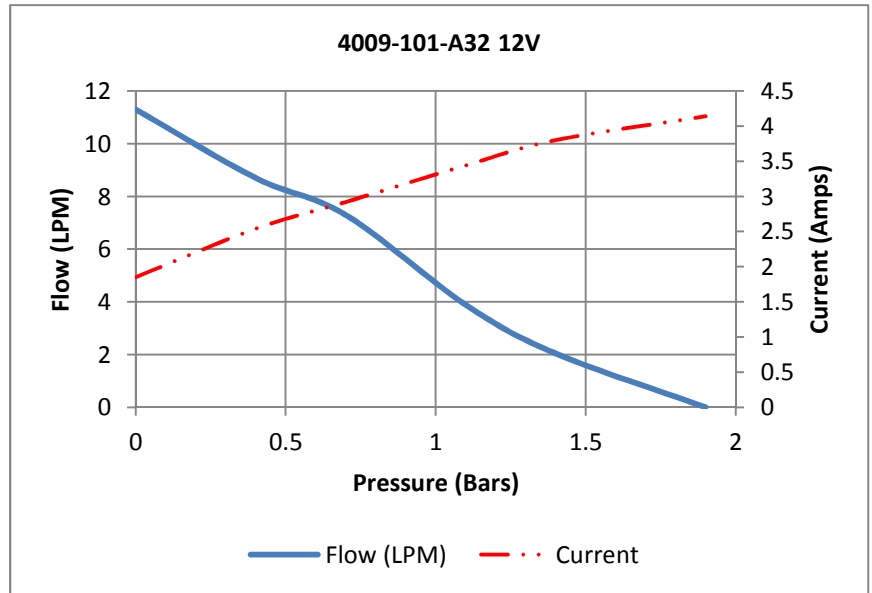

DIMENSIONS [mm]

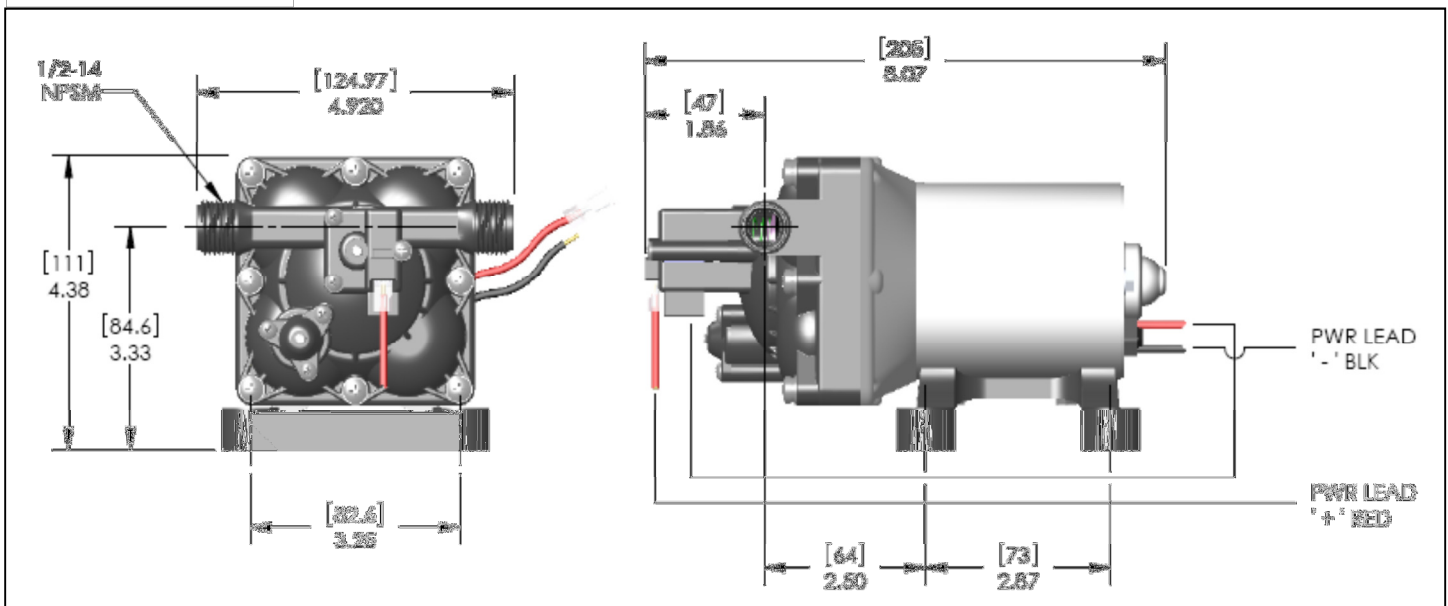

WATER PURIFICATION

3545 Harbor Gateway South, Suite 103, Costa Mesa, CA 92626, (800) 854-3218 www.SHURFLO.com

All Pentair trademarks and logos are owned by Pentair, Inc. All other brand or product names are trademarks or registered marks of their respective owners. Because we are continuously improving our products and services, Pentair reserves the right to change specifications without prior notice. Pentair is an equal opportunity employer.